

Singer 7-1
Singer 7-2
Singer 7-3
Singer 7-4
Singer 7-5
Singer 7-6
Singer 7-7
Singer 7-8
Singer 7-10
Singer 7-11
Singer 7-13
Singer 7-14
Singer 7-15
Singer 7-16
Singer 7-17
Singer 7-18
Singer 7-20
Singer 7-22

Singer 7-24
Singer 7-26
Singer 7-29
Singer 7-30
Singer 7-32
Singer 7-35
Singer 7-36
Singer 7-37
Singer 7-40
Singer 7-42
Singer 7-43
Singer 7-44
Singer 7-45
Singer 7-46
Singer 7-47
Singer 7-50
Singer 7-55

Form 8658—REVISED
April, 1933
PRINTED IN U. S. A.

LIST OF PARTS



MACHINES

**Nos. 7-1 to 7-8, 7-10, 7-11, 7-13 to 7-18
7-20, 7-22, 7-24, 7-26, 7-29, 7-30,
7-32, 7-35 to 7-37, 7-40, 7-42
to 7-47 and 7-50 to 7-55**

THE SINGER MANUFACTURING COMPANY

COPYRIGHT, U. S. A., 1916, 1918, 1920 and 1933
BY THE SINGER MANUFACTURING CO.
ALL RIGHTS RESERVED FOR ALL COUNTRIES

INSTRUCTIONS FOR OILING

To insure easy running and prevent unnecessary wear of the parts which are in movable contact, the machine requires oiling and when in continuous use, should be oiled at least twice each day by applying Singer Cloth and Leather Oil to all oil holes marked "Oil" and to all other oiling places.

Genuine Singer Needles should be used
in Singer Machines.
These Needles and their Containers
are marked with the
Company's Trade Mark "SIMANCO." 1

Needles in Containers marked
"For Singer Machines"
are not Singer made needles. 2

INDEX

	PAGE
ACCESSORIES.....	161
BELT SHIFTER No. 11945.....	160
“ “ “ 19994.....	161
BINDER (ADJUSTABLE) No. 11576.....	166
BINDERS ON SHANK.....	167
BOBBIN WINDERS.....	170
BRIDLE IRON.....	180
CORDER (ADJUSTABLE).....	167
DRIVING ATTACHMENTS.....	162
FOOT LIFTER PARTS.....	180
GUIDE (ADJUSTABLE) No. 19656.....	168
“ “ “ 19725.....	168
HEMMER ON SLIDE.....	168
“ “ SHANK.....	168
LAP SEAM FELLERS.....	169
“ “ GUIDE.....	169
MACHINE No. 7-1.....	9
“ “ 7-2.....	15
“ “ 7-3.....	16
“ “ 7-4.....	16
“ “ 7-5.....	17
“ “ 7-6.....	24
“ “ 7-7.....	24
“ “ 7-8.....	25
“ “ 7-10.....	26
“ “ 7-11.....	35
“ “ 7-13.....	44
“ “ 7-14.....	52
“ “ 7-15.....	59
“ “ 7-16.....	60
“ “ 7-17.....	67
“ “ 7-18.....	68
“ “ 7-20.....	68
“ “ 7-22.....	69
“ “ 7-24.....	78
“ “ 7-26.....	88
“ “ 7-29.....	96
“ “ 7-30.....	102
“ “ 7-32.....	111
“ “ 7-35.....	121
“ “ 7-36.....	121
“ “ 7-37.....	122
“ “ 7-40.....	123
“ “ 7-42.....	133
“ “ 7-43.....	141

INDEX—Continued

	PAGE
MACHINE No. 7-44.....	153
“ “ 7-45.....	153
“ “ 7-46.....	154
“ “ 7-47.....	154
“ “ 7-50.....	154
“ “ 7-51.....	155
“ “ 7-52.....	156
“ “ 7-53.....	156
“ “ 7-54.....	156
“ “ 7-55.....	158
NUMERICAL LIST OF PARTS.....	199
OBSOLETE PARTS.....	183
PRESSER FOOT.....	169
STRIP FOLDERS ON SHANKS.....	169
TABLE BELT GUIDE.....	181
THREAD UNWINDERS.....	181

INSTRUCTIONS FOR ORDERING

In ordering from this list, use **ONLY** the part NUMBER in the **FIRST** column.

The number stamped on a Sewing Machine part is in every case the number of the single part only.

Every combination of parts sent out as such has its specific number, which, although not stamped on the parts, must be used when ordering the combination.

Each number always indicates the **SAME PART** in whatever list it appears, or for whatever machine.

The letters after some of the numbers indicate the style of finish only, as follows:

- A—Hardened, Polished, Nickel Plated and Buffed
- B—Polished, Nickel Plated and Buffed
- C—Hardened Only
- D—Polished Only
- E—Soft, Not Polished
- F—Hardened and Polished
- H—Blued
- J—Nickel Plated Only
- K—Hardened and Nickel Plated
- L—Brass Plated
- M—Oxidized
- N—Japanned, Dull
- P—Japanned, Bright
- R—Merhized
- T—Copper Plated
- T. A.—Hardened, Polished, Copper and Nickel Plated and Buffed
- T. B.—Copper and Nickel Plated and Polished
- T. J.—Copper and Nickel Plated Only
- T. K.—Hardened, Copper and Nickel Plated
- T. M.—Copper Plated and Oxidized
- T. L.—Copper and Brass Plated
- U—Zinc Plated
- V—Silver Plated
- W—Polished and Nickel Plated
- Y—Black Nickel Plated Only
- Z—Chromium Plated
- Z. B.—Polished, Nickel Plated, Buffed and Chromium Plated
- Z. J.—Nickel and Chromium Plated

These letters **MUST BE USED** when they appear in the list; and **AFTER** the number as in the list.

In this series:

- 1 to 1500 and 50001 to 51500 are Screw Numbers
- 1501 to 1800 and 51501 to 51800 are Nut Numbers
- 1801 to 2000 and 51801 to 52000 are Roller Numbers
- 2001 to 50000 and 52001 and upward are numbers of Machine Parts

The figures in the second column refer only to the plates, illustrating the parts, and are **NOT TO BE USED** in ordering.

Parts marked with an asterisk (*) are furnished only when repairs are made at factory.

When ordering parts which differ as to **Gauge** (the distance between seams) the Gauge, as well as the **Number must be given** on order.

LIST OF PARTS COMPLETE

FOR

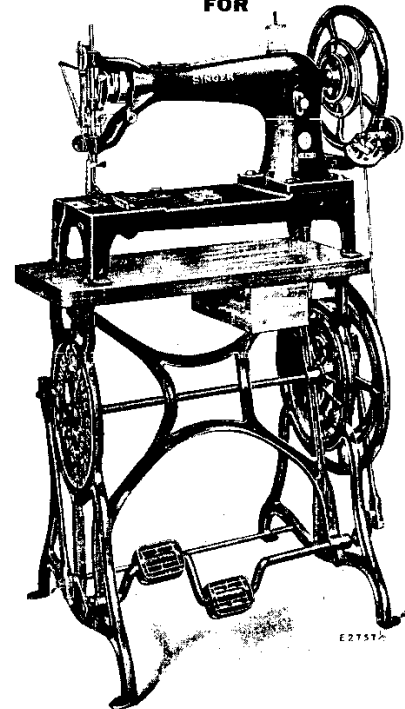

MACHINE NO. 7-1 ON TABLE NO. 5201 AND
STAND NO. 25207.

(FOR DESCRIPTION OF TABLE AND STAND SEE FORM 8801)

MACHINE No. 7-1

FOR PLAIN STITCHING, CARRIAGE TRIMMINGS, CUSHIONS,
SAILS, TENTS, ETC. STITCH $\frac{3}{32}$ IN. TO $\frac{1}{2}$ IN. LONG,
DROP FEED. FOR FOOT POWER STAND.

NO.	PLATE	NAME
*19959	—	Arm with 15404 and two 15405.....
8702	887	" Dowel Pin.....
127848	9608	" Oil Cup, for oiling Arm Shaft Front and Back Bearings.....
58564	9608	Arm Oil Tube, for oiling Arm Shaft Intermediate Bearing.....

NO.	PLATE	NAME
50348E	9619	Arm Screw.....
11353	825	" Shaft.....
11354	830	" " Bushing.....
437c	899	" " " Set Screw.....
11913	825	" Side Cover.....
65D	899	" " " Hinge Screw.....
8708	827	" Spool Pin.....
11241	858	" " " Washer (cloth).....
11358	896	Balance Wheel (two speed) with two 354c
354c	899	" " " Set Screw.....
*11359	—	Bed.....
24131	9608	" Oil Tube with 52045, for oiling Feed Rock Shaft (back) Bearing.....
58549	9608	Bed Oil Tube with 52045, for oiling Feed Lifting and Feed Rock Shaft (front) Bearings.....
52045	9608	Bed Oil Tube Packing (felt).....
11363	825	Crank Connecting Rod.....
565c	898	" " " " Hinge Screw....
1513J	890	" " " " " " Nut
11365	828	Feed Bar.....
307c	898	" " " Screw Center.....
56814	—	" " " " 307c with 1513J.
1513J	890	" " " " " Nut.....
11367	830	" Cam with two 445c.....
445c	900	" " " Set Screw.....
11368	830	" Connecting Link.....
565c	898	" " " " Hinge Screw....
1513J	890	" " " " " " Nut..
11369	4416	" Dog, 14 teeth (10 teeth to the inch) for 11433 and 58241.....
166E	899	Feed Dog Screw.....
11370	825	" Forked Connection.....
565c	898	" " " " Hinge Screw....
1513J	890	" " " " " " Nut
19970	4420	Feed Lifting Rock Shaft with 134E, 2022 and 19967.....
19971	—	Feed Lifting Rock Shaft complete, Nos. 19812 and 19970.....
19812	4421	Feed Lifting Rock Shaft Crank with 346E and 1861.....
346E	4453	Feed Lifting Rock Shaft Crank Clamp- ing Screw.....
1861	862	Feed Lifting Rock Shaft Crank Roller and Stud.....
564c	898	Feed Lifting Rock Shaft Screw Center

NO.	PLATE	NAME
58384	—	Feed Lifting Rock Shaft Screw Center 564c with 1508J.....
1508J	890	Feed Lifting Rock Shaft Screw Center Nut.....
19967	861	Feed Lifting Rock Shaft Wearing Block
2022	887	" " " " " "
		Position Pin.....
134E	900	Feed Lifting Rock Shaft Wearing Block Screw.....
11375	830	Feed Regulator.....
568E	898	" " " Hinge Screw.....
50322D	4489	" " " Thumb Screw.....
58233	4490	" Rock Shaft.....
58234	—	Feed Rock Shaft complete, Nos. 58233 and 58235.....
58235	4491	Feed Rock Shaft Crank with 346E.....
346E	4453	" " " " Clamping Screw
564c	898	" " " " Screw Center.....
58384	—	" " " " " " 564c with 1508J.....
1508J	890	Feed Rock Shaft Screw Center Nut....
258E1	894	Guide (6 in. face).....
254D	902	" Thumb Screw.....
11380	828	Needle Bar.....
*11539	856	" " " Connecting Link.....
566c	898	" " " " " Hinge Screw
1513J	890	" " " " " " " "
		Nut.....
11383	887	Needle Bar Connecting Stud with two 445F.....
19981	—	Needle Bar Connecting Stud 11383 with 11539.....
445F	900	Needle Bar Connecting Stud Set Screw..
258F	899	" " " Screw Bushing.....
19702	890	" Clamp with 680F and 11385.....
*11385	890	" " " Gib.....
680F	862	" " " Thumb Screw.....
58253	—	Oil Cup.....
11917	825	" " " Cover.....
9084	889	" " " " Hinge Pin.....
2205	887	" " " " Latch Spring.....
207F	901	" " " " " " Screw.....
8953	874	" or Wax Stripper (felt).....
11918	888	" " " " " Washer (steel) for 11917.....
8482	890	Oil or Wax Stripper Washer (steel) for 58253.....

NO.	PLATE	NAME
207F	901	Oil or Wax Stripper Washer Screw.....
58254	4490	Oil Cup complete, Nos. 2205, 8482, 9084, 11917, 11918, 58253, two 8953 and three 207F.....
134E	900	Oil Cup Screw.....
58573	9625	Oscillating Rock Shaft.....
58566	—	Oscillating Rock Shaft complete, Nos. 1508J, 11165, 51237c, 58570, 58573 and 58586.....
58585	9625	Oscillating Rock Shaft Hinge Pin.....
58586	—	“ “ “ “ “ 58585 with 1508J.....
1508J	890	Oscillating Rock Shaft Hinge Pin Nut...
51237c	9619	“ “ “ “ “ Screw Bearing.....
1508J	890	Oscillating Rock Shaft Hinge Pin Screw Bearing Nut.....
11165	897	Oscillating Rock Shaft Oil Pad.....
58567	—	“ “ “ “ Tube with 58569.....
58570	9616	Oscillating Rock Shaft Oil Tube com- plete, Nos. 58567, 58568 and 127848..
58568	9616	Oscillating Rock Shaft Oil Tube Joint...
127848	9608	“ “ “ “ “ Oil Cup
*58569	—	“ “ “ “ “ Sleeve..
11850	825	“ Shaft.....
11393	887	“ “ Collar with two 453c...
453c	899	“ “ “ Set Screw.....
11848	—	“ “ Crank.....
19696	4421	Oscillating Shaft Crank complete, Nos. 453c, 1513J, 5868 and 11848.....
40025	4492	Oscillating Shaft Crank Pin.....
453c	899	“ “ “ Set Screw.....
9119	4421	“ “ “ Slide Block.....
5868	4421	Oscillating Shaft Crank Slide Block com- plete, Nos. 190E, 1054c, 5968 and 9119.
190E	899	Oscillating Shaft Crank Slide Block Cap Screw.....
5968	887	Oscillating Shaft Crank Slide Block Cap Screw Washer.....
1054c	4421	Oscillating Shaft Crank Slide Block Screw Stud.....
1513J	890	Oscillating Shaft Crank Slide Block Screw Stud Nut.....
11402	828	Presser Bar.....
11404	827	“ “ Guide Bracket with 159E, 353c and 453c.....

NO.	PLATE	NAME
159E	901	Presser Bar Guide Bracket Adjusting Screw.....
453c	899	Presser Bar Guide Bracket Set Screw....
11405	830	“ “ “ “ Guide.....
381E	899	“ “ “ “ “ Screw
11909	830	“ “ Lifter with 8761 and 8763...
8760	888	“ “ “ Friction Washer.....
16D	899	“ “ “ Hinge Screw.....
8761	890	“ “ “ Stop Pin.....
11906	827	“ “ Lifting Link.....
353c	899	“ “ “ “ Cap Screw.....
8763	890	“ “ “ “ Hinge Stud
8973	862	“ “ “ “ “ “
43267	4492	Pin..... Presser Bar Lifting Link Hinge Stud Washer.....
258E	899	Presser Bar Screw Bushing.....
11409	827	“ “ Spring.....
11411	887	“ “ “ Collar with 453c.....
453c	899	“ “ “ “ Set Screw.....
11412	827	“ Foot with 362F.....
362F	899	“ “ Screw.....
252E	898	Pressure Regulating Thumb Screw.....
1929	907	Roller, 1¼ in. diam., with 373F and 1518J.....
19650	907	Roller Arm.....
423F	907	“ “ Adjusting Screw.....
1520F	907	“ “ “ “ Nut.....
19651	907	“ “ Bracket with 362F.....
362F	907	“ “ “ Set Screw.....
8773	907	“ “ Lock Spring.....
191F	907	“ “ “ “ Screw.....
315F	907	“ “ Screw Center.....
1518J	907	“ “ “ “ Nut.....
19652	4422	Roller Presser complete, 1¼ in. roller, Nos. 191F, 423F, 1520F, 1929, 8773, 19650, 19651 and two each 315F and 1518J.....
373F	907	Roller Screw.....
1518J	907	“ “ Nut.....
11910	7268	Shuttle Bobbin.....
19977	7268	“ “ Cylinder.....
58213	—	“ “ “ 19977 with 773F and 19979.....
58527	9621	Shuttle Cylinder Hinge Pin.....
58979	9611	“ “ Latch.....
12002	7268	“ “ “ Pin.....

14 PARTS FOR MACHINE No. 7-1

NO.	PLATE	NAME
122419	9621	Shuttle Cylinder Latch Spring.....
58523	9612	“ “ Frame.....
58524	—	“ “ 58523 with 12002, 58979 and 122419.....
773F	7268	Shuttle Tension Regulating Screw.....
19979	7268	“ “ Spring.....
58525	9613	Shuttle (cylinder) 3 in. diam., complete, Nos. 11910, 58213, 58524 and 58527...
11856	830	Shuttle Driver with 453c.....
2117	890	“ “ Pin.....
453c	899	“ “ Set Screw.....
11832	830	“ Race Back.....
11833	889	“ “ “ Position Pin.....
19577	864	“ “ “ Spring.....
32D	901	“ “ “ Screw.....
11835	—	“ “ Body.....
11836	825	Shuttle Race complete, Nos. 32D, 11832, 11835, 19577 and two 11833.....
134E	900	Shuttle Race Screw.....
11837	825	“ “ Frame with 11838.....
670E	862	“ “ “ Clamping Screw....
11838	889	“ “ “ Position Pin.....
11418	858	“ “ Slide (left).....
11500	851	“ “ “ (right).....
180D	901	“ “ “ Screw.....
11421	887	Tension Bracket.....
190E	899	“ “ Screw.....
8879	887	“ Friction Washer (cloth).....
11423	888	“ “ “ (steel).....
1560c	903	“ Regulating Thumb Nut.....
8905	887	“ “ “ Washer.....
411E	898	“ Screw Stud.....
58589	—	“ “ “ 411E with 1560c....
11422	888	“ Spring.....
11044	897	“ Wheel.....
11420	—	Tension (wheel) complete, Nos. 8905, 11044, 11422, 11423, 58589 and two 8879.....
11424	888	Thread Eyelet (front of arm).....
11950	888	“ “ (side of arm).....
2102	888	“ Retaining Disc.....
1560c	903	“ “ Regulating Thumb Nut.....
8905	887	“ “ “ “ Washer.....
686E	902	Thread Retaining Screw Stud.....
58590	—	“ “ “ “ 686E with 1560c.....

PARTS FOR MACHINE No. 7-1 15

NO.	PLATE	NAME
2103	888	Thread Retaining Spring.....
11041	—	Thread Retainer complete, Nos. 2103, 8905, 58590 and two 2102.....
11428	827	Thread Take-up Cam with two 434c....
8873	887	“ “ “ Pin.....
434c	899	“ “ “ Set Screw.....
58295	—	“ “ Lever.....
58296	4493	“ “ “ 58295 with 1995..
58320	—	“ “ “ 58296 with 50437D
50437D	4494	“ “ “ Hinge Screw.....
1995	4452	“ “ “ Roller and Screw Stud with 1518J.....
1518J	907	Thread Take-up Lever Roller and Screw Stud Nut.....
11052	887	Thread Take-up Spring.....
11431	888	“ “ “ Regulator Plate
190E	899	“ “ “ “ “ Adjusting Screw.....
11432	—	Throat Plate Body for 11433 and 58241.
11434	4416	“ “ Needle Plate (round needle hole) for 11433.....
11435	4416	Throat Plate Needle Plate (oblong needle hole) for 58241.....
219F	901	Throat Plate Needle Plate Screw.....
11433	4416	Throat Plate complete for 11369, Nos. 219F, 11432 and 11434.....
58241	—	Throat Plate complete for 11369, Nos. 219F, 11432 and 11435.....
381D	899	Throat Plate Screw.....
*15404	—	Trade Mark.....
15405	4492	“ “ Rivet.....

MACHINE No. 7-2

FOR POWER TABLE

FOR UNDER DRIVER

This Machine is the same as No. 7-1
with the following exception:

NO.	PLATE	NAME
58411	9631	Balance Wheel with two 354c, in place of 11358.....

MACHINE No. 7-3

FOR POWER TABLE. HAS S. D. A.

This Machine is the same as No. 7-1
with the following exceptions:

NO.	PLATE	NAME
58329	4495	Arm Shaft, in place of 11353.....
949E	4494	" " Screw.....
9842	4492	" " " Washer.....
122301	—	Balance Wheel with two 354c.....
122302	4496	" " 122301 with 11442, 122469, two 1402E and four 401E, in place of 11358.....
25362	9621	Balance Wheel Ball, size $\frac{3}{8}$ in.....
122303	—	" " " Ring.....
122304	4493	" " " " 122303 with eighteen 25362.....
122306	4493	Balance Wheel Ball Washer (left).....
122469	9616	" " " " (right).....
1402E	4494	" " " " Screw
11442	896	" " Friction Washer (paper)...
401E	899	" " " " Screw....

MACHINE No. 7-4

HAS BELT SHIFTER FOR FLAT BELT

This Machine is the same as No. 7-1
with the following exceptions:

NO.	PLATE	NAME
11878	838	Arm Shaft, in place of 11353.....
58407	9631	Balance Wheel and Pulley (tight) with two 354c, in place of 11358.....

LIST OF PARTS COMPLETE FOR

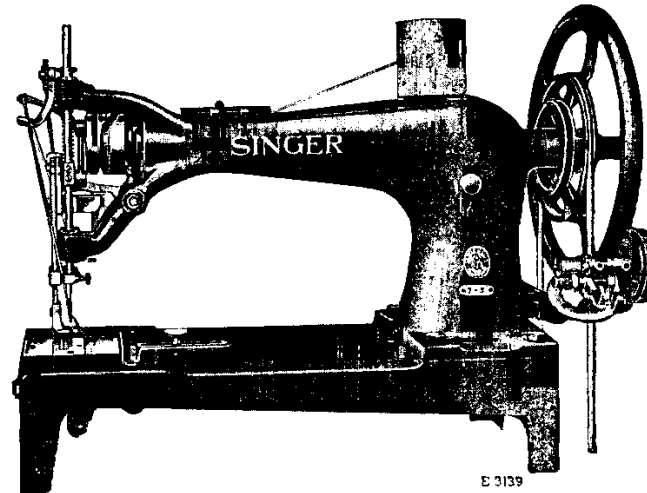

MACHINE No. 7-5

FOR HEAVY BAGS, CARPET MITRES, LEATHER CASES, HORSE
COLLARS, WAGON COVERS, PLUSH CUSHIONS, HARNESS,
SAILS, TENTS, ETC. STITCH $\frac{3}{8}$ IN. TO $\frac{1}{2}$ IN. LONG,
DROP FEED, VIBRATING PRESSER FOOT. FOR FOOT
POWER STAND.

NO.	PLATE	NAME
*19959	—	Arm with 15404 and two 15405.....
8702	887	" Dowel Pin.....
127848	9608	" Oil Cup, for oiling Arm Shaft Front and Back Bearings.....
58564	9608	Arm Oil Tube, for oiling Arm Shaft Inter- mediate Bearing.....
50348E	9619	Arm Screw.....
11353	825	" Shaft.....
11354	830	" " Bushing.....
437C	899	" " " Set Screw.....
11913	825	" Side Cover.....
65D	899	" " " Hinge Screw.....
8708	827	" Spool Pin.....
11241	858	" " " Washer (cloth).....
11358	896	Balance Wheel (two speed) with two 354c
354c	899	" " " Set Screw.....

NO.	PLATE	NAME
*11359	---	Bed.....
24131	9608	" Oil Tube with 52045, for oiling Feed Rock Shaft (back) Bearing.....
58549	9608	Bed Oil Tube with 52045, for oiling Feed Lifting and Feed Rock Shaft (front) Bearings.....
52045	9608	Bed Oil Tube Packing (felt).....
11363	825	Crank Connecting Rod.....
565c	898	" " " Hinge Screw.....
1513j	890	" " " " " Nut..
11365	828	Feed Bar.....
307c	898	" " Screw Center.....
56814	---	" " " " 307c with 1513j..
1513j	890	" " " " Nut.....
11367	830	" Cam with two 445c.....
445c	900	" " Set Screw.....
11368	830	" Connecting Link.....
565c	898	" " " Hinge Screw.....
1513j	890	" " " " " Nut..
11369	4416	" Dog, 14 teeth (10 teeth to the inch) for 11433 and 58241.....
19872	4424	Feed Dog, 15 teeth (10 teeth to the inch) for general work, for 19875.....
166E	899	Feed Dog Screw.....
11370	825	" Forked Connection.....
565c	898	" " " Hinge Screw.....
1513j	890	" " " " " Nut
19970	4420	" Lifting Rock Shaft with 134E, 2022 and 19967.....
19971	---	Feed Lifting Rock Shaft complete, Nos. 19812 and 19970.....
19812	4421	Feed Lifting Rock Shaft Crank with 346E and 1861.....
346E	4453	Feed Lifting Rock Shaft Crank Clamping Screw.....
1861	862	Feed Lifting Rock Shaft Crank Roller and Stud.....
564c	898	Feed Lifting Rock Shaft Screw Center
58384	---	" " " " " "
		564c with 1508j.....
1508j	890	Feed Lifting Rock Shaft Screw Center Nut.....
19967	861	Feed Lifting Rock Shaft Wearing Block
2022	887	" " " " " "
		Position Pin.....
134E	900	Feed Lifting Rock Shaft Wearing Block Screw.....

NO.	PLATE	NAME
11375	830	Feed Regulator.....
568E	898	" " Hinge Screw.....
58322D	4489	" " Thumb Screw.....
58233	4490	" Rock Shaft.....
58234	---	Feed Rock Shaft complete, Nos. 58233 and 58235.....
58235	4491	Feed Rock Shaft Crank with 346E.....
346E	4453	" " " " Clamping Screw..
564c	898	" " " Screw Center.....
58384	---	" " " " " 564c with 1508j.....
1508j	890	Feed Rock Shaft Screw Center Nut.....
25881	894	Guide (6 in. face).....
254D	902	" Thumb Screw.....
11402	828	Lifting Presser Bar.....
19808	856	" " " Bell Crank.....
19809	---	" " " " 19808 with 611c and 19810.....
19810	856	Lifting Presser Bar Bell Crank Adjusting Link with 1518j, 1828 and 2718.....
1828	899	Lifting Presser Bar Bell Crank Adjusting Link Roller with 372c.....
372c	898	Lifting Presser Bar Bell Crank Adjusting Link Roller Screw.....
1518j	907	Lifting Presser Bar Bell Crank Adjusting Link Roller Screw Nut.....
2718	897	Lifting Presser Bar Bell Crank Adjusting Link Roller Screw Nut Washer.....
611c	905	Lifting Presser Bar Bell Crank Adjusting Link Screw.....
51260D	9619	Lifting Presser Bar Bell Crank Hinge Screw.....
51609E	9620	Lifting Presser Bar Bell Crank Hinge Screw Nut.....
58402	9627	Lifting Presser Bar Guide Bracket with 159E, 453c and 460c.....
159E	901	Lifting Presser Bar Guide Bracket Adjusting Screw.....
11405	830	Lifting Presser Bar Guide Bracket Guide
381E	899	" " " " " "
		Screw.....
453c	899	Lifting Presser Bar Guide Bracket Set Screw.....
11909	830	Lifting Presser Bar Lifter with 8761 and 8763.....

NO.	PLATE	NAME
8760	888	Lifting Presser Bar Lifter Friction Washer
16D	899	" " " " Hinge Screw...
8761	890	" " " " Stop Pin
11906	827	" " " " Lifting Link.....
524C	0619	" " " " " Cap Screw
8763	890	" " " " " H i n g e Stud.....
8973	862	Lifting Presser Bar Lifting Link Hinge Stud Pin.....
43267	4492	Lifting Presser Bar Lifting Link Hinge Stud Washer.....
258E	899	Lifting Presser Bar Screw Bushing.....
11409	827	" " " " Spring.....
11465	853	" " " " Bracket with 353c.....
353c	899	Lifting Presser Bar Spring Bracket Set Screw.....
11466	853	Lifting Presser Bar Spring Bracket Set Screw Washer.....
11380	828	Needle Bar.....
*11539	856	" " Connecting Link.....
566c	898	" " " " Hinge Screw
1513J	890	" " " " " Nut.....
11383	887	Needle Bar Connecting Stud with two 445F.....
19981	—	Needle Bar Connecting Stud 11383 with 11539.....
445F	900	Needle Bar Connecting Stud Set Screw...
258E	899	" " Screw Bushing.....
19702	890	" Clamp with 680F and 11385.....
*11385	890	" " Gib.....
680F	862	" " Thumb Screw.....
58253	—	Oil Cup.....
11917	825	" " Cover.....
9084	889	" " " Hinge Pin.....
2205	887	" " " Latch Spring.....
207F	901	" " " " " Screw.....
8953	874	" or Wax Stripper (felt).....
11918	888	" " " " Washer (steel) for 11917.....
8482	890	Oil or Wax Stripper Washer (steel) for 58253.....
207F	901	Oil or Wax Stripper Washer Screw.....
58254	4490	Oil Cup complete, Nos. 2205, 8482, 9084, 11917, 11918, 58253, two 8953 and three 207F.....

NO.	PLATE	NAME
134E	900	Oil Cup Screw.....
58573	9625	Oscillating Rock Shaft.....
58566	—	Oscillating Rock Shaft complete, Nos. 1508E, 11165, 51237c, 58570, 58573 and 58586.....
58585	9625	Oscillating Rock Shaft Hinge Pin.....
58586	—	" " " " " 58585 with 1508r.....
1508r	890	Oscillating Rock Shaft Hinge Pin Nut....
51237c	9619	" " " " " S c r e w Bearing.....
1508j	890	Oscillating Rock Shaft Hinge Pin Screw Bearing Nut.....
11165	897	Oscillating Rock Shaft Oil Pad.....
58567	—	" " " " T u b e w i t h 58569.....
58570	9616	Oscillating Rock Shaft Oil Tube complete, Nos. 58567, 58568 and 127848.....
58568	9616	Oscillating Rock Shaft Oil Tube Joint....
127848	9608	" " " " " Oil Cup
*58569	—	" " " " " Sleeve...
11850	825	" Shaft.....
11393	887	" " Collar with two 453c....
453c	899	" " " Set Screw.....
11848	—	" " Crank.....
19696	4421	Oscillating Shaft Crank complete, Nos. 453c, 1513j, 5868 and 11848.....
40025	4492	Oscillating Shaft Crank Pin.....
453c	899	" " " Set Screw.....
9119	4421	" " " Slide Block.....
5868	4421	Oscillating Shaft Crank Slide Block complete, Nos. 190E, 1054c, 5968 and 9119..
190E	899	Oscillating Shaft Crank Slide Block Cap Screw.....
5968	887	Oscillating Shaft Crank Slide Block Cap Screw Washer.....
1054c	4421	Oscillating Shaft Crank Slide Block Screw Stud.....
1513j	890	Oscillating Shaft Crank Slide Block Screw Stud Nut.....
252E	898	Pressure Regulating Thumb Screw.....
11910	7268	Shuttle Bobbin.....
19977	7268	" Cylinder.....
58213	—	" " 19977 with 773F and 19979.....
58527	9621	Shuttle Cylinder Hinge Pin.....
58979	9611	" " Latch.....

NO.	PLATE	NAME
12002	7268	Shuttle Cylinder Latch Pin.....
122419	9621	" " " Spring.....
58523	9612	" Frame.....
58524	—	" " 58523 with 12002, 58979 and 122419.....
773F	7268	Shuttle Tension Regulating Screw.....
19979	7268	" " Spring.....
58525	9613	Shuttle (cylinder) 3 in. diam., complete, Nos. 11910, 58213, 58524 and 58527....
11856	830	Shuttle Driver with 453c.....
2117	890	" " Pin.....
453c	899	" " Set Screw.....
11832	830	" Race Back.....
11833	889	" " " Position Pin.....
19577	864	" " " Spring.....
32D	901	" " " Screw.....
11835	—	" " Body.....
11836	825	Shuttle Race complete, Nos. 32D, 11832, 11835, 19577 and two 11833.....
134E	900	Shuttle Race Screw.....
11837	825	" " Frame with 11838.....
670E	862	" " " Clamping Screw.....
11838	889	" " " Position Pin.....
11418	858	" " Slide (left).....
11500	851	" " " (right).....
180D	901	" " " Screw.....
11421	887	Tension Bracket.....
190E	899	" " Screw.....
8879	887	" Friction Washer (cloth).....
11423	888	" " " (steel).....
1560c	903	" Regulating Thumb Nut.....
8905	887	" " " Washer..
411E	898	" Screw Stud.....
58589	—	" " " 411E with 1560c....
11422	888	" Spring.....
11044	897	" Wheel.....
11420	—	Tension (wheel) complete, Nos. 8905, 11044, 11422, 11423, 58589 and two 8879.....
11950	888	Thread Eyelet (side of arm).....
2102	888	" Retaining Disc.....
1560c	903	" " Regulating Thumb Nut
8905	887	" " " " " "
		Washer.....
686E	902	Thread Retaining Screw Stud.....
58590	—	" " " " 686E with 1560c.....

NO.	PLATE	NAME
2103	888	Thread Retaining Spring.....
11041	—	Thread Retainer complete, Nos. 2103, 8905, 58590 and two 2102.....
11428	827	Thread Take-up Cam with two 434c.....
8873	887	" " " Pin.....
434c	899	" " " Set Screw.....
58295	—	" " Lever.....
58296	4493	" " " 58295 with 1995...
58320	—	" " " 58296 with 50437D
50437D	4494	" " " Hinge Screw.....
1995	4452	" " " Roller and Screw Stud with 1518J.....
1518J	907	Thread Take-up Lever Roller and Screw Stud Nut.....
11052	887	Thread Take-up Spring.....
11431	888	" " " Regulator Plate
190E	899	" " " " " "
		Adjusting Screw.....
11432	—	Throat Plate Body for 11433 and 58241...
19873	—	" " " " 19875.....
11434	4416	" " Needle Plate (round needle hole) for 11433.....
11435	4416	Throat Plate Needle Plate (oblong needle hole) for 58241.....
19874	4424	Throat Plate Needle Plate (oblong needle hole) for 19875.....
219F	901	Throat Plate Needle Plate Screw.....
11433	4416	Throat Plate complete for 11369, Nos. 219F, 11432 and 11434.....
58241	—	Throat Plate complete for 11369, Nos. 219F, 11432 and 11435.....
19875	4424	Throat Plate complete for 19872, Nos. 19873, 19874 and three 219F.....
381D	899	Throat Plate Screw.....
*15404	—	Trade Mark.....
15405	4492	" " Rivet.....
14592	922	Vibrating Presser Bar.....
14593	4401	" " " Guide Bracket with 448c and 1192c.....
14594	—	Vibrating Presser Bar Guide Bracket complete, Nos. 231c, 11472, 14593, 14595 and two 190E.....
14595	4401	Vibrating Presser Bar Guide Bracket Cap
190E	899	" " " " " "
		Screw.....
1192c	9620	Vibrating Presser Bar Guide Bracket Posi- tion Screw.....

NO.	PLATE	NAME
448c	900	Vibrating Presser Bar Guide Bracket Set Screw.....
14596	862	Vibrating Presser Bar Hinge Pin.....
460c	4451	" " " " " " Set Screw
58556	9626	" " " " Spring.....
11472	853	" " " " Bracket....
231c	901	" " " " " " Screw
14597	4416	" " " " Foot.....
19792	4401	" " " " for open back book work (corrugated backs).....
898E	901	Vibrating Presser Foot Screw.....
1547J	903	" " " " " " Nut.....

MACHINE No. 7-6

FOR POWER TABLE

FOR UNDER DRIVER

This Machine is the same as No. 7-5
with the following exception:

NO.	PLATE	NAME
58411	9631	Balance Wheel with two 354c, in place of 11358.....

MACHINE No. 7-7

FOR POWER TABLE. HAS S. D. A.

This Machine is the same as No. 7-5
with the following exceptions:

NO.	PLATE	NAME
58329	4495	Arm Shaft, in place of 11353.....
949E	4494	" " " " Screw.....
9842	4492	" " " " Washer.....
122301	—	Balance Wheel with two 354c.....
122302	4496	" " " " 122301 with 11442, 122469, two 1402E and four 401E, in place of 11358.....
25362	9621	Balance Wheel Ball, size $\frac{3}{8}$ in.....
122303	—	" " " " Ring.....
122304	4493	" " " " " " 122303 with eighteen 25362.....

NO.	PLATE	NAME
122306	4493	Balance Wheel Ball Washer (left).....
122469	9616	" " " " " " (right).....
1402E	4494	" " " " " " Screw
11442	896	" " " " Friction Washer (paper)..
401E	899	" " " " " " Screw....

MACHINE No. 7-8

HAS BELT SHIFTER FOR FLAT BELT

This Machine is the same as No. 7-5
with the following exceptions:

NO.	PLATE	NAME
11878	838	Arm Shaft, in place of 11353.....
58407	9631	Balance Wheel and Pulley (tight) with two 354c, in place of 11358.....

Genuine Singer Needles should be used
in Singer Machines.
These Needles and their Containers
are marked with the
Company's Trade Mark "SIMANCO." 1

Needles in Containers marked
"For Singer Machines"
are not Singer made needles. 2

LIST OF PARTS COMPLETE

FOR

MACHINE No. 7-10

FOR EITHER CLOTH OR LEATHER, ESPECIALLY LIGHT HARNESS, AS ORDERED. DROP FEED. THE PRESSER FOOT IS QUICKLY ADJUSTABLE FROM VIBRATING TO STATIONARY AND VICE VERSA. PARTS AND ATTACHMENTS CAN BE FURNISHED AT AN ADDITIONAL CHARGE FOR BINDING, FOLDING AND OTHER OPERATIONS IN SADDLERY, HARNESS, ETC. STITCH $\frac{3}{8}$ IN. TO $\frac{7}{8}$ IN. LONG.

NO.	PLATE	NAME
*58250	---	Arm with 11559, 11560, 15404 and two each 128E, 612E and 15405.....
8702	887	Arm Dowel Pin.....
127848	9608	" Oil Cup, for oiling Arm Shaft Front and Back Bearings.....
58565	9608	Arm Oil Tube, for oiling Arm Shaft Intermediate Bearing.....
50348E	9619	Arm Screw.....
11912	915	" Shaft.....
11354	830	" " Bushing.....
437c	899	" " " Set Screw.....
11913	825	" Side Cover.....
65D	899	" " " Hinge Screw.....
11517	854	Balance Wheel (two speed) with 347c....
11518	859	" " Key.....
347c	900	" " Set Screw.....
*11359	---	Bed.....
24131	9608	" Oil Tube with 52045, for oiling Feed Rock Shaft (back) Bearing.....
58549	9608	Bed Oil Tube with 52045, for oiling Feed Lifting and Feed Rock Shaft (front) Bearings.....
52045	9608	Bed Oil Tube Packing (felt).....
11363	825	Crank Connecting Rod.....
565c	898	" " " Hinge Screw.....
1513J	890	" " " " " Nut
58214	4495	Face Plate.....

NO.	PLATE	NAME
58215	---	Face Plate complete, Nos. 190E, 910C, 11867, 11871, 11872, 11875, 11876, 19866, 41544, 58214, 58522, 58581 or 58582 and two 164E.....
11872	861	Face Plate Thread Eyelet.....
58522	9608	" " " Guard.....
190E	899	" " " " Screw.....
161E	901	" " Screw.....
11365	828	Feed Bar.....
307c	898	" " Screw Center.....
56814	---	" " " " 307c with 1513J..
1513J	890	" " " " Nut.....
11367	830	" Cam with two 445c.....
445c	900	" " Set Screw.....
11368	830	" Connecting Link.....
565c	898	" " " Hinge Screw.....
1513J	890	" " " " " Nut..
19524	875	" Dog, 14 teeth (10 teeth to the inch) for general work, for 11433 and 58241..
11521	4425	Feed Dog, 8 teeth (10 teeth to the inch) for bag handles, for 11556.....
166E	899	Feed Dog Screw.....
11370	825	" Forked Connection.....
565c	898	" " " Hinge Screw....
1513J	890	" " " " " Nut
19970	4420	" Lifting Rock Shaft with 134E, 2022 and 19967.....
19971	---	Feed Lifting Rock Shaft complete, Nos. 19812 and 19970.....
19812	4421	Feed Lifting Rock Shaft Crank with 346E and 1861.....
346E	4453	Feed Lifting Rock Shaft Crank Clamping Screw.....
1861	862	Feed Lifting Rock Shaft Crank Roller and Stud.....
564c	898	Feed Lifting Rock Shaft Screw Center
58384	---	" " " " " " "
1508J	890	564c with 1508J.....
19967	861	Feed Lifting Rock Shaft Screw Center Nut.....
2022	887	Feed Lifting Rock Shaft Wearing Block " " " " " "
134E	900	Position Pin.....
11375	830	Feed Lifting Rock Shaft Wearing Block Screw.....
568E	898	Feed Regulator.....
568E	898	" " Hinge Screw.....

NO.	PLATE	NAME
50322D	4489	Feed Regulator Thumb Screw.....
58232	4491	“ “ “ “ Stop.....
58233	4490	“ “ “ “ Rock Shaft.....
58234	—	Feed Rock Shaft complete, Nos. 58233 and 58235.....
58235	4491	Feed Rock Shaft Crank with 346E.....
346E	4453	“ “ “ “ Clamping Screw..
564c	898	“ “ “ “ Screw Center.....
58384	—	“ “ “ “ “ 564c with 1508J.....
1508J	890	Feed Rock Shaft Screw Center Nut.....
25881	894	Guide (6 in. face).....
19658	909	“ for stitching round eye flaps, for 19659.....
164D	4415	Guide Screw for 19658.....
41544	4415	“ “ Washer.....
254D	902	“ Thumb Screw for 25881.....
58236	4493	Lifting Presser Bar.....
11523	856	“ “ “ “ Bell Crank.....
11524	—	“ “ “ “ “ Adjusting Link.....
11525	856	Lifting Presser Bar Bell Crank Adjusting Link complete, Nos. 1518J, 1828, 2718 and 11524.....
1828	899	Lifting Presser Bar Bell Crank Adjusting Link Roller with 372c.....
372c	898	Lifting Presser Bar Bell Crank Adjusting Link Roller Screw.....
1518J	907	Lifting Presser Bar Bell Crank Adjusting Link Roller Screw Nut.....
2718	897	Lifting Presser Bar Bell Crank Adjusting Link Roller Screw Nut Washer.....
611c	905	Lifting Presser Bar Bell Crank Adjusting Link Screw.....
11526	889	Lifting Presser Bar Bell Crank Connecting Stud with two 858c.....
11527	—	Lifting Presser Bar Bell Crank Connecting Stud complete, Nos. 164E, 11526 and 11528.....
164E	899	Lifting Presser Bar Bell Crank Connecting Stud Cap Screw.....
11528	862	Lifting Presser Bar Bell Crank Connecting Stud Cap Screw Washer.....
858c	900	Lifting Presser Bar Bell Crank Connecting Stud Set Screw.....
51260D	9619	Lifting Presser Bar Bell Crank Hinge Screw.....

NO.	PLATE	NAME
51609E	9620	Lifting Presser Bar Bell Crank Hinge Screw Nut.....
11859	4433	Lifting Presser Bar Bell Crank Lifting Cam.....
2022	887	Lifting Presser Bar Bell Crank Lifting Cam Pin.....
159E	901	Lifting Presser Bar Bell Crank Lifting Cam Screw.....
11867	857	Lifting Presser Bar Lifter.....
58237	4491	“ “ “ “ Bracket with 1497F and 58238.....
1497F	4491	Lifting Presser Bar Lifter Bracket Set Screw.....
58238	4491	Lifting Presser Bar Lifter Bracket Spring Bearing.....
19866	862	Lifting Presser Bar Lifter Hinge Pin
910c	900	“ “ “ “ “ “ Set Screw.....
58270	4491	Lifting Presser Bar Guide with 453c and 896E.....
896E	4491	Lifting Presser Bar Guide Adjusting Screw.....
453c	899	Lifting Presser Bar Guide Set Screw.....
11409	827	“ “ “ “ Spring (spiral).....
11031	863	“ “ “ “ (flat).....
58252	4493	“ “ “ “ Bracket.....
1177E	4494	“ “ “ “ “ Screw.
11661	9608	“ “ “ “ Guide Pin.....
50323D	4489	“ “ “ “ Regulating Thumb Screw.....
11538	855	Needle Bar.....
*11539	856	“ “ Connecting Link.....
566c	898	“ “ “ “ Hinge Screw
1513J	890	“ “ “ “ “ “ Nut.....
58242	4491	Needle Bar Connecting Stud with two 129E.....
58246	—	Needle Bar Connecting Stud 58242 with 11539.....
129E	901	Needle Bar Connecting Stud Clamping Screw.....
258E	899	Needle Bar Screw Bushing.....
19702	890	“ Clamp with 680F and 11385.....
*11385	890	“ “ Gib.....
680F	862	“ “ Thumb Screw.....
58253	—	Oil Cup.....
11917	825	“ “ Cover.....

NO.	PLATE	NAME
9084	889	Oil Cup Cover Hinge Pin.....
2205	887	" " " Latch Spring.....
207F	901	" " " " " Screw.....
8953	874	" or Wax Stripper (felt).....
11918	888	" " " " Washer (steel) for 11917.....
8482	890	Oil or Wax Stripper Washer (steel) for 58253.....
207F	901	Oil or Wax Stripper Washer Screw.....
58254	4490	Oil Cup complete, Nos. 2205, 8482, 9084, 11917, 11918, 58253, two 8953 and three 207F.....
11544	854	Oil Cup Lamp Holder.....
190E	899	" " " " Screw.....
134E	900	" " Screw.....
58573	9625	Oscillating Rock Shaft.....
58566	—	Oscillating Rock Shaft complete, Nos. 1508J, 11165, 51237c, 58570, 58573 and 58586.....
58585	9625	Oscillating Rock Shaft Hinge Pin.....
58586	—	" " " " " 5 8 5 8 5 with 1508J.....
1508J	890	Oscillating Rock Shaft Hinge Pin Nut....
51237c	9619	" " " " " Screw Bearing.....
1508J	890	Oscillating Rock Shaft Hinge Pin Screw Bearing Nut.....
11165	897	Oscillating Rock Shaft Oil Pad.....
58567	—	" " " " Tube with 58569.....
58570	9616	Oscillating Rock Shaft Oil Tube complete, Nos. 58567, 58568 and 127848.....
58568	9616	Oscillating Rock Shaft Oil Tube Joint....
127848	9608	" " " " " Oil Cup..
*58569	—	" " " " " Sleeve....
11850	825	" Shaft.....
11393	887	" " Collar with two 453c....
453c	899	" " " Set Screw.....
11848	—	" " Crank.....
19696	4421	Oscillating Shaft Crank complete, Nos. 453c, 1513J, 5868 and 11848.....
40025	4492	Oscillating Shaft Crank Pin.....
453c	899	" " " Set Screw.....
9119	4421	" " " Slide Block.....
5868	4421	Oscillating Shaft Crank Slide Block com- plete, Nos.190E, 1054c, 5968 and 9119..

NO.	PLATE	NAME
190E	899	Oscillating Shaft Crank Slide Block Cap Screw.....
5968	887	Oscillating Shaft Crank Slide Block Cap Screw Washer.....
1054c	4421	Oscillating Shaft Crank Slide Block Screw Stud.....
1513J	890	Oscillating Shaft Crank Slide Block Screw Stud Nut.....
11910	7268	Shuttle Bobbin.....
19977	7268	" Cylinder.....
58213	—	" " 19977 with 773F and 19979.....
58527	9621	Shuttle Cylinder Hinge Pin.....
58979	9611	" " Latch.....
12002	7268	" " " Pin.....
122419	9621	" " " Spring.....
58523	9612	" Frame.....
58524	—	" " 58523 with 12002, 58979 and 122419.....
773F	7268	Shuttle Tension Regulating Screw.....
19979	7268	" " Spring.....
58525	9613	Shuttle (cylinder) 3 in. diam., complete, Nos. 11910, 58213, 58524 and 58527....
11856	830	Shuttle Driver with 453c.....
2117	890	" " Pin.....
453c	899	" " Set Screw.....
11832	830	" Race Back.....
11833	889	" " " Position Pin.....
19577	864	" " " Spring.....
32D	901	" " " " Screw.....
11835	—	" " Body.....
11836	825	Shuttle Race complete, Nos. 32D, 11832, 11835, 19577 and two 11833.....
134E	900	Shuttle Race Screw.....
11837	825	" " Frame with 11838.....
670E	862	" " " Clamping Screw.....
11838	889	" " " Position Pin.....
11418	858	" " Slide (left).....
19657	908	" " " (right).....
180D	901	" " " " Screw.....
58255	4493	Spool Holder Bracket.....
58256	4493	Spool Holder Bracket complete, Nos. 11881 and 58255.....
129E	901	Spool Holder Bracket Screw.....
851E	857	" " Tension Spool Pin with fixed cone.....

NO.	PLATE	NAME
8019	887	Spool Holder Tension Spool Pin Spring . .
8018	887	" " " " " Conc. . . .
1541E	890	" " " " " Nut. . . .
11881	857	Spool Holder Tension Spool Pin complete, Nos. 851E, 1541E, 8018 and 8019. . . .
8879	887	Tension Friction Washer (cloth). . . .
11043	897	" " " (steel). . . .
1560c	903	" Regulating Thumb Nut. . . .
8905	887	" " " " Washer. . . .
850E	902	" Screw Stud. . . .
58591	—	" " " 850E with 1560c. . . .
8791	888	" Spring. . . .
11044	897	" Wheel. . . .
11871	—	Tension (wheel) complete, Nos. 8791, 8905, 11043, 11044, 58591 and two 8879. . . .
11547	859	Thread Retaining Bracket. . . .
158E	901	" " " Screw. . . .
2102	888	" " Disc. . . .
1560c	903	" " Regulating Thumb Nut
8905	887	" " " " " Washer. . . .
633E	862	Thread Retaining Screw Stud. . . .
58592	—	" " " 633E with 1560c. . . .
2103	888	Thread Retaining Spring. . . .
2049	853	" " Thread Guide Pin. . . .
11546	—	Thread Retainer complete, Nos. 2049, 2103, 8905, 11547, 58592 and two 2102. . . .
11857	—	Thread Take-up Cam with two 434c. . . .
8873	887	" " " Pin. . . .
434c	899	" " " Set Screw. . . .
11858	910	Thread Take-up Cam complete, Nos. 2022, 11857, 11859 and two 159E. . . .
58297	—	Thread Take-up Lever. . . .
58298	4493	" " " 58297 with 1948 and 1995. . . .
58314	—	Thread Take-up Lever 58298 with 50437D
50437D	4494	" " " Hinge Screw. . . .
1995	4452	" " " Roller and Screw Stud with 1518J. . . .
1518J	907	Thread Take-up Lever Roller and Screw Stud Nut. . . .
1948	4452	Thread Take-up Lever Thread Guiding Roller and Screw Stud. . . .
58581	9626	Thread Take-up Spring (.083 in. wire) for general work. . . .

NO.	PLATE	NAME
58582	9626	Thread Take-up Spring (.095 in. wire) for extra heavy work. . . .
11875	857	Thread Take-up Spring Regulator. . . .
164E	899	" " " " Screw. . . .
164E	899	" " " " Screw. . . .
41544	4415	" " " " Washer. . . .
11876	860	" " " Thread Guard. . . .
11432	—	Throat Plate Body for 11433 and 58241. . . .
11434	4416	" " Needle Plate (round needle hole) for 11433. . . .
11435	4416	Throat Plate Needle Plate (oblong needle hole) for 58241. . . .
219F	901	Throat Plate Needle Plate Screw. . . .
11433	4416	Throat Plate complete for 19524, Nos. 219F, 11432 and 11434. . . .
58241	—	Throat Plate complete for 19524, Nos. 219F, 11432 and 11435. . . .
11555	—	Throat Plate Body for 11556. . . .
11557	4425	" " Needle Hole Strip (round needle hole) for 11556. . . .
202F	900	Throat Plate Needle Hole Strip Screw. . . .
11556	4425	Throat Plate complete for 11521, Nos. 11555, 11557 and two 202F. . . .
381D	899	Throat Plate Screw. . . .
*15404	—	Trade Mark. . . .
15405	4492	" " Rivet. . . .
11558	848	Vibrating Presser Bar. . . .
11560	4433	" " " Cap Bracket (lower). . . .
11559	4433	Vibrating Presser Bar Cap Bracket (upper). . . .
612E	901	Vibrating Presser Bar Cap Bracket Screw (long). . . .
128E	901	Vibrating Presser Bar Cap Bracket Screw (short). . . .
58239	4491	Vibrating Presser Bar Guide Bracket with 874E and 1497F. . . .
1497F	4491	Vibrating Presser Bar Guide Bracket Screw. . . .
681D	862	Vibrating Presser Bar Hinge Screw. . . .
11563	862	" " " Spring Stud with 19877. . . .
19877	890	Vibrating Presser Bar Spring Stud Pin. . . .
190E	899	" " " " " Screw. . . .
11564	862	" " " " " Spring
58240	4491	" " " " Stop Block. . . .

NO.	PLATE	NAME
082d	862	Vibrating Presser Bar Stop Block Thumb Screw.....
6312	862	Vibrating Presser Bar Stop Block Thumb Screw Washer.....
874E	4491	Vibrating Presser Bar Stop Block Stop Screw.....
11568	4426	Vibrating Presser Foot (narrow).....
11569	4426	“ “ “ (wide).....
19659	909	“ “ “ for blinds and stitching around eye flaps.....
19660	909	Vibrating Presser Foot, for stitching bag and trunk handles.....
19661	909	Vibrating Presser Foot, for stitching over rounded traces of any width.....
164E	899	Vibrating Presser Foot Screw.....

Genuine Singer Needles should be used in Singer Machines. These Needles and their Containers are marked with the Company's Trade Mark "SIMANCO." 1

Needles in Containers marked "For Singer Machines" are not Singer made needles. 2

LIST OF PARTS COMPLETE
FOR

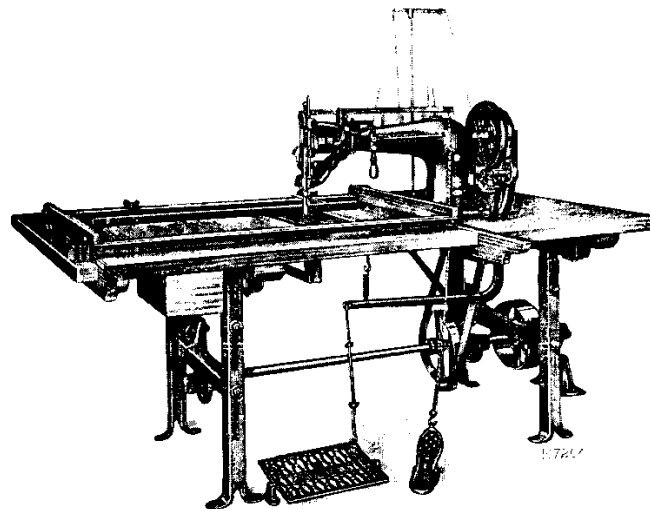

MACHINE No. 7-11 ON TABLE No. 5280 AND STEEL WORK No. 126619
(FOR DESCRIPTION OF TABLE AND STEEL WORK SEE FORM 8801)

MACHINE No. 7-11

FOR BOOKBINDING. FOR STITCHING EACH SECTION OR SIGNATURE TO A PREPARED STRIP, EITHER SINGLE OR CONTINUOUS, MAKING A FIRMLY FASTENED AND FLAT OPENING BOOK. DROP FEED. THE MACHINE HAS REVERSIBLE FEED, STRIP GUIDES FOR STYLE OF STRIP TO BE USED, AND MAKES STITCH 1/4 IN. TO 1 IN. LONG. THE STITCHING IS COMMENCED A SHORT DISTANCE BELOW THE UPPER END OF THE SECTION AND THE WORK MOVES BACKWARD; WHEN THE UPPER END IS REACHED THE FEED IS REVERSED; THE NEEDLE ENTERS THE HOLES BEFORE MADE AND THE SECTION IS STITCHED DOWN TO THE LOWER END. THE FEED IS THEN AGAIN REVERSED AND THE STITCHING FINISHED A SHORT DISTANCE ABOVE THE LOWER END. HAS S. D. A.

NO.	PLATE	NAME
*11584	—	Arm with 15404 and two 15405.....

NO.	PLATE	NAME
8702	887	Arm Dowel Pin.....
127848	9608	" Oil Cup, for oiling Arm Shaft Front and Back Bearings.....
58564	9608	Arm Oil Tube, for oiling Arm Shaft Intermediate Bearing.....
50348E	9619	Arm Screw.....
58330	4495	" Shaft.....
11354	830	" " Bushing.....
437c	899	" " " Set Screw.....
949E	4494	" " " Screw.....
9842	4492	" " " Washer.....
11913	825	" Side Cover.....
65D	899	" " " Hinge Screw.....
8708	827	" Spool Pin.....
11241	858	" " " Washer (cloth).....
122301	—	Balance Wheel with two 354c.....
122302	4496	" " 122301 with 11442, 122469, two 1402E and four 401E.....
25362	9621	Balance Wheel Ball, size $\frac{1}{8}$ in.....
122303	—	" " " Ring.....
122304	4493	" " " " 122303 with eighteen 25362.....
122306	4493	Balance Wheel Ball Washer (left).....
122469	9616	" " " " (right).....
1402E	4494	" " " " " Screw.....
11442	896	" " Friction Washer (paper).....
401E	899	" " " " " Screw....
354c	899	" " Set Screw.....
*11359	—	Bed.....
24131	9608	" Oil Tube with 52045, for oiling Feed Rock Shaft (back) Bearing.....
58549	9608	Bed Oil Tube with 52045, for oiling Feed Lifting and Feed Rock Shaft (front) Bearings.....
52045	9608	Bed Oil Tube Packing (felt).....
11680	840	Cloth Plate.....
389F	901	" " Screw.....
11363	825	Crank Connecting Rod.....
565c	898	" " " Hinge Screw.....
1513J	890	" " " " " Nut.....
19503	841	Feed Bar.....
307c	898	" " Screw Center.....
56814	—	" " " " 307c with 1513J..
1513J	890	" " " " " Nut.....
11589	—	" Cam.....
11590	843	Feed Cam complete, Nos. 155E, 161E, 761c, 11589 and 11591.....

NO.	PLATE	NAME
11591	843	Feed Cam Clutch.....
155E	901	" " " Screw.....
761c	900	" " Position Screw.....
11368	830	" Connecting Link.....
565c	898	" " " Hinge Screw.....
1513J	890	" " " " " Nut..
19791	924	" Dog, 17 teeth (11 teeth to the inch) for 19740 and 19743.....
166E	899	Feed Dog Screw.....
11593	838	" Forked Connection.....
19504	847	" " " Friction Spring
869E	901	" " " " " " Screw.....
1520J	905	Feed Forked Connection Friction Spring Screw Nut.....
565c	898	Feed Forked Connection Hinge Screw....
1513J	890	" " " " " " Nut
19968	4420	" Lifting Rock Shaft with 134E, 2022 and 19967.....
19969	—	Feed Lifting Rock Shaft complete, Nos. 19814 and 19968.....
19814	4421	Feed Lifting Rock Shaft Crank with 346E, 1518J and 1866.....
346E	4453	Feed Lifting Rock Shaft Crank Clamping Screw.....
1866	900	Feed Lifting Rock Shaft Crank Roller with 372c.....
372c	898	Feed Lifting Rock Shaft Crank Roller Screw.....
1518J	907	Feed Lifting Rock Shaft Crank Roller Screw Nut.....
564c	898	Feed Lifting Rock Shaft Screw Center....
58384	—	" " " " " " " 564c with 1508J.....
1508J	890	Feed Lifting Rock Shaft Screw Center Nut.....
19967	861	Feed Lifting Rock Shaft Wearing Block
2022	887	" " " " " " " " Position Pin.....
134E	900	Feed Lifting Rock Shaft Wearing Block Screw.....
11375	830	Feed Regulator.....
568E	898	" " Hinge Screw.....
50322D	4489	" " Thumb Screw.....
11915	841	" Reverse Lever.....
19505	841	Feed Reverse Lever complete, Nos. 3146, 11915 and 19507.....

NO.	PLATE	NAME
19506	861	Feed Reverse Lever Bracket.....
129E	901	" " " " Screw....
11914	839	" " " " Connection.....
58D	899	" " " " Hinge Screw (lever end).....
65D	899	Feed Reverse Lever Connection Hinge Screw (switch clutch end).....
19507	841	Feed Reverse Lever Handle.....
3146	4415	" " " " Washer.....
58D	899	" " " " Hinge Screw.....
41544	4415	" " " " Stop Washer.....
161E	901	" " " " Screw..
11846	839	" " Stop Lever with 1518j and 1892.....
19508	841	Feed Reverse Stop Lever Bracket.....
134E	900	" " " " " Screw..
19509	890	" " " " Cushion (raw- hide).....
233E	901	Feed Reverse Stop Lever Cushion Screw..
567D	898	" " " " Hinge Screw....
1892	900	" " " " Roller and Screw Stud.....
1518J	907	Feed Reverse Stop Lever Roller and Screw Stud Nut.....
19510	886	Feed Reverse Stop Lever Spring.....
11446	890	" " " " " Hook....
82D	905	" " " " " Screw...
11598	838	" Rock Shaft.....
11599	—	Feed Rock Shaft complete, Nos. 11598 and 58447.....
58447	9027	Feed Rock Shaft Crank with 50124E.....
8873	887	" " " " Pin.....
50124E	4494	" " " " Set Screw.....
564c	898	" " " " Screw Center.....
58384	—	" " " " " 564c with 1508J.....
1508J	890	Feed Rock Shaft Screw Center Nut.....
26159	894	Guide (10 in. face).....
120690	9626	" with Ridge.....
401D	899	" Screw for 120690.....
254D	902	" Thumb Screw for 26159.....
11402	828	Lifting Presser Bar.....
19512	842	" " " 11402 with 2049 and 19517.....
11463	851	Lifting Presser Bar Guide Bracket with 159E and 453c.....

NO.	PLATE	NAME
159E	901	Lifting Presser Bar Guide Bracket Adjust- ing Screw.....
11405	830	Lifting Presser Bar Guide Bracket Guide
381E	899	" " " " " " Screw.....
453c	899	Lifting Presser Bar Guide Bracket Set Screw.....
11909	830	Lifting Presser Bar Lifter with 8761 and 8763.....
8760	888	Lifting Presser Bar Lifter Friction Washer
16D	899	" " " " Hinge Screw...
8761	890	" " " " Stop Pin.....
11906	827	" " " Lifting Link.....
524c	9619	" " " " " Cap Screw
8763	890	" " " " " Hinge Stud
8973	862	" " " " " " "
43267	4492	Pin..... Lifting Presser Bar Lifting Link Hinge Stud Washer.....
258E	899	Lifting Presser Bar Screw Bushing.....
11409	827	" " " Spring.....
11411	887	" " " " Collar with 453c.....
453c	899	Lifting Presser Bar Spring Collar Set Screw.....
11380	828	Needle Bar.....
*11539	856	" " Connecting Link.....
566c	898	" " " " Hinge Screw
1513J	890	" " " " " " " Nut.....
11383	887	Needle Bar Connecting Stud with two 445F.....
19981	—	Needle Bar Connecting Stud 11383 with 11539.....
445F	900	Needle Bar Connecting Stud Set Screw...
258E	899	" " Screw Bushing.....
19702	890	" Clamp with 680F and 11385.....
*11385	890	" " Gib.....
680F	862	" " Thumb Screw.....
58253	—	Oil Cup.....
11917	825	" " Cover.....
9084	889	" " " Hinge Pin.....
2205	887	" " " Latch Spring.....
207F	901	" " " " " Screw.....
8953	874	" or Wax Stripper (felt).....
11918	888	" " " " Washer (steel) for 11917.....

NO.	PLATE	NAME
8482	890	Oil or Wax Stripper Washer (steel) for 58253.....
207F	901	Oil or Wax Stripper Washer Screw.....
58254	4490	Oil Cup complete, Nos. 2205, 8482, 9084, 11917, 11918, 58253, two 8953 and three 207F.....
134E	900	Oil Cup Screw.....
58573	9625	Oscillating Rock Shaft.....
58566	—	Oscillating Rock Shaft complete, Nos. 1508J, 11165, 51237c, 58570, 58573 and 58586.....
58585	9625	Oscillating Rock Shaft Hinge Pin.....
58586	—	" " " " " 58585 with 1508J.....
1508J	890	Oscillating Rock Shaft Hinge Pin Nut....
51237c	9619	" " " " " Screw Bearing.....
1508J	890	Oscillating Rock Shaft Hinge Pin Screw Bearing Nut.....
11165	897	Oscillating Rock Shaft Oil Pad.....
58567	—	" " " " Tube with 58569.....
58570	9616	Oscillating Rock Shaft Oil Tube complete, Nos. 58567, 58568 and 127848.....
58568	9616	Oscillating Rock Shaft Oil Tube Joint....
127848	9608	" " " " " Oil Cup..
*58569	—	" " " " " Sleeve...
11850	825	" Shaft.....
11393	887	" " Collar with two 453c....
453c	899	" " " Set Screw.....
11848	—	" " Crank.....
19696	4421	Oscillating Shaft Crank complete, Nos. 453c, 1513J, 5868 and 11848.....
40025	4492	Oscillating Shaft Crank Pin.....
453c	899	" " " Set Screw.....
9119	4421	" " " Slide Block.....
5868	4421	Oscillating Shaft Crank Slide Block complete, Nos. 190E, 1054c, 5968 and 9119.....
190E	899	Oscillating Shaft Crank Slide Block Cap Screw.....
5968	887	Oscillating Shaft Crank Slide Block Cap Screw Washer.....
1054c	4421	Oscillating Shaft Crank Slide Block Screw Stud.....
1513J	890	Oscillating Shaft Crank Slide Block Screw Stud Nut.....

NO.	PLATE	NAME
11949	839	Presser Bar.....
11634	886	" " Guide Bracket with 446c and 1192c.....
11635	—	Presser Bar Guide Bracket complete, Nos. 11470, 11634 and two 190E.....
11470	851	Presser Bar Guide Bracket Cap.....
190E	899	" " " " " Screw
1192c	9620	" " " " " Position Screw.....
446c	899	Presser Bar Guide Bracket Set Screw....
164E	899	" " Hinge Cap Screw.....
41544	4415	" " " " " Washer....
19737	924	" Foot.....
704E	9620	" " Screw.....
1700J	9620	" " " Nut.....
252E	898	Pressure Regulating Thumb Screw.....
11910	7268	Shuttle Bobbin.....
19977	7268	" Cylinder.....
58213	—	" " 19977 with 773F and 19979.....
58527	9621	Shuttle Cylinder Hinge Pin.....
58979	9611	" " Latch.....
12002	7268	" " " Pin.....
122419	9621	" " " Spring.....
58523	9612	" Frame.....
58524	—	" " 58523 with 12002, 58979 and 122419.....
773F	7268	Shuttle Tension Regulating Screw.....
19979	7268	" " Spring.....
58525	9613	Shuttle (cylinder) 3 in. diam., complete, Nos. 11910, 58213, 58524 and 58527....
11856	830	Shuttle Driver with 453c.....
2117	890	" " Pin.....
453c	899	" " Set Screw.....
11832	830	" Race Back.....
11833	889	" " " Position Pin.....
19577	864	" " " Spring.....
32D	901	" " " Screw.....
11835	—	" " Body.....
11836	825	Shuttle Race complete, Nos. 32D, 11832, 11835, 19577 and two 11833.....
134E	900	Shuttle Race Screw.....
11837	825	" " Frame with 11838.....
670E	862	" " " Clamping Screw....
11838	889	" " " Position Pin.....

NO.	PLATE	NAME
11627	843	Strip Guide (left).....
11626	843	" " (right).....
96D	901	" " Screw.....
11607	843	Switch Clutch.....
11608	9616	" " Driver.....
159E	901	" " " Screw.....
161E	901	" " Driving Screw.....
11610	843	" " Lever with 1813.....
11611	9617	" " " Bracket.....
145E	899	" " " " Screw.....
65D	899	" " " Hinge Screw.....
1813	899	" " " Roller and Stud.....
11612	9621	" " Key.....
11421	887	Tension Bracket.....
190E	899	" " " Screw.....
8879	887	" Friction Washer (cloth).....
11423	888	" " " (steel).....
1560c	903	" Regulating Thumb Nut.....
8905	887	" " " Washer.....
411E	898	" Screw Stud.....
58589	—	" " " 411E with 1560c.....
11422	888	" Spring.....
11044	897	" Wheel.....
11420	—	Tension (wheel) complete, Nos. 8905, 11044, 11422, 11423, 58589 and two 8879.....
11950	888	Thread Eyelet (side of arm).....
2102	888	" Retaining Disc.....
1560c	903	" " Regulating Thumb Nut.....
8905	887	" " " " " " Washer.....
686E	902	Thread Retaining Screw Stud.....
58590	—	" " " " 686E with 1560c.....
2103	888	Thread Retaining Spring.....
11041	—	Thread Retainer complete, Nos. 2103, 8905, 58590 and two 2102.....
19513	842	Thread Take-up Cam with two 434c.....
8873	887	" " " Pin.....
434c	899	" " " Set Screw.....
58295	—	" " " Lever.....
58296	4493	" " " 58295 with 1995... ..
58320	—	" " " 58296 with 50437D.....
50437D	4494	" " " Hinge Screw.....
1995	4452	" " " Roller and Screw Stud with 1518J.....

NO.	PLATE	NAME
1518J	907	Thread Take-up Lever Roller and Screw Stud Nut.....
11052	887	Thread Take-up Spring.....
11431	888	" " " Regulator Plate.....
190E	899	" " " " " " Adjusting Screw.....
19738	—	Throat Plate Body for 19740.....
19739	924	" " Needle Hole Strip.....
401D	899	" " " " " Screw....
19740	924	Throat Plate complete for 19791, Nos. 19738, 19739 and two 401D.....
19741	—	Throat Plate Body for 19743.....
19742	925	" " Needle Hole Strip with ridge.....
401D	899	Throat Plate Needle Hole Strip Screw....
19743	925	Throat Plate complete for 19791, Nos. 19741, 19742 and two 401D.....
381D	899	Throat Plate Screw.....
*15404	—	Trade Mark.....
15405	4492	" " Rivet.....

Genuine Singer Needles should be used
in Singer Machines.
These Needles and their Containers
are marked with the
Company's Trade Mark "SIMANCO." 1

Needles in Containers marked
"For Singer Machines"
are not Singer made needles. 2

**LIST OF PARTS COMPLETE
FOR**

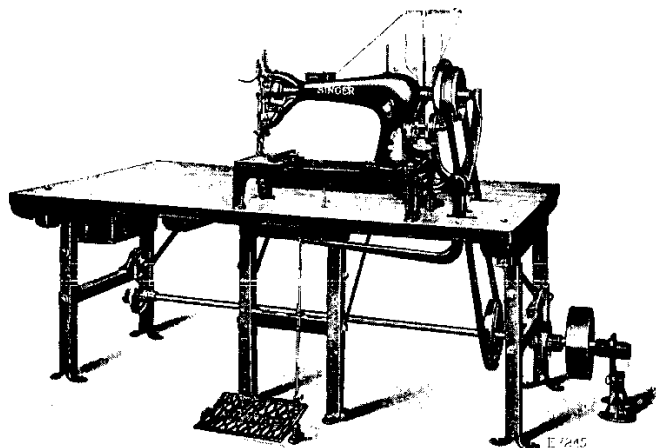

MACHINE No. 7-13 ON TABLE 5292 AND STEEL WORK
No. 126623

(FOR DESCRIPTION OF TABLE AND STEEL WORK
SEE FORM 8801)

MACHINE No. 7-13

FOR STITCHING PAMPHLETS AS THICK AS THE NEEDLE WILL
PENETRATE OR ABOUT $\frac{3}{8}$ INCH IN SOFT PAPER. LIFT
OF PRESSER FOOT $\frac{1}{16}$ INCH. MAKES STITCH FROM $\frac{5}{16}$ IN.
TO 1 IN. LONG. HAS DROP FEED, VIBRATING PRESSER
AND S. D. A.

NO.	PLATE	NAME
*19959	—	Arm with 15404 and two 15405.....
8702	887	" Dowel Pin.....
127848	9608	" Oil Cup, for oiling Arm Shaft Front and Back Bearings.....
58564	9608	Arm Oil Tube, for oiling Arm Shaft Inter- mediate Bearing.....

NO.	PLATE	NAME
50348E	9619	Arm Screw.....
58329	4495	" Shaft.....
11354	830	" " Bushing.....
437C	899	" " " Set Screw.....
949E	4494	" " Screw.....
9842	4492	" " " Washer.....
11913	825	" Side Cover.....
65D	899	" " " Hinge Screw.....
8708	827	" Spool Pin.....
11241	858	" " " Washer (cloth).....
122301	—	Balance Wheel with two 354c.....
122302	4496	" " 122301 with 11442, 122469 two 1402E and four 401E.....
25362	9621	Balance Wheel Ball, size $\frac{1}{8}$ in.....
122303	—	" " " Ring.....
122304	4493	" " " " 122303 with eighteen 25362.....
122306	4493	Balance Wheel Ball Washer (left).....
122469	9616	" " " " (right).....
1402E	4494	" " " " " Screw
11442	896	" " Friction Washer (paper)..
401E	899	" " " " Screw...
354c	899	" " Set Screw.....
*11359	—	Bed.....
24131	9608	" Oil Tube with 52045, for oiling Feed Rock Shaft (back) Bearing.....
58549	9608	Bed Oil Tube with 52045, for oiling Feed Lifting and Feed Rock Shaft (front) Bearings.....
52045	9608	Bed Oil Tube Packing (felt).....
11680	840	Cloth Plate.....
389F	901	" " Screw.....
11363	825	Crank Connecting Rod.....
565c	898	" " " Hinge Screw....
1513J	890	" " " " " Nut.
19503	841	Feed Bar.....
307c	898	" " Screw Center.....
56814	—	" " " " 307c with 1513J..
1513J	890	" " " " Nut.....
11367	830	" Cam with two 445c.....
445c	900	" " Set Screw.....
11368	830	" Connecting Link.....
565c	898	" " " Hinge Screw.....
1513J	890	" " " " " Nut..
19791	924	" Dog, 17 teeth (11 teeth to the inch) for 19745.....
166E	899	Feed Dog Screw.....

NO.	PLATE	NAME
11593	838	Feed Forked Connection.....
565c	898	" " " " Hinge Screw....
1513j	890	" " " " " " Nut
19968	4420	" Lifting Rock Shaft with 134E, 2022 and 19967.....
19969	—	Feed Lifting Rock Shaft complete, Nos. 19814 and 19968.....
19814	4421	Feed Lifting Rock Shaft Crank with 346E, 1518j and 1866.....
346E	4453	Feed Lifting Rock Shaft Crank Clamping Screw.....
1866	900	Feed Lifting Rock Shaft Crank Roller with 372c.....
372c	898	Feed Lifting Rock Shaft Crank Roller Screw.....
1518j	907	Feed Lifting Rock Shaft Crank Roller Screw Nut.....
564c	898	Feed Lifting Rock Shaft Screw Center
58384	—	" " " " " "
		564c with 1508j.....
1508j	890	Feed Lifting Rock Shaft Screw Center Nut.....
19967	861	Feed Lifting Rock Shaft Wearing Block
2022	887	" " " " " "
		Position Pin.....
134E	900	Feed Lifting Rock Shaft Wearing Block Screw.....
11375	830	Feed Regulator.....
568E	898	" " " " Hinge Screw.....
50322D	4489	" " " " Thumb Screw.....
11598	838	" Rock Shaft.....
11599	—	Feed Rock Shaft complete, Nos. 11598 and 58447.....
58447	9627	Feed Rock Shaft Crank with 50124E.....
8873	887	" " " " Pin.....
50124E	4494	" " " " Set Screw.....
564c	898	" " " " Screw Center.....
58384	—	" " " " " " 564c with 1508j.....
1508j	890	Feed Rock Shaft Screw Center Nut.....
26159	894	Guide (10 in. face).....
254D	902	" Thumb Screw.....
11402	828	Lifting Presser Bar.....
19808	856	" " " Bell Crank.....
19809	—	" " " " " " 19808 with 611c and 19810.....

NO.	PLATE	NAME
19810	856	Lifting Presser Bar Bell Crank Adjusting Link with 1518j, 1828 and 2718.....
1828	899	Lifting Presser Bar Bell Crank Adjusting Link Roller with 372c.....
372c	898	Lifting Presser Bar Bell Crank Adjusting Link Roller Screw.....
1518j	907	Lifting Presser Bar Bell Crank Adjusting Link Roller Screw Nut.....
2718	897	Lifting Presser Bar Bell Crank Adjusting Link Roller Screw Nut Washer.....
611c	905	Lifting Presser Bar Bell Crank Adjusting Link Screw.....
51260D	9619	Lifting Presser Bar Bell Crank Hinge Screw.....
51609E	9620	Lifting Presser Bar Bell Crank Hinge Screw Nut.....
58402	9627	Lifting Presser Bar Guide Bracket with 159E, 453c and 460c.....
159E	901	Lifting Presser Bar Guide Bracket Ad- justing Screw.....
11405	830	Lifting Presser Bar Guide Bracket Guide
381E	899	" " " " " "
		Screw.....
453c	899	Lifting Presser Bar Guide Bracket Set Screw.....
11909	830	Lifting Presser Bar Lifter with 8761 and 8763.....
8760	888	Lifting Presser Bar Lifter Friction Washer
16D	899	" " " " Hinge Screw...
8761	890	" " " " Stop Pin.....
58401	9626	" " " " Lifting Link.....
524c	9619	" " " " " Cap Screw
8763	890	" " " " " H i n g e Stud.....
8973	862	Lifting Presser Bar Lifting Link Hinge Stud Pin.....
43267	4492	Lifting Presser Bar Lifting Link Hinge Stud Washer.....
258E	899	Lifting Presser Bar Screw Bushing.....
11409	827	" " " Spring.....
11465	853	" " " " Bracket with 353c.....
353c	899	Lifting Presser Bar Spring Bracket Set Screw.....
11466	853	Lifting Presser Bar Spring Bracket Set Screw Washer.....
11538	855	Needle Bar.....

NO.	PLATE	NAME
*11539	856	Needle Bar Connecting Link.....
566c	898	" " " " Hinge Screw
1513j	890	" " " " " "
		Nut.....
11383	887	Needle Bar Connecting Stud with two 445F.....
19981	—	Needle Bar Connecting Stud 11383 with 11539.....
445F	900	Needle Bar Connecting Stud Set Screw...
258E	899	" " Screw Bushing.....
19702	890	" Clamp with 680F and 11385.....
*11385	890	" " Gib.....
680F	862	" " Thumb Screw.....
58253	—	Oil Cup.....
11917	825	" " Cover.....
9084	889	" " " Hinge Pin.....
2205	887	" " " Latch Spring.....
207F	901	" " " " Screw.....
8953	874	" or Wax Stripper (felt).....
11918	888	" " " " Washer (steel) for 11917.....
8482	890	Oil or Wax Stripper Washer (steel) for 58253.....
207F	901	Oil or Wax Stripper Washer Screw.....
58254	4490	Oil Cup complete, Nos. 2205, 8482, 9084, 11917, 11918, 58253, two 8953 and three 207F.....
134E	900	Oil Cup Screw.....
58573	9625	Oscillating Rock Shaft.....
58566	—	Oscillating Rock Shaft complete, Nos. 1508J, 11165, 51237c, 58570, 58573 and 58586.....
58585	9625	Oscillating Rock Shaft Hinge Pin.....
58586	—	" " " " " 58585 with 1508J.....
1508J	890	Oscillating Rock Shaft Hinge Pin Nut...
51237c	9619	" " " " " Screw Bearing.....
1508J	890	Oscillating Rock Shaft Hinge Pin Screw Bearing Nut.....
11165	897	Oscillating Rock Shaft Oil Pad.....
58567	—	" " " " Tube with 58569.....
58570	9616	Oscillating Rock Shaft Oil Tube complete, Nos. 58567, 58568 and 127848.....

NO.	PLATE	NAME
58568	9616	Oscillating Rock Shaft Oil Tube Joint....
127848	9608	" " " " " Oil Cup.
*58569	—	" " " " " Sleeve...
11850	825	" Shaft.....
11393	887	" " Collar with two 453c....
453c	899	" " " Set Screw.....
11848	—	" " Crank.....
19696	4421	Oscillating Shaft Crank complete, Nos. 453c, 1513J, 5868 and 11848.....
40025	4492	Oscillating Shaft Crank Pin.....
453c	899	" " " Set Screw.....
9119	4421	" " " Slide Block.....
5868	4421	Oscillating Shaft Crank Slide Block com- plete, Nos. 190E, 1054c, 5968 and 9119.
190E	899	Oscillating Shaft Crank Slide Block Cap Screw.....
5968	887	Oscillating Shaft Crank Slide Block Cap Screw Washer.....
1054c	4421	Oscillating Shaft Crank Slide Block Screw Stud.....
1513J	890	Oscillating Shaft Crank Slide Block Screw Stud Nut.....
252E	898	Pressure Regulating Thumb Screw.....
11910	7268	Shuttle Bobbin.....
19977	7268	" Cylinder.....
58213	—	" " 19977 with 773F and 19979.....
58527	9621	Shuttle Cylinder Hinge Pin.....
58979	9611	" " Latch.....
12002	7268	" " " Pin.....
122419	9621	" " " Spring.....
58523	9612	" Frame.....
58524	—	" " 58523 with 12002, 58979 and 122419.....
773F	7268	Shuttle Tension Regulating Screw.....
19979	7268	" " Spring.....
58525	9613	Shuttle (cylinder) 3 in. diam., complete, Nos. 11910, 58213, 58524 and 58527....
11856	830	Shuttle Driver with 453c.....
2117	890	" " Pin.....
453c	899	" " Set Screw.....
11832	830	" Race Back.....
11833	889	" " " Position Pin.....
19577	864	" " " Spring.....
32D	901	" " " " Screw.....
11835	—	" " " Body.....

NO.	PLATE	NAME
11836	825	Shuttle Race complete, Nos. 32D, 11832, 11835, 19577 and two 11833.....
134E	900	Shuttle Race Screw.....
11837	825	" " Frame with 11838.....
670E	862	" " " Clamping Screw.....
11838	889	" " " Position Pin.....
11421	887	Tension Bracket.....
190E	899	" " Screw.....
8879	887	" Friction Washer (cloth).....
11423	888	" " (steel).....
1560C	903	" Regulating Thumb Nut.....
8905	887	" " " Washer
411E	898	" Screw Stud.....
58589	—	" " " 411E with 1560c.....
11422	888	" Spring.....
11044	897	" Wheel.....
11420	—	Tension (wheel) complete, Nos. 8905, 11044, 11422, 11423, 58589 and two 8879.....
11950	888	Thread Eyelet (side of arm).....
2102	888	" Retaining Disc.....
1560C	903	" " Regulating Thumb Nut
8905	887	" " " " Washer.....
686E	902	Thread Retaining Screw Stud.....
58590	—	" " " " 686E with 1560c.....
2103	888	Thread Retaining Spring.....
11041	—	Thread Retainer complete, Nos. 2103, 8905, 58590 and two 2102.....
11428	827	Thread Take-up Cam with two 434c....
8873	887	" " " Pin.....
434C	899	" " " Set Screw.....
58295	—	" " Lever.....
58296	4493	" " " 58295 with 1995...
58320	—	" " " 58296 with 50437D
50437D	4494	" " " Hinge Screw.....
1995	4452	" " " Roller and Screw Stud with 1518J.....
1518J	907	Thread Take-up Lever Roller and Screw Stud Nut.....
11052	887	Thread Take-up Spring.....
11431	888	" " " Regulator Plate
190E	899	" " " " " "
—	—	Adjusting Screw.....
19741	—	Throat Plate Body.....
19744	4400	" " Needle Hole Strip.....

NO.	PLATE	NAME
401D	899	Throat Plate Needle Hole Strip Screw....
19745	4400	Throat Plate complete for 19791, Nos. 19741, 19744 and two 401D.....
381D	899	Throat Plate Screw.....
*15404	—	Trade Mark.....
15405	4492	" " Rivet.....
19749	922	Vibrating Presser Bar.....
19750	922	Vibrating Presser Bar complete, Nos. 11739, 19749 and two 11740.....
14593	4401	Vibrating Presser Bar Guide Bracket with 448c and 1192c.....
19752	—	Vibrating Presser Bar Guide Bracket complete, Nos. 14593, 19751 and two 190E.
19751	4401	Vibrating Presser Bar Guide Bracket Cap with 9042.....
9042	890	Vibrating Presser Bar Guide Bracket Cap Hook.....
190E	899	Vibrating Presser Bar Guide Bracket Cap Screw.....
1192C	9620	Vibrating Presser Bar Guide Bracket Position Screw.....
448C	900	Vibrating Presser Bar Guide Bracket Set Screw.....
14596	862	Vibrating Presser Bar Hinge Pin.....
460C	4451	" " " " " Set Screw.
8734	886	" " " Spring.....
11739	886	" " " Bracket with 9042.....
9042	890	Vibrating Presser Bar Spring Bracket Hook.....
11740	879	Vibrating Presser Bar Spring Bracket Rivet.....
19746	4400	Vibrating Presser Foot.....
898E	901	" " " Screw.....
1547J	903	" " " " Nut.....

**LIST OF PARTS COMPLETE
FOR
MACHINE No. 7-14**

FOR HARNESS AND OTHER WORK IN LEATHER NOT MORE THAN $\frac{3}{8}$ INCH THICK. MAKES "SET" STITCH BY USE OF POINTS ON PRESSER FOOT. HAS PRESSER FEED POINT FOR $\frac{1}{8}$ INCH STITCH. PRESSER FEED POINTS FOR $\frac{1}{4}$, $\frac{3}{8}$, $\frac{1}{10}$ AND $\frac{1}{12}$ INCH STITCH CAN BE FURNISHED IF SO ORDERED AT AN EXTRA COST. UPPER FEED, FOOT LIFTER AND S. D. A. STITCH $\frac{3}{32}$ IN. TO $\frac{1}{4}$ INCH LONG.

NO.	PLATE	NAME
*19961	—	Arm with 15404 and two 15405.....
8702	887	" Dowel Pin.....
127848	9608	" Oil Cup, for oiling Arm Shaft Front and Back Bearings.....
58504	9608	Arm Oil Tube, for oiling Arm Shaft Intermediate Bearing.....
50348E	9619	Arm Screw.....
58329	4495	" Shaft.....
11354	830	" " Bushing.....
437C	899	" " " Set Screw.....
949E	4494	" " Screw.....
9842	4492	" " " Washer.....
19525	847	" Side Cover.....
65D	899	" " " Hinge Screw.....
8708	827	" Spool Pin.....
11241	858	" " " Washer (cloth).....
122301	—	Balance Wheel with two 354c.....
122302	4496	" " 122301 with 11442, 122469, two 1402E and four 401E.....
25362	9621	Balance Wheel Ball, size $\frac{1}{8}$ in.....
122303	—	" " " Ring.....
122304	4493	" " " " 122303 with eighteen 25362.....
122306	4493	Balance Wheel Ball Washer (left).....
122469	9616	" " " " (right).....
1402E	4494	" " " " " Screw.....
11442	896	" " Friction Washer (paper)...
401E	899	" " " " " Screw....
354C	899	" " Set Screw.....
*11359	—	Bed.....
24131	9608	" Oil Tube with 52045, for oiling Feed Rock Shaft (back) Bearing.....

NO.	PLATE	NAME
58549	9608	Bed Oil Tube with 52045, for oiling Feed Lifting and Feed Rock Shaft (front) Bearings.....
52045	9608	Bed Oil Tube Packing (felt).....
11363	825	Crank Connecting Rod.....
565C	898	" " " Hinge Screw.....
1513J	890	" " " " " Nut
19544	845	Feed Bar.....
19546	845	" " Guide Bracket (lower) with 456c and 1192c.....
19726	—	Feed Bar Guide Bracket (lower) complete, Nos. 19546, 19547 and two 190E.....
19547	845	Feed Bar Guide Bracket (lower) Cap....
190E	899	" " " " " " Screw
1192C	9620	" " " " " " Position Screw.....
456C	9620	Feed Bar Guide Bracket (lower) Set Screw.....
19545	884	Feed Bar Guide Bracket (upper).....
145E	899	" " " " " " Screw...
11071	878	" " Hinge Bracket with 145E, 193F, 434c and 832c.....
145E	899	Feed Bar Hinge Bracket Adjusting Screw.
19548	845	" " " " " Guide Plate....
381E	899	" " " " " " " Screw
832C	9620	" " " " " Set Screw (long)
434C	899	" " " " " " " (short)
448C	900	" " " " " Support Screw...
1520J	905	" " " " " " " Nut
11072	889	" " " " " Pin.....
193F	901	" " " " " Set Screw.....
58511	9623	" Cam with two 445c.....
445C	900	" " Set Screw.....
19527	845	" Connecting Link.....
65D	899	" " " Hinge Screw.....
11014	884	" Point.....
NOTE: In ordering No. 11014 state number of stitches per inch		
11075	921	Feed Point Packing.....
166E	899	" " Screw.....
19528	865	" Regulator with 231c and 453c....
912C	903	" " Adjusting Screw.....
1596D	903	" " " " " Nut...
19529	9621	" " " " " Sleeve.
231C	901	" " " " " S t o p Screw.....

NO.	PLATE	NAME
3012	853	Feed Regulator Pin.....
453c	899	" " Set Screw.....
19530	873	" " Shaft.....
11393	887	" " " Collar with two 453c.....
453c	899	Feed Regulator Shaft Collar Set Screw....
11708	846	" " " Driving Crank with 453c and 1804.....
3012	853	Feed Regulator Shaft Driving Crank Pin.....
1804	899	Feed Regulator Shaft Driving Crank Roller and Stud.....
453c	899	Feed Regulator Shaft Driving Crank Set Screw.....
11698	847	Feed Shaft.....
19531	865	" " Crank with 453c, 1518j and 1845.....
2117	890	Feed Shaft Crank Pin.....
1845	899	" " " Roller and Screw Stud
1518j	907	" " " " " " " "
		Nut.....
453c	899	Feed Shaft Crank Set Screw.....
19532	869	" " Driving Crank with 453c....
2117	890	" " " " Pin.....
453c	899	" " " " Set Screw.....
25881	894	Guide (6 in. face).....
254d	902	" Thumb Screw.....
11380	828	Needle Bar.....
*11539	856	" " Connecting Link.....
566	898	" " " " Hinge Screw
1513j	890	" " " " " " " "
		Nut.....
11383	887	Needle Bar Connecting Stud with two 445f.....
19981	—	Needle Bar Connecting Stud 11383 with 11539.....
445f	900	Needle Bar Connecting Stud Set Screw....
258E	899	" " Screw Bushing.....
19702	890	" Clamp with 680f and 11385.....
*11385	890	" " Gib.....
680f	862	" " Thumb Screw.....
11916	849	" Plate for 19720 to 19722.....
381d	899	" " Screw.....
58253	—	Oil Cup.....
11917	825	" " Cover.....
9084	889	" " " Hinge Pin.....
2205	887	" " " Latch Spring.....

NO.	PLATE	NAME
207F	901	Oil Cup Cover Latch Spring Screw.....
8953	874	" or Wax Stripper (felt).....
11918	888	" " " " Washer (steel) for 11917.....
8482	890	Oil or Wax Stripper Washer (steel) for 58253.....
207F	901	Oil or Wax Stripper Washer Screw.....
58254	4490	Oil Cup complete, Nos. 2205, 8482, 9034, 11917, 11918, 58253, two 8953 and three 207f.....
134E	900	Oil Cup Screw.....
58571	9625	Oscillating Rock Shaft.....
58572	—	Oscillating Rock Shaft complete, Nos. 1508j, 11165, 51237c, 58570, 58571 and 58586.....
58585	9625	Oscillating Rock Shaft Hinge Pin.....
58586	—	" " " " " " 58585 with 1508j.....
1508j	890	Oscillating Rock Shaft Hinge Pin Nut..
51237c	9619	" " " " " " Screw Bearing.....
1508j	890	Oscillating Rock Shaft Hinge Pin Screw Bearing Nut.....
11165	897	Oscillating Rock Shaft Oil Pad.....
58567	—	" " " " Tube with 58569.....
58570	9616	Oscillating Rock Shaft Oil Tube complete, Nos. 58567, 58568 and 127848.....
58568	9616	Oscillating Rock Shaft Oil Tube Joint....
127848	9608	" " " " " Oil Cup.
*58569	—	" " " " " Sleeve...
11850	825	" Shaft.....
11393	887	" " Collar with two 453c....
453c	899	" " " Set Screw.....
11848	—	" " Crank.....
19696	4421	Oscillating Shaft Crank complete, Nos. 453c, 1513j, 5868 and 11848.....
40025	4492	Oscillating Shaft Crank Pin.....
453c	899	" " " Set Screw.....
9119	4421	" " " Slide Block.....
5868	4421	Oscillating Shaft Crank Slide Block com- plete, Nos. 190E, 1054c, 5968 and 9119
190E	899	Oscillating Shaft Crank Slide Block Cap Screw.....
5968	887	Oscillating Shaft Crank Slide Block Cap Screw Washer.....

NO.	PLATE	NAME
1054c	4421	Oscillating Shaft Crank Slide Block Screw Stud.....
1513j	890	Oscillating Shaft Crank Slide Block Screw Stud Nut.....
19878	4427	Presser Bar.....
19879	—	" " 19878 with 2049, 19882, 64052 and two 399E.....
19880	4401	Presser Bar Clutch.....
19881	—	Presser Bar Clutch complete, Nos. 164E, 1916, 19880 and 41544.....
11062	922	Presser Bar Clutch Hinge Bracket with 150E.....
159E	901	Presser Bar Clutch Hinge Bracket Adjusting Screw.....
190E	899	Presser Bar Clutch Hinge Bracket Stop Screw.....
1549j	903	Presser Bar Clutch Hinge Bracket Stop Screw Nut.....
25F	901	Presser Bar Clutch Hinge Screw.....
1916	4401	" " " Roller.....
164E	899	" " " Cap Screw.....
41544	4415	" " " " " Washer.....
11909	830	" " Lifter with 8761 and 8763....
8760	888	" " " Friction Washer.....
16D	899	" " " Hinge Screw.....
8761	890	" " " Stop Pin.....
19538	845	" " " Lifting Bell Crank.....
19539	—	" " " " " Adjusting Link.....
19540	845	Presser Bar Lifting Bell Crank Adjusting Link complete, Nos. 1518j, 1828, 2718 and 19539.....
1828	899	Presser Bar Lifting Bell Crank Adjusting Link Roller with 372c.....
372c	898	Presser Bar Lifting Bell Crank Adjusting Link Roller Screw.....
1518j	907	Presser Bar Lifting Bell Crank Adjusting Link Roller Screw Nut.....
2718	897	Presser Bar Lifting Bell Crank Adjusting Link Roller Screw Nut Washer.....
611c	905	Presser Bar Lifting Bell Crank Adjusting Link Screw.....
51260D	9619	Presser Bar Lifting Bell Crank Hinge Screw.....
51609E	9620	Presser Bar Lifting Bell Crank Hinge Screw Nut.....

NO.	PLATE	NAME
19541	848	Presser Bar Lifting Link.....
65D	899	" " " " Hinge Screw.....
8763	890	" " " " Stud.....
8973	862	" " " " " Pin....
43267	4492	" " " " " Washer.....
19882	4401	" " Rack.....
399E	4401	" " " Screw.....
257E	902	" " Screw Bushing.....
11031	863	" " Spring (flat).....
58252	4493	" " " Bracket.....
1177E	4494	" " " " Screw.....
11661	9608	" " " Guide Pin.....
50323D	4489	" " " Regulating Thumb Screw.....
11033	885	Presser Bar Spring (spiral).....
19883	4401	" " " " Collar.....
19719	921	" Foot, for sewing straps with buckles on horse blankets.....
19720	921	Presser Foot (stitch set) with extended toe on right hand side.....
19721	921	Presser Foot (stitch set) for stitching cruppers.....
19722	921	Presser Foot (stitch set) double toe.....
11075	921	" " " Packing.....
166E	899	" " " Screw.....
1326E	4451	Pressure Regulating Thumb Screw.....
11910	7268	Shuttle Bobbin.....
19977	7268	" " Cylinder.....
58213	—	" " " 19977 with 773F and 19979.....
58527	9621	Shuttle Cylinder Hinge Pin.....
58979	9611	" " " Latch.....
12002	7268	" " " Pin.....
122419	9621	" " " Spring.....
58523	9612	" " " Frame.....
58524	—	" " " 58523 with 12002, 58979 and 122419.....
773F	7268	Shuttle Tension Regulating Screw.....
19979	7268	" " " Spring.....
58525	9613	Shuttle (cylinder) 3 in. diam., complete, Nos. 11910, 58213, 58524 and 58527....
11856	830	Shuttle Driver with 453c.....
2117	890	" " " Pin.....
453c	899	" " " Set Screw.....
11832	830	" Race Back.....
11833	889	" " " Position Pin.....
19577	864	" " " Spring.....

NO.	PLATE	NAME
	32D	Shuttle Race Back Spring Screw.....
11835	—	“ “ Body.....
11836	825	Shuttle Race complete, Nos. 32D, 11832, 11835, 19577 and two 11833.....
	134E	Shuttle Race Screw.....
11837	825	“ “ Frame with 11838.....
	670E	“ “ “ Clamping Screw.....
11838	889	“ “ “ Position Pin.....
11418	858	“ “ Slide (left).....
11500	851	“ “ “ (right).....
	180D	“ “ “ “ Screw.....
19542	874	Tension Bracket.....
	193F	“ “ Screw.....
	8879	“ Friction Washer (cloth).....
11423	888	“ “ “ (steel).....
1560c	903	Regulating Thumb Nut.....
8905	887	“ “ “ “ Washer.....
	411E	“ Screw Stud.....
58589	—	“ “ “ 411E with 1560c.....
11422	888	“ Spring.....
11044	897	“ Wheel.....
11420	—	Tension (wheel) complete, Nos. 8905, 11044, 11422, 11423, 58589 and two 8879
11950	888	Thread Eyelet (side of arm).....
2102	888	“ Retaining Disc.....
1560c	903	“ “ Regulating Thumb Nut
8905	887	“ “ “ “ “ “
		Washer.....
686E	902	Thread Retaining Screw Stud.....
58590	—	“ “ “ “ 686E with 1560c.....
	2103	888 Thread Retaining Spring.....
11041	—	Thread Retainer complete, Nos. 2103, 8905, 58590 and two 2102.....
11428	827	Thread Take-up Cam with two 434c.....
	8873	887 “ “ “ Pin.....
	434c	899 “ “ “ Set Screw.....
58295	—	“ “ “ Lever.....
58296	4493	“ “ “ 58295 with 1995..
58320	—	“ “ “ 58296 with 50437D
50437D	4494	“ “ “ Hinge Screw.....
	1995	4452 “ “ “ Roller and Screw Stud with 1518J.....
	1518J	907 Thread Take-up Lever Roller and Screw Stud Nut.....
11052	887	Thread Take-up Spring.....

NO.	PLATE	NAME
11431	888	Thread Take-up Spring Regulator Plate
	190E	899 “ “ “ “ “
		Adjusting Screw.....
19543	884	Thread Take-up Spring Staple.....
	690E	4451 “ “ “ “ Screw.....
41544	4415	“ “ “ “ “ Washer
*15404	—	Trade Mark.....
15405	4492	“ “ Rivet.....

MACHINE No. 7-15

HAS BELT SHIFTER FOR FLAT BELT, OTHERWISE
SAME AS NO. 7-13.

NO.	PLATE	NAME
11878	838	Arm Shaft, in place of 58329.....
58407	9631	Balance Wheel and Pulley (tight) with two 354c, in place of 122302.....

Genuine Singer Needles should be used
in Singer Machines.
These Needles and their Containers
are marked with the
Company's Trade Mark "SIMANCO." 1

Needles in Containers marked
"For Singer Machines"
are not Singer made needles. 2

LIST OF PARTS COMPLETE

FOR

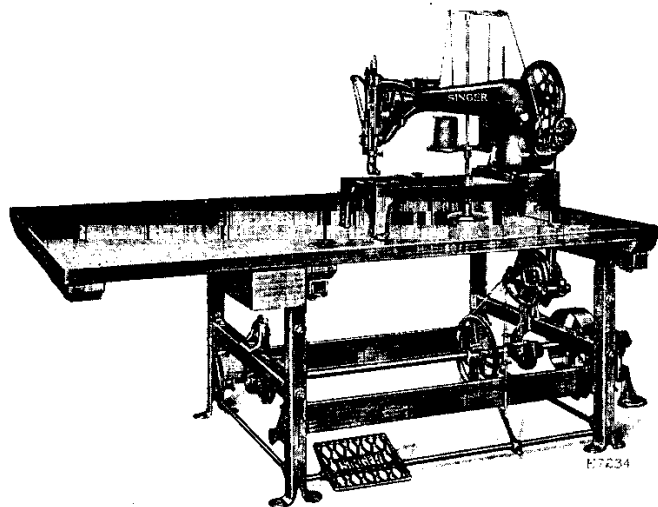

MACHINE NO. 7-16 ON TABLE No. 5274 AND STEEL WORK
No. 126624

(FOR DESCRIPTION OF TABLE AND STEEL WORK
SEE FORM 8801)

MACHINE No. 7-16

FOR STRAINERS MADE OF CAMEL'S HAIR, FOR COTTON SEED
OIL. FITTED FOR $\frac{1}{8}$ TO $\frac{1}{2}$ INCH STITCH, NO. 31 NEEDLE
AND HEAVY THREAD. DROP FEED.

NO.	PLATE	NAME
*19959	—	Arm with 15404 and two 15405.....
8702	887	" Dowel Pin.....
127848	9608	" Oil Cup, for oiling Arm Shaft Front and Back Bearings
58564	9608	Arm Oil Tube, for oiling Arm Shaft Inter- mediate Bearing.....

PARTS FOR MACHINE No. 7-16

61

NO.	PLATE	NAME
50348E	9619	Arm Screw.....
11353	825	" Shaft.....
11354	830	" " Bushing.....
437c	899	" " " Set Screw.....
11913	825	" Side Cover.....
65D	899	" " " Hinge Screw.....
8708	827	" Spool Pin.....
11241	858	" " " Washer (cloth).....
58411	9631	Balance Wheel with two 354c, for Under Driver.....
11358	896	Balance Wheel (two speed) with two 354c, for Stand.....
354c	899	Balance Wheel Set Screw.....
*11359	—	Bed.....
24131	9608	" Oil Tube with 52045, for oiling Feed Rock Shaft (back) Bearing.....
58549	9608	Bed Oil Tube with 52045, for oiling Feed Lifting and Rock Shaft (front) Bearings
52045	9608	Bed Oil Tube Packing (felt).....
11363	825	Crank Connecting Rod.....
565c	898	" " " Hinge Screw.....
1513J	890	" " " " " Nut
11365	828	Feed Bar.....
307c	898	" " Screw Center.....
56814	—	" " " " 307c with 1513J..
1513J	890	" " " " Nut.....
11367	830	" Cam with two 445c.....
445c	900	" " Set Screw.....
11368	830	" Connecting Link.....
565c	898	" " " Hinge Screw.....
1513J	890	" " " " " Nut..
19803	4428	" Dog, 15 teeth (10 teeth to the inch) for 19807 and 58292.....
166J	899	Feed Dog Screw.....
11370	825	" Forked Connection.....
565c	898	" " " Hinge Screw....
1513J	890	" " " " " Nut
19970	4420	" Lifting Rock Shaft with 134E, 2022 and 19967.....
19971	—	Feed Lifting Rock Shaft complete, Nos. 19812 and 19970.....
19812	4421	Feed Lifting Rock Shaft Crank with 346E and 1861.....
346E	4453	Feed Lifting Rock Shaft Crank Clamping Screw.....
1861	862	Feed Lifting Rock Shaft Crank Roller and Stud.....

NO.	PLATE	NAME
564c	898	Feed Lifting Rock Shaft Screw Center
58384	—	“ “ “ “ “ “
		564c with 1508J.....
1508J	890	Feed Lifting Rock Shaft Screw Center Nut.....
19967	861	Feed Lifting Rock Shaft Wearing Block
2022	887	“ “ “ “ “ “
		Position Pin.....
134E	900	Feed Lifting Rock Shaft Wearing Block Screw.....
11375	830	Feed Regulator.....
568E	898	“ “ Hinge Screw.....
50322D	4489	“ “ Thumb Screw.....
58233	4490	“ Rock Shaft.....
58234	—	Feed Rock Shaft complete, Nos. 58233 and 58235.....
58235	4491	Feed Rock Shaft Crank with 346E.....
346E	4453	“ “ “ “ Clamping Screw.....
564c	898	“ “ “ Screw Center.....
58384	—	“ “ “ “ “ 564c with 1508J.....
1508J	890	Feed Rock Shaft Screw Center Nut.....
25881	894	Guide (6 in. face).....
254D	902	“ Thumb Screw.....
11402	828	Lifting Presser Bar.....
19808	856	“ “ “ Bell Crank.....
19809	—	“ “ “ “ “ 19808 with 611c and 19810.....
19810	856	Lifting Presser Bar Bell Crank Adjusting Link with 1518J, 1828 and 2718.....
1828	899	Lifting Presser Bar Bell Crank Adjusting Link Roller with 372c.....
372c	898	Lifting Presser Bar Bell Crank Adjusting Link Roller Screw.....
1518J	907	Lifting Presser Bar Bell Crank Adjusting Link Roller Screw Nut.....
2718	897	Lifting Presser Bar Bell Crank Adjusting Link Roller Screw Nut Washer.....
611c	905	Lifting Presser Bar Bell Crank Adjusting Link Screw.....
51260D	9619	Lifting Presser Bar Bell Crank Hinge Screw.....
51609E	9620	Lifting Presser Bar Bell Crank Hinge Screw Nut.....
58402	9627	Lifting Presser Bar Guide Bracket with 159E, 453c and 460c.....

NO.	PLATE	NAME
159E	901	Lifting Presser Bar Guide Bracket Adjusting Screw.....
11405	830	Lifting Presser Bar Guide Bracket Guide
381E	899	“ “ “ “ “ “
		Screw.....
453c	899	Lifting Presser Bar Guide Bracket Set Screw.....
11909	830	Lifting Presser Bar Lifter with 8761 and 8763.....
8760	888	Lifting Presser Bar Lifter Friction Washer
16D	899	“ “ “ “ Hinge Screw....
8761	890	“ “ “ “ Stop Pin.....
11906	827	“ “ “ Lifting Link.....
524c	9619	“ “ “ “ “ Cap Screw
8763	890	“ “ “ “ “ H i n g e Stud.....
8973	862	Lifting Presser Bar Lifting Link Hinge Stud Pin.....
43267	4492	Lifting Presser Bar Lifting Link Hinge Stud Washer.....
258E	899	Lifting Presser Bar Screw Bushing.....
11409	827	“ “ “ Spring.....
11465	853	“ “ “ “ Bracket with 353c.....
353c	899	Lifting Presser Bar Spring Bracket Set Screw.....
11466	853	Lifting Presser Bar Spring Bracket Set Screw Washer.....
11726	848	Needle Bar.....
*11539	856	“ “ Connecting Link.....
566c	898	“ “ “ “ Hinge Screw
1513J	890	“ “ “ “ “ “
		Nut.....
11383	887	Needle Bar Connecting Stud with two 445F.....
19981	—	Needle Bar Connecting Stud 11383 with 11539.....
445F	900	Needle Bar Connecting Stud Set Screw....
258E	899	“ “ Screw Bushing.....
19702	890	“ Clamp with 680F and 11385.....
*11385	890	“ “ Gib.....
680F	862	“ “ Thumb Screw.....
58253	—	Oil Cup.....
11917	825	“ “ Cover.....
9084	889	“ “ “ Hinge Pin.....
2205	887	“ “ “ Latch Spring.....
207P	901	“ “ “ “ “ Screw.....

NO.	PLATE	NAME
8953	874	Oil or Wax Stripper (felt).....
11918	888	“ “ “ “ Washer (steel) for 11917.....
8482	890	Oil or Wax Stripper Washer (steel) for 58253.....
207F	901	Oil or Wax Stripper Washer Screw.....
58254	4490	Oil Cup complete, Nos. 2205, 8482, 9084, 11917, 11918, 58253, two 8953 and three 207F.....
134E	900	Oil Cup Screw.....
58573	9625	Oscillating Rock Shaft.....
58566	—	Oscillating Rock Shaft complete, Nos. 1508J, 11165, 51237c, 58570, 58573, and 58586.....
58585	9625	Oscillating Rock Shaft Hinge Pin.....
58586	—	“ “ “ “ “ 58585 with 1508J.....
1508J	890	Oscillating Rock Shaft Hinge Pin Nut....
51237c	9619	“ “ “ “ “ Screw Bearing.....
1508J	890	Oscillating Rock Shaft Hinge Pin Screw Bearing Nut.....
11165	897	Oscillating Rock Shaft Oil Pad.....
58567	—	“ “ “ “ “ Tube with 58569.....
58570	9616	Oscillating Rock Shaft Oil Tube complete, Nos. 58567, 58568 and 127848.....
58568	9616	Oscillating Rock Shaft Oil Tube Joint....
127848	9608	“ “ “ “ “ Oil Cup..
*58569	—	“ “ “ “ “ Sleeve...
11850	825	“ Shaft.....
11393	887	“ Collar with two 453c....
453c	899	“ “ “ Set Screw.....
11848	—	“ “ Crank.....
19096	4421	Oscillating Shaft Crank complete, Nos. 453c, 1513J, 5868 and 11848.....
40025	4492	Oscillating Shaft Crank Pin.....
453c	899	“ “ “ Set Screw.....
9119	4421	“ “ “ Slide Block.....
5868	4421	Oscillating Shaft Crank Slide Block com- plete, Nos. 190E, 1054c, 5968 and 9119.
190E	899	Oscillating Shaft Crank Slide Block Cap Screw.....
5968	887	Oscillating Shaft Crank Slide Block Cap Screw Washer.....
1054c	4421	Oscillating Shaft Crank Slide Block Screw Stud.....

NO.	PLATE	NAME
1513J	890	Oscillating Shaft Crank Slide Block Screw Stud Nut.....
252E	898	Pressure Regulating Thumb Screw.....
11910	7268	Shuttle Bobbin.....
19977	7268	“ Cylinder.....
58404	—	“ “ 19977 with 773F and 58381.....
58527	9621	Shuttle Cylinder Hinge Pin.....
58979	9611	“ “ Latch.....
12002	7268	“ “ “ Pin.....
122419	9621	“ “ “ Spring.....
58523	9612	“ Frame.....
58524	—	“ “ 58523 with 12002, 58979 and 122419.....
773F	7268	Shuttle Tension Regulating Screw.....
58381	9622	“ “ Spring.....
58526	9613	Shuttle (cylinder) 3 in. diam., complete, Nos. 11910, 58404, 58524 and 58527....
11727	4435	Shuttle Driver with 453c.....
2117	890	“ “ Pin.....
453c	899	“ “ Set Screw.....
11832	830	“ Race Back.....
11833	889	“ “ “ Position Pin.....
19577	864	“ “ “ Spring.....
32D	901	“ “ “ “ Screw.....
11835	—	“ “ “ Body.....
11836	825	Shuttle Race complete, Nos. 32D, 11832, 11835, 19577 and two 11833.....
134E	900	Shuttle Race Screw.....
11837	825	“ “ Frame with 11838.....
670E	862	“ “ “ Clamping Screw.....
11838	889	“ “ “ Position Pin.....
11418	858	“ “ Slide (left).....
11500	851	“ “ “ (right).....
180D	901	“ “ “ “ Screw.....
11421	887	Tension Bracket.....
190E	899	“ “ Screw.....
8879	887	“ Friction Washer (cloth).....
11423	888	“ “ “ (steel).....
1560c	903	“ Regulating Thumb Nut.....
8905	887	“ “ “ “ Washer
411E	898	“ Screw Stud.....
58589	—	“ “ “ 411E with 1560c....
8791	888	“ Spring.....
11044	897	“ Wheel.....
58317	—	Tension (wheel) complete, Nos. 8791, 8905, 11044, 11423, 58589 and two 8879.....

66 PARTS FOR MACHINE No. 7-16

NO.	PLATE	NAME
11950	888	Thread Eyelet (side of arm).....
2102	888	" Retaining Disc.....
1560c	903	" " Regulating Thumb Nut
8905	887	" " " " " "
		Washer.....
686E	902	Thread Retaining Screw Stud.....
58590	—	" " " " 686E with 1560c.....
2103	888	Thread Retaining Spring.....
11041	—	Thread Retainer complete, Nos. 2103, 8905, 58590 and two 2102.....
11428	827	Thread Take-up Cam with two 434c....
8873	887	" " " Pin.....
434c	899	" " " Set Screw.....
58299	—	" " Lever.....
58300	4493	" " " 58299 with 1948 and 1995.....
58315	—	Thread Take-up Lever 58300 with 50437D
50437D	4494	" " " Hinge Screw.....
1995	4452	" " " Roller and Screw Stud with 1518J.....
1518J	907	Thread Take-up Lever Roller and Screw Stud Nut.....
1948	4452	Thread Take-up Lever Thread Guiding Roller and Screw Stud.....
11052	887	Thread Take-up Spring.....
11431	888	" " " Regulator Plate
190E	899	" " " " " "
		Adjusting Screw.....
19804	—	Throat Plate Body.....
19805	—	" " Needle Plate (large oblong needle hole).....
19806	4428	Throat Plate Needle Plate (small oblong needle hole).....
219F	901	Throat Plate Needle Plate Screw.....
19807	4428	Throat Plate complete (small oblong needle hole) for 19803, Nos. 219F, 19804 and 19806.....
58292	—	Throat Plate complete (large oblong needle hole) for 19803, Nos. 219F, 19804 and 19805.....
*15404	—	Trade Mark.....
15405	4492	" " Rivet.....
381D	899	Throat Plate Screw.....
14592	922	Vibrating Presser Bar.....
14593	4401	" " " Guide Bracket with 448c and 1192c.....

PARTS FOR MACHINE No. 7-16 67

NO.	PLATE	NAME
14594	—	Vibrating Presser Bar Guide Bracket com- plete, Nos. 231c, 11472, 14593, 14595 and two 190E.....
14595	4401	Vibrating Presser Bar Guide Bracket Cap
190E	899	" " " " " "
		Screw.....
1192c	9620	Vibrating Presser Bar Guide Bracket Position Screw.....
448c	900	Vibrating Presser Bar Guide Bracket Set Screw.....
14596	862	Vibrating Presser Bar Hinge Pin.....
460c	4451	" " " " " Set Screw
58556	9626	" " " Spring.....
11472	853	" " " Bracket....
231c	901	" " " " " Screw
14597	4416	" " Foot.....
58406	9618	" " " for No. 31 Needle.
898E	901	" " " Screw.....
1547J	903	" " " " Nut.....

MACHINE No. 7-17

HAS S. D. A.

OTHERWISE SAME AS NO. 7-16

NO.	PLATE	NAME
58329	4495	Arm Shaft, in place of 11353.....
949E	4494	" " " Screw.....
9842	4492	" " " Washer.....
122301	—	Balance Wheel with two 354c.....
122302	4496	" " 122301 with 11442, 122469, two 1402E and four 401E, in place of 11358 and 58411.....
25362	9621	Balance Wheel Ball, size $\frac{1}{8}$ in.....
122303	—	" " " Ring.....
122304	4493	" " " " 122303 with eighteen 25362.....
122306	4493	Balance Wheel Ball Washer (left).....
122469	9616	" " " " (right).....
1402E	4494	" " " " " Screw
11442	896	" " Friction Washer.....
401E	899	" " " " " Screw..

8658—5

From the library of: Diamond Needle Corp

MACHINE No. 7-18

HAS BELT SHIFTER FOR FLAT BELT.

OTHERWISE SAME AS NO. 7-16

NO.	PLATE	NAME
11878	838	Arm Shaft, in place of 11353.....
58407	9631	Balance Wheel and Pulley (tight) with two 354c.....

MACHINE No. 7-20

FOR STITCHING CLOSE TO A SHOULDER AND IN CORNERS IN LEATHER. THE NEEDLE DESCENDS ABOUT $\frac{1}{8}$ INCH FROM THE EXTREME END OF BED PLATE. HAS PRESSER FEED POINT FOR $\frac{1}{8}$ INCH "SET" STITCH, OR FURNISHED WITH PRESSER WITHOUT FEED POINTS. PRESSER FEED POINTS FOR $\frac{1}{4}$, $\frac{1}{6}$, $\frac{1}{10}$ AND $\frac{1}{12}$ INCH STITCH CAN BE FURNISHED IF SO ORDERED AT AN EXTRA COST. UPPER FEED, FOOT LIFTER AND S. D. A. STITCH $\frac{3}{32}$ IN. TO $\frac{1}{4}$ IN. LONG.

This machine is the same as No. 7-14
with the following exceptions:

NO.	PLATE	NAME
*11746	—	Bed, in place of 11359.....
19554	874	Needle Plate, in place of 11916.....
19549	873	Shuttle Race Body, in place of 11835.....
19550	873	" " Cap.....
19551	—	Shuttle Race Cap complete, Nos. 11040, 19550 and two 664j.....
11040	9621	Shuttle Race Cap Latch Spring.....
664j	901	" " " " " Screw....
96d	901	" " " " " Screw.....
19552	—	Shuttle Race complete, Nos. 32d, 11832, 19549, 19551, 19577 and two each 96d and 11833, in place of 11836.....
19553	873	Shuttle Race Slide, in place of 11418 and 11500.....

LIST OF PARTS COMPLETE

FOR

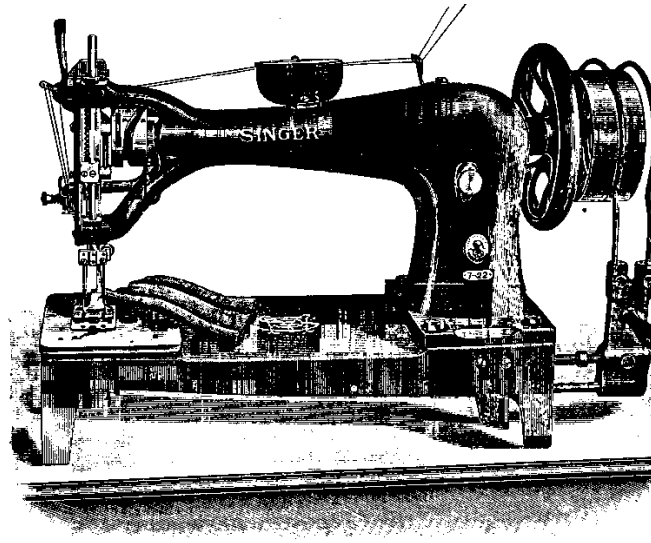
**MACHINE No. 7-22**

HAS TWO NEEDLES, TWO CYLINDER SHUTTLES NOS. 58516 AND 58521. GAUGES FROM $\frac{3}{4}$ TO 1 INCH. CAN BE FURNISHED IN GAUGES FROM 1 INCH UP TO $1\frac{1}{2}$ INCHES AT AN ADDITION OF \$55.00 TO THE REGULAR SELLING PRICE OF THE MACHINE. HAS DROP FEED, ADJUSTABLE PRESSER, EITHER VIBRATING OR STATIONARY AND BELT SHIFTER.

NO.	PLATE	NAME
*19962	—	Arm with 11559, 11560, 15404 and two each 128e, 612e and 15405.....
8702	887	Arm Dowel Pin.....
127848	9608	" Oil Cup, for oiling Arm Shaft Front and Back Bearings.....
58564	9608	Arm Oil Tube, for oiling Arm Shaft Intermediate Bearing.....

NO.	PLATE	NAME
50348E	9619	Arm Screw.....
11878	838	" Shaft.....
11354	830	" " Bushing.....
437c	899	" " " Set Screw.....
11913	825	" Side Cover.....
65D	899	" " " Hinge Screw.....
58407	9631	Balance Wheel and Pulley (tight) with two 354c.....
354c	899	Balance Wheel and Pulley (tight) Set Screw.....
*19556	—	Bed.....
24131	9608	" Oil Tube with 52045, for oiling Feed Rock Shaft (back) Bearing.....
58549	9608	Bed Oil Tube with 52045, for oiling Feed Lifting and Feed Rock Shaft (front) Bearings.....
52045	9608	Bed Oil Tube Packing (felt).....
58218	4497	Cloth Plate with 58219, 58220 and four 58221.....
*58219	—	Cloth Plate Packing (back).....
*58220	—	" " " (front).....
58221	4492	" " " Rivet.....
389F	901	" " Screw.....
11363	825	Crank Connecting Rod.....
565c	898	" " " Hinge Screw.....
1513J	890	" " " " Nut
58216	4497	Face Plate.....
58217	—	Face Plate complete, Nos. 910c, 11867, 11875, 19590, 19701, 19866, 19886, 41544, 58216, 58466, 58579 or 58580 and three 164E.....
58466	9608	Face Plate Thread Eyelet.....
19590	865	" " " Guard.....
164E	899	" " " Screw.....
161E	901	" " Screw.....
58327	4493	Feed Bar.....
307c	898	" " Screw Center.....
56814	—	" " " 307c with 1513J..
1513J	890	" " " " Nut.....
11367	830	" Cam with two 445c.....
445c	900	" " Set Screw.....
11368	830	" Connecting Link.....
565c	898	" " " Hinge Screw.....
1513J	890	" " " " " Nut..
58328	4498	" Dog, 13 teeth (10 teeth to the inch) for 19593.....

NO.	PLATE	NAME
381E	899	Feed Dog Screw.....
11370	825	" Forked Connection.....
565c	898	" " " Hinge Screw.....
1513J	890	" " " " " Nut
19970	4420	" Lifting Rock Shaft with 134E, 2022 and 19967.....
19971	—	Feed Lifting Rock Shaft complete, Nos. 19812 and 19970.....
19812	4421	Feed Lifting Rock Shaft Crank with 346E and 1861.....
346E	4453	Feed Lifting Rock Shaft Crank Clamp- ing Screw.....
1861	862	Feed Lifting Rock Shaft Crank Roller and Stud.....
564c	898	Feed Lifting Rock Shaft Screw Center
58384	—	" " " " " " "
		564c with 1508J.....
1508J	890	Feed Lifting Rock Shaft Screw Center Nut.....
19967	861	Feed Lifting Rock Shaft Wearing Block
2022	887	" " " " " " "
		Position Pin.....
134E	900	Feed Lifting Rock Shaft Wearing Block Screw.....
11375	830	Feed Regulator.....
568E	898	" " Hinge Screw.....
50322D	4489	" " Thumb Screw.....
58233	4490	" Rock Shaft.....
58234	—	Feed Rock Shaft complete, Nos. 58233 and 58235.....
58235	4491	Feed Rock Shaft Crank with 346E.....
346E	4453	" " " Clamping Screw.
564c	898	" " " Screw Center.....
58384	—	" " " " " 564c with 1508J.....
1508J	890	Feed Rock Shaft Screw Center Nut.....
26419	4417	Guide (6 in. face).....
885D	902	" Thumb Screw.....
58236	4493	Lifting Presser Bar.....
11523	856	" " " Bell Crank.....
11524	—	" " " " " Adjusting Link.....
11525	856	Lifting Presser Bar Bell Crank Adjusting Link complete, Nos. 1518J, 1828, 2718 and 11524.....
1828	899	Lifting Presser Bar Bell Crank Adjusting Link Roller with 372c.....

72 PARTS FOR MACHINE No. 7-22

NO.	PLATE	NAME
372c	898	Lifting Presser Bar Bell Crank Adjusting Link Roller Screw.....
1518j	907	Lifting Presser Bar Bell Crank Adjusting Link Roller Screw Nut.....
2718	897	Lifting Presser Bar Bell Crank Adjusting Link Roller Screw Nut Washer.....
611c	905	Lifting Presser Bar Bell Crank Adjusting Link Screw.....
11526	889	Lifting Presser Bar Bell Crank Connecting Stud with two 858c.....
11527	—	Lifting Presser Bar Bell Crank Connecting Stud complete, Nos. 164E, 11526 and 11528.....
164E	899	Lifting Presser Bar Bell Crank Connecting Stud Cap Screw.....
11528	862	Lifting Presser Bar Bell Crank Connecting Stud Cap Screw Washer.....
858c	900	Lifting Presser Bar Bell Crank Connecting Stud Set Screw.....
51260D	9619	Lifting Presser Bar Bell Crank Hinge Screw.....
51609E	9620	Lifting Presser Bar Bell Crank Hinge Screw Nut.....
11867	857	Lifting Presser Bar Lifter.....
58237	4491	" " " " Bracket with 1497F and 58238.....
1497F	4491	Lifting Presser Bar Lifter Bracket Set Screw.....
58238	4491	Lifting Presser Bar Lifter Bracket Spring Bearing.....
19866	862	Lifting Presser Bar Lifter Hinge Pin.....
910c	900	" " " " " " " " Set Screw.....
11031	863	Lifting Presser Bar Spring (flat).....
58252	4493	" " " " " " Bracket.....
1177E	4494	" " " " " " " " Screw
11661	9608	" " " " " " Guide Pin.....
50323D	4489	" " " " " " Regulating Thumb Screw.....
19732	911	Needle Bar.....
19735	—	Needle Bar complete, with adjustable clamps, Nos. 19732 to 19734 and two 898E.....
*19564	869	Needle Bar Connecting Link.....
566c	898	" " " " " " Hinge Screw
1513j	890	" " " " " " " " Nut.....

PARTS FOR MACHINE No. 7-22 73

NO.	PLATE	NAME
19565	869	Needle Bar Connecting Stud with 129E and 445F.....
58203	—	Needle Bar Connecting Stud 19565 with 19564.....
129E	901	Needle Bar Connecting Stud Clamping Screw.....
445F	900	Needle Bar Connecting Stud Set Screw...
257E	902	" " " " Screw Bushing.....
19733	914	" " " " Clamp (left) with 191F.....
19734	914	" " " " (right) with 191F.....
898E	901	" " " " " " Screw.....
191F	899	" " " " " " Set Screw.....
58253	—	Oil Cup.....
11917	825	" " " " Cover.....
9084	889	" " " " " " Hinge Pin.....
2205	887	" " " " " " Latch Spring.....
207F	901	" " " " " " " " Screw.....
8953	874	" " or Wax Stripper (felt).....
11918	888	" " " " " " Washer (steel) for 11917.....
8482	890	Oil or Wax Stripper Washer (steel) for 58253.....
207F	901	Oil or Wax Stripper Washer Screw.....
58254	4490	Oil Cup complete, Nos. 2205, 8482, 9084, 11917, 11918, 58253, two 8953 and three 207F.....
134E	900	Oil Cup Screw.....
58573	9625	Oscillating Rock Shaft.....
58566	—	Oscillating Rock Shaft complete, Nos. 1508j, 11165, 51237c, 58570, 58573 and 58586.....
58585	9625	Oscillating Rock Shaft Hinge Pin.....
58586	—	" " " " " " " " 5 8 5 8 5 with 1508j.....
1508j	890	Oscillating Rock Shaft Hinge Pin Nut....
51237c	9619	" " " " " " " " Screw Bearing.....
1508j	890	Oscillating Rock Shaft Hinge Pin Screw Bearing Nut.....
11165	897	Oscillating Rock Shaft Oil Pad.....
58567	—	" " " " " " Tube with 58569.....
58570	9616	Oscillating Rock Shaft Oil Tube complete, Nos. 58567, 58568 and 127848.....
58568	9616	Oscillating Rock Shaft Oil Tube Joint....
127848	9608	" " " " " " Oil Cup.
*58569	—	" " " " " " Sleeve...

NO.	PLATE	NAME
19567	863	Oscillating Shaft.....
11848	—	“ “ Crank.....
19696	4421	Oscillating Shaft Crank complete, Nos. 453c, 1513j, 5868 and 11848.....
40025	4492	Oscillating Shaft Crank Pin.....
453c	899	“ “ “ Set Screw.....
9119	4421	“ “ “ Slide Block.....
5868	4421	Oscillating Shaft Crank Slide Block com- plete, Nos. 190E, 1054c, 5968 and 9119
190E	899	Oscillating Shaft Crank Slide Block Cap Screw.....
5968	887	Oscillating Shaft Crank Slide Block Cap Screw Washer.....
1054c	4421	Oscillating Shaft Crank Slide Block Screw Stud.....
1513j	890	Oscillating Shaft Crank Slide Block Screw Stud Nut.....
11910	833	Shuttle (inside) Bobbin.....
58512	9611	“ “ Cylinder.....
58513	—	“ “ “ 58512 with 774F and 58515.....
8961	833	Shuttle (inside) Cylinder Hinge Pin.....
58979	9611	“ “ “ Latch.....
12002	833	“ “ “ “ Pin.....
11854	833	“ “ “ “ Spring....
590D	901	“ “ “ “ “ Screw
19573	9614	“ “ “ Frame.....
58514	—	“ “ “ 19573 with 590D, 11854, 12002 and 58979.....
774F	4494	Shuttle (inside) Tension Regulating Screw
58515	9611	“ “ “ Spring.....
58516	9611	Shuttle (cylinder) inside, 3 in. diam., complete, Nos. 8961, 11910, 58513 and 58514.....
11910	833	Shuttle (outside) Bobbin.....
58517	9615	“ “ “ Cylinder.....
58518	—	“ “ “ 58517 with 774F and 58520.....
8961	833	Shuttle (outside) Cylinder Hinge Pin.....
58979	9611	“ “ “ “ Latch.....
12002	833	“ “ “ “ Pin.....
11854	833	“ “ “ “ Spring....
590D	901	“ “ “ “ “ Screw
19574	9614	“ “ “ Frame.....
58519	—	“ “ “ 19574 with 590D, 11854, 12002 and 58979.....

NO.	PLATE	NAME
774F	4494	Shuttle (outside) Tension Regulating Screw.....
58520	9615	Shuttle (outside) Tension Spring.....
58521	9615	Shuttle (cylinder) outside, 3 in. diam., complete, Nos. 8961, 11910, 58518 and 58519.....
19572	864	Shuttle Driver with 445c.....
8873	887	“ “ Pin.....
445c	900	“ “ Set Screw.....
19575	864	“ Race Back (inside).....
19576	864	“ “ “ (outside).....
11833	889	“ “ “ Position Pin.....
19577	864	“ “ “ Spring.....
32D	901	“ “ “ “ Screw.....
19578	864	“ “ “ Body.....
19579	—	Shuttle Race complete, Nos. 19575, 19576, 19578, two each 32D, 19577 and four 11833.....
58277	4492	Shuttle Race Dowel Pin.....
123E	901	“ “ Screw.....
11241	858	Tension Friction Washer (cloth) large....
8879	887	“ “ “ “ small..
19684	913	“ “ “ “ (steel).....
1535E	903	“ Regulating Thumb Nut.....
8787	890	“ “ “ “ Washer
709E	4451	Tension Screw Stud.....
58593	—	“ “ “ 709E with 1535E....
19685	913	“ “ “ Flange.....
19686	913	“ Spring.....
58795	4499	“ Wheel.....
19701	—	Tension (wheel) complete, Nos. 8787, 11241, 19684 to 19686, 58593 and two each 8879 and 58795.....
19584	869	Thread Eyelet (double) top of arm.....
166E	899	“ “ Screw.....
19585	869	“ Retaining Bracket.....
180E	901	“ “ “ Screw.....
2102	888	“ “ Disc.....
1560c	903	“ “ Regulating Thumb Nut
8905	887	“ “ “ “ “ Washer.....
633E	862	Thread Retaining Screw Stud.....
58592	—	“ “ “ “ 633E with 1560c.....
6312	862	Thread Retaining Screw Stud Washer....
2103	888	“ “ Spring.....
19586	865	“ “ Thread Guide Pin.....

NO.	PLATE	NAME
19587	—	Thread Retainer complete, Nos. 19585, 19586, two each 2103, 6312, 8905, 58592, and four 2102.....
11428	827	Thread Take-up Cam with two 434c.....
8873	887	" " " Pin.....
434c	899	" " " Set Screw.....
58319	4492	" " " Washer.....
58301	—	" " " Lever.....
58302	7815	" " " 58301 with 1995...
58316	—	" " " 58302 with 50437D
50437D	4494	" " " Hinge Screw.....
1995	4452	" " " Roller and Screw Stud with 1518j.....
1518j	907	Thread Take-up Lever Roller and Screw Stud Nut.....
58579	9626	Thread Take-up Spring (.083 in. wire) for general work.....
58580	9626	Thread Take-up Spring (.095 in. wire) for extra heavy work.....
11875	857	Thread Take-up Spring Regulator.....
164E	899	" " " " Screw..
164E	899	" " " " Screw.....
41544	4415	" " " " Washer....
19886	889	" " " " Thread Guard....
19591	—	Throat Plate Body.....
19997	—	" " " Needle Hole Strip (left)....
19592	868	" " " " " (right)....
401D	899	" " " " " Screw....
19593	868	Throat Plate complete, for 58328, Nos. 19591, 19592, 19997 and four 401D.....
381D	899	Throat Plate Screw.....
*15404	—	Trade Mark.....
15405	4492	" " Rivet.....
19594	4427	Vibrating Presser Bar.....
11560	4433	" " " " Cap Bracket (lower)
11559	4433	" " " " " (upper)
612E	901	" " " " " Screw (long).....
128E	901	Vibrating Presser Bar Cap Bracket Screw (short).....
58239	4491	Vibrating Presser Bar Guide Bracket with 874E and 1497F.....
1497F	4491	Vibrating Presser Bar Guide Bracket Set Screw.....
681D	862	Vibrating Presser Bar Hinge Screw.....
11563	862	" " " " Spring Stud with 19877.....

NO.	PLATE	NAME
19877	890	Vibrating Presser Bar Spring Stud Pin...
190E	899	" " " " " Screw.
11564	862	" " " " " Spring
58240	4491	" " " " " Stop Block.....
682D	862	" " " " " Thumb Screw.....
6312	862	Vibrating Presser Bar Stop Block Thumb Screw Washer.....
874E	4491	Vibrating Presser Bar Stop Block Stop Screw.....
19595	884	Vibrating Presser Foot.....
690E	4451	" " " " " Screw.....
1654c	903	" " " " " Nut.....

Genuine Singer Needles should be used in Singer Machines. These Needles and their Containers are marked with the Company's Trade Mark "SIMANCO." 1

Needles in Containers marked "For Singer Machines" are not Singer made needles. 2

LIST OF PARTS COMPLETE
FOR
MACHINE No. 7-24

FOR BUFF WHEELS NOT MORE THAN $\frac{3}{8}$ INCH THICK, WITH ATTACHMENT FOR MAKING CIRCULAR ROWS OF STITCHES $\frac{5}{16}$ INCH TO $\frac{1}{2}$ INCH APART AS ORDERED, AND AUTOMATICALLY CHANGING FROM EACH FINISHED ROW TO THE BEGINNING OF THE NEXT.

(OBSOLETE)

NO.	PLATE	NAME
*19555	—	Arm with 11559, 11560, 15404 and two each 128E, 612E and 15405.....
8702	887	Arm Dowel Pin.....
50348E	9619	" Screw.....
11878	838	" Shaft for 11945.....
58329	4495	" " " 58379.....
11354	830	" " Bushing.....
437C	899	" " " Set Screw.....
949E	4494	" " Screw for 58329.....
9842	4492	" " " Washer.....
11913	825	" Side Cover.....
65D	899	" " " Hinge Screw.....
8708	827	" Spool Pin.....
11241	858	" " " Washer (cloth).....
58407	9631	Balance Wheel and Pulley (tight) with two 354c, for 11945.....
122301	—	Balance Wheel with two 354c.....
122302	4496	" " 122301 with 11442, 122469, two 1402E and four 401E, for 19664.....
25362	9621	Balance Wheel Ball, size $\frac{3}{16}$ in.....
122303	—	" " " Ring.....
122304	4493	" " " " 122303 with eighteen 25362.....
122306	4493	Balance Wheel Ball Washer (left).....
122469	9616	" " " " (right).....
1402E	4494	" " " " " Screw.....
11442	896	" " Friction Washer (paper).....
401E	899	" " " " Screw.....
354C	899	" " " Set Screw.....
*19597	—	Bed.....
*19598	—	" Extension with 19633.....
8873	887	" " Dowel Pin.....
123E	901	" " Screw.....

NO.	PLATE	NAME
19599	876	Buff Wheel Clamp Carrier with 19614....
19600	878	" " " " Cap.....
12596	879	" " " " Pin.....
691F	905	" " " " Screw....
19601	876	" " " " Locking Rack with 19614.....
19602	876	Buff Wheel Clamp Carrier Locking Rack Bracket with two 453c.....
19603	878	Buff Wheel Clamp Carrier Locking Rack Bracket Hinge Pin.....
2022	887	Buff Wheel Clamp Carrier Locking Rack Bracket Hinge Pin Dowel Pin.....
453c	899	Buff Wheel Clamp Carrier Locking Rack Bracket Hinge Pin Set Screw.....
19604	—	Buff Wheel Clamp Carrier Locking Rack Bracket Latch complete, Nos. 19605 to 19608.....
19605	877	Buff Wheel Clamp Carrier Locking Rack Bracket Latch Body with 453c.....
2022	887	Buff Wheel Clamp Carrier Locking Rack Bracket Latch Body Pin.....
453c	899	Buff Wheel Clamp Carrier Locking Rack Bracket Latch Body Set Screw.....
19606	880	Buff Wheel Clamp Carrier Locking Rack Bracket Latch Pin.....
19607	880	Buff Wheel Clamp Carrier Locking Rack Bracket Latch Pin Head.....
19608	879	Buff Wheel Clamp Carrier Locking Rack Bracket Latch Spring.....
381E	899	Buff Wheel Clamp Carrier Locking Rack Screw.....
19609	881	Buff Wheel Clamp Carrier Sliding Flange with 453c.....
19611	880	Buff Wheel Clamp Carrier Sliding Flange Gear with 462c.....
2049	853	Buff Wheel Clamp Carrier Sliding Flange Gear Pin.....
462c	4451	Buff Wheel Clamp Carrier Sliding Flange Gear Set Screw.....
2049	853	Buff Wheel Clamp Carrier Sliding Flange Pin.....
453c	899	Buff Wheel Clamp Carrier Sliding Flange Set Screw.....
19610	880	Buff Wheel Clamp Carrier Sliding Flange Shaft.....
19612	876	Buff Wheel Clamp Carrier Sliding Rack with 19613.....

NO.	PLATE	NAME
685E	905	Buff Wheel Clamp Carrier Sliding Rack Screw.....
8734	886	Buff Wheel Clamp Carrier Sliding Rack Spring.....
19613	879	Buff Wheel Clamp Carrier Sliding Rack Spring Hook for 19612.....
19614	879	Buff Wheel Clamp Carrier Sliding Rack Spring Hook for 19601.....
792C	903	Buff Wheel Clamp Carrier Sliding Rack Stop Screw.....
19615	880	Buff Wheel Clamp Carrier Stop.....
19616	878	" " " " " Plate.....
691F	905	" " " " " Screw
164E	899	" " " " " Screw.....
19617	878	" " " " " Weight (3¼ lbs.) with 19624 and 19625.....
19618	878	Buff Wheel Clamp Carrier Weight (4½ lbs.) with 19624 and 19625.....
19619	—	Buff Wheel Clamp Carrier Weight Connection (belt) with 19621.....
19620	879	Buff Wheel Clamp Carrier Weight Connection Guide Pin.....
19621	904	Buff Wheel Clamp Carrier Weight Connection Hook for 19619.....
19614	879	Buff Wheel Clamp Carrier Weight Connection Hook for 19599.....
19622	881	Buff Wheel Clamp Carrier Weight Connection Pulley.....
19623	880	Buff Wheel Clamp Carrier Weight Connection Pulley Bracket.....
164E	899	Buff Wheel Clamp Carrier Weight Connection Pulley Bracket Screw.....
917D	900	Buff Wheel Clamp Carrier Weight Connection Pulley Screw.....
19624	881	Buff Wheel Clamp Carrier Weight Eyelet
19625	881	" " " " " " "
		Hook.....
19626	880	Buff Wheel Clamp Spindle with three 19627.....
19611	880	Buff Wheel Clamp Spindle Gear with 462c.....
2049	853	Buff Wheel Clamp Spindle Gear Pin.....
462C	4451	" " " " " Set Screw
19627	879	" " " " " Spur.....
50201F	4453	" " " " " Thumb Screw.....
19628	880	" " " " " Washer.....
19629	4430	Cloth Plate.....

NO.	PLATE	NAME
389F	901	Cloth Plate Screw.....
11363	825	Crank Connecting Rod.....
565c	898	" " " " " Hinge Screw.....
1513J	890	" " " " " " " Nut
58214	4495	Face Plate.....
58215	—	Face Plate complete, Nos. 190E, 910c, 11867, 11871, 11872, 11875, 11876, 19866, 41544, 58214, 58522, 58581 or 58582 and two 164E.....
11872	861	Face Plate Thread Eyelet.....
58522	9608	" " " " " Guard.....
190E	899	" " " " " Screw.....
161E	901	" " " " " Screw.....
19630	877	Feed Bar.....
307c	898	" " " " " Screw Center.....
56814	—	" " " " " 307c with 1513J..
1513J	890	" " " " " Nut.....
11367	830	" Cam with two 445c.....
445c	900	" Set Screw.....
11368	830	" Connecting Link.....
565c	898	" " " " " Hinge Screw.....
1513J	890	" " " " " " " Nut..
19631	879	" Dog, 5 teeth (10 teeth to the inch) for 19643.....
19632	877	Feed Dog Carrier with 8077.....
568C	898	" " " " " Hinge Screw.....
8734	886	" " " " " Spring.....
8077	879	" " " " " Hook for 19632.
19633	879	" " " " " " " 19598.
919C	900	" " " " " Screw.....
11370	825	" Forked Connection.....
565E	898	" " " " " Hinge Screw....
1513J	890	" " " " " " " Nut
19970	4420	" Lifting Rock Shaft with 134E, 2022 and 19967.....
19972	—	Feed Lifting Rock Shaft complete, Nos. 19816 and 19970.....
19816	4439	Feed Lifting Rock Shaft Crank with 346E, 1513J and 1885.....
346E	4453	Feed Lifting Rock Shaft Crank Clamping Screw.....
1885	900	Feed Lifting Rock Shaft Crank Roller with 190E, 1054c and 5968.....
190E	899	Feed Lifting Rock Shaft Crank Roller Cap Screw.....
5968	887	Feed Lifting Rock Shaft Crank Roller Cap Screw Washer.....

NO.	PLATE	NAME
1054c	4421	Feed Lifting Rock Shaft Crank Roller Screw Stud.....
1513j	890	Feed Lifting Rock Shaft Crank Roller Screw Stud Nut.....
564c	898	Feed Lifting Rock Shaft Screw Center
58384	—	“ “ “ “ “ “
		564c with 1508j.....
1508j	890	Feed Lifting Rock Shaft Screw Center Nut.....
19967	861	Feed Lifting Rock Shaft Wearing Block
2022	887	“ “ “ “ “ “
		Position Pin.....
134E	900	Feed Lifting Rock Shaft Wearing Block Screw.....
11375	830	Feed Regulator.....
568E	898	“ “ Hinge Screw.....
50322D	4489	“ “ Thumb Screw.....
58233	4490	“ Rock Shaft.....
58234	—	Feed Rock Shaft complete, Nos. 58233 and 58235.....
58235	4491	Feed Rock Shaft Crank with 346E.....
346E	4453	“ “ “ Clamping Screw.....
564c	898	“ “ “ Screw Center.....
58384	—	“ “ “ “ “ 564c with 1508j.....
1508j	890	Feed Rock Shaft Screw Center Nut.....
19634	880	Guide Pin, for circular stitching.....
19635	876	“ Plate, for circular stitching.....
NOTE: When ordering 19635 state distance between rows of stitching.		
691F	905	Guide Plate Screw.....
11522	855	Lifting Presser Bar.....
11523	856	“ “ “ Bell Crank.....
11524	—	“ “ “ “ “ Adjusting Link.....
11525	856	Lifting Presser Bar Bell Crank Adjusting Link complete, Nos. 1518j, 1828, 2718 and 11524.....
1828	899	Lifting Presser Bar Bell Crank Adjusting Link Roller with 372c.....
372c	898	Lifting Presser Bar Bell Crank Adjusting Link Roller Screw.....
1518j	907	Lifting Presser Bar Bell Crank Adjusting Link Roller Screw Nut.....
2718	897	Lifting Presser Bar Bell Crank Adjusting Link Roller Screw Nut Washer.....

NO.	PLATE	NAME
611c	905	Lifting Presser Bar Bell Crank Adjusting Link Screw.....
11526	889	Lifting Presser Bar Bell Crank Connecting Stud with two 858c.....
11527	—	Lifting Presser Bar Bell Crank Connecting Stud complete, Nos. 164E, 11526 and 11528.....
164E	899	Lifting Presser Bar Bell Crank Connecting Stud Cap Screw.....
11528	862	Lifting Presser Bar Bell Crank Connecting Stud Cap Screw Washer.....
858c	900	Lifting Presser Bar Bell Crank Connecting Stud Set Screw.....
8D	898	Lifting Presser Bar Bell Crank Hinge Screw.....
11867	857	Lifting Presser Bar Lifter.....
11531	881	“ “ “ “ Bracket.....
2117	890	“ “ “ “ Pin....
19866	862	“ “ “ “ Hinge Pin....
910c	900	“ “ “ “ “ “ S e t Screw.....
11409	827	Lifting Presser Bar Spring.....
11869	860	“ “ “ “ Adjusting Block with 523c.....
523c	901	Lifting Presser Bar Spring Adjusting Block Set Screw.....
11380	828	Needle Bar.....
*11539	856	“ “ Connecting Link.....
566c	898	“ “ “ “ Hinge Screw
1513j	890	“ “ “ “ “ “
		Nut.....
11383	887	Needle Bar Connecting Stud with two 445F.....
19981	—	Needle Bar Connecting Stud 11383 with 11539.....
445F	900	Needle Bar Connecting Stud Set Screw...
258E	899	“ “ Screw Bushing.....
19702	890	“ Clamp with 680F and 11385.....
*11385	890	“ “ Gib.....
680F	862	“ “ Thumb Screw.....
11497	825	Oil Cup.....
11917	825	“ “ Cover.....
9084	889	“ “ “ Hinge Pin.....
2205	887	“ “ “ Latch Spring.....
207F	901	“ “ “ “ “ Screw.....
8953	874	“ or Wax Stripper (felt).....

NO.	PLATE	NAME
11918	888	Oil or Wax Stripper Washer (steel) for 11917.....
8482	890	Oil or Wax Stripper Washer (steel) for 11497.....
207F	901	Oil or Wax Stripper Washer Screw.....
11921	825	Oil Cup complete, Nos. 2205, 8482, 9084, 11497, 11917, 11918, two 8953 and three 207F.....
134E	900	Oil Cup Screw.....
11841	827	Oscillating Rock Shaft.....
11842	—	Oscillating Rock Shaft complete, Nos. 622c, 1508j, 11165, 11841 and 58293....
11398	827	Oscillating Rock Shaft Hinge Pin.....
58293	—	“ “ “ “ “ 11398 with 1508J.....
1508J	890	Oscillating Rock Shaft Hinge Pin Nut....
622c	899	“ “ “ “ “ Screw Bearing.....
1508J	890	Oscillating Rock Shaft Hinge Pin Screw Bearing Nut.....
11165	897	Oscillating Rock Shaft Oil Pad.....
11850	825	“ Shaft.....
11393	887	“ “ Collar with two 453c....
453c	899	“ “ “ Set Screw.....
11848	—	“ “ Crank.....
19696	4421	Oscillating Shaft Crank complete, Nos. 453c, 1513j, 5868 and 11848.....
40025	4492	Oscillating Shaft Crank Pin.....
453c	899	“ “ “ Set Screw.....
9119	4421	“ “ “ Slide Block.....
5868	4421	Oscillating Shaft Crank Slide Block complete, Nos. 190E, 1054c, 5968 and 9119.
190E	899	Oscillating Shaft Crank Slide Block Cap Screw.....
5968	887	Oscillating Shaft Crank Slide Block Cap Screw Washer.....
1054c	4421	Oscillating Shaft Crank Slide Block Screw Stud.....
1513J	890	Oscillating Shaft Crank Slide Block Screw Stud Nut.....
11910	7268	Shuttle Bobbin.....
11852	833	“ Cylinder.....
*19986	—	“ “ 11852 with 773F and 8964.....
8961	833	Shuttle Cylinder Hinge Pin.....
11853	833	“ “ Latch.....
12002	833	“ “ “ Pin.....

NO.	PLATE	NAME
11854	833	Shuttle Cylinder Latch Spring.....
590D	901	“ “ “ “ Screw.....
19637	881	“ Frame.....
58294	—	“ “ 19637 with 590D, 11853, 11854 and 12002.....
773F	7268	Shuttle Tension Regulating Screw.....
8964	833	“ “ Spring.....
19636	4429	Shuttle (cylinder) 3 in. diam., complete, Nos. 8961, 11910, 19986 and 58294.....
11856	830	Shuttle Driver with 453c.....
2117	890	“ “ Pin.....
453c	899	“ “ Set Screw.....
19638	877	“ Race Back.....
11833	889	“ “ “ Position Pin.....
19577	864	“ “ “ Spring.....
32D	901	“ “ “ Screw.....
19639	877	“ “ Body.....
19640	—	Shuttle Race complete, Nos. 32D, 19577, 19638, 19639 and two 11833.....
134E	900	Shuttle Race Screw.....
11837	825	“ “ Frame with 11838.....
670E	862	“ “ “ Clamping Screw.....
11838	889	“ “ “ Position Pin.....
8879	887	Tension Friction Washer (cloth).....
11043	897	“ “ “ (steel).....
1560c	903	“ Regulating Thumb Nut.....
8905	887	“ “ “ “ Washer
850E	902	“ Screw Stud.....
58591	—	“ “ “ 850E with 1560c....
8791	888	“ Spring.....
11044	897	“ Wheel.....
11871	—	Tension (wheel) complete, Nos. 8791, 8905, 11043, 11044, 58591 and two 8879
11547	859	Thread Retaining Bracket.....
158E	901	“ “ “ Screw.....
2102	888	“ “ Disc.....
1560c	903	“ “ Regulating Thumb Nut
8905	887	“ “ “ “ Washer.....
633E	862	Thread Retaining Screw Stud.....
58592	—	“ “ “ “ 633E with 1560c.....
2103	888	Thread Retaining Spring.....
2049	853	“ “ Thread Guide Pin.....
11546	—	Thread Retainer complete, Nos. 2049, 2103, 8905, 11547, 58592 and two 2102

NO.	PLATE	NAME
11428	827	Thread Take-up Cam with two 434c.....
8873	887	" " " Pin.....
434c	899	" " " Set Screw.....
58295	—	" " " Lever.....
58296	4493	" " " 58295 with 1995...
58320	—	" " " 58296 with 50437D
50437D	4494	" " " Hinge Screw.....
1995	4452	" " " Roller and Screw Stud with 1518j.....
1518j	907	Thread Take-up Lever Roller and Screw Stud Nut.....
58581	9626	Thread Take-up Spring (.083 in. wire) for general work.....
58582	9626	Thread Take-up Spring (.095 in. wire) for extra heavy work.....
11875	857	Thread Take-up Spring Regulator.....
164j	899	" " " " " Screw
164j	899	" " " " " Screw.....
41544	4415	" " " " " Washer....
11876	860	" " " " " Thread Guard....
19641	—	Throat Plate Body with 19620.....
19642	879	" " " Needle Hole Strip.....
401D	899	" " " " " " Screw....
19643	879	Throat Plate complete for 19631, Nos. 19641, 19642 and two 401D.....
381D	899	Throat Plate Screw.....
*15404	—	Trade Mark.....
15405	4492	" " " Rivet.....
19644	876	Vibrating Presser Bar.....
11560	4433	" " " Cap Bracket (lower).....
11559	4433	Vibrating Presser Bar Cap Bracket (upper).....
612E	901	Vibrating Presser Bar Cap Bracket Screw (long).....
128E	901	Vibrating Presser Bar Cap Bracket Screw (short).....
11561	859	Vibrating Presser Bar Guide Bracket.....
2049	853	" " " " " " Pin
681D	862	" " " " " Hinge Screw.....
11563	862	" " " " " Spring Stud with 19877.....
19877	—
19877	890	Vibrating Presser Bar Spring Stud Pin....
190E	899	" " " " " " Screw.
11564	862	" " " " " " Spring
11565	859	Vibrating Presser Bar Stop complete, Nos. 682D, 6312, 11566 and 11567.....

NO.	PLATE	NAME
11566	862	Vibrating Presser Bar Stop Block.....
6312	862	" " " " " Washer (large).....
11567	862	Vibrating Presser Bar Stop Block Washer (small).....
682D	862	Vibrating Presser Bar Stop Thumb Screw
19645	879	" " " and Stretching Foot....
657c	903	" " " " " "Hinge Screw.....
1620E	903	Vibrating Presser and Stretching Foot Hinge Screw Nut.....
25837	904	Vibrating Presser and Stretching Foot Spring.....
19647	879	Vibrating Presser and Stretching Foot Spring Stud.....
212c	903	Vibrating Presser and Stretching Foot Stop Screw.....

Genuine Singer Needles should be used in Singer Machines. These Needles and their Containers are marked with the Company's Trade Mark "SIMANCO." 1

Needles in Containers marked "For Singer Machines" are not Singer made needles. 2

**LIST OF PARTS COMPLETE
FOR
MACHINE No. 7-26**

HAS TWO NEEDLES, TWO CYLINDER SHUTTLES, NOS. 43275 AND 43283, GAUGE 1 INCH. CAN BE FURNISHED FROM 1 INCH UP TO 1½ INCH GAUGE AT AN ADDITION OF \$45.00 TO THE REGULAR SELLING PRICE OF THE MACHINE. HAS DROP FEED, ADJUSTABLE PRESSER, EITHER VIBRATING OR STATIONARY AND BELT SHIFTER.

NO.	PLATE	NAME
*19963	—	Arm with 11559, 15404, 19888 and two each 128E, 612E and 15405.....
19785	914	Arm Dowel Pin.....
*19887	—	“ Packing Plate.....
68350	9608	“ Oil Cup, for oiling Arm Shaft Front and Back Bearings.....
58548	9608	Arm Oil Tube, for oiling Arm Shaft Intermediate Bearing.....
50347E	4489	Arm Screw.....
43263	4492	“ “ Washer.....
19747	4430	“ Shaft.....
11354	830	“ “ Bushing.....
437C	899	“ “ “ Set Screw.....
11913	825	“ Side Cover.....
65D	899	“ “ “ Hinge Screw.....
19991	4496	Balance Wheel and Pulley (tight) with two 354c.....
354c	899	Balance Wheel Set Screw.....
*19756	—	Bed.....
24131	9608	“ Oil Tube with 52045, for oiling Feed Rock Shaft (back) Bearing.....
58549	9608	Bed Oil Tube with 52045, for oiling Feed Lifting and Feed Rock Shaft (front) Bearings.....
52045	9608	Bed Oil Tube Packing (felt).....
19757	916	Cloth Plate.....
145F	899	“ “ Screw.....
19758	4403	Crank Connecting Rod.....
1151c	4452	“ “ “ Hinge Screw.....
1646J	903	“ “ “ “ “ Nut.....
58216	4497	Face Plate.....

NO.	PLATE	NAME
58217	—	Face Plate complete, Nos. 910c, 11867, 11875, 19590, 19701, 19866, 19886, 41544, 58216, 58466, 58579 or 58580 and three 164E.....
58466	9608	Face Plate Thread Eyelet.....
19590	865	“ “ “ Guard.....
164E	899	“ “ “ “ Screw.....
161E	901	“ “ Screw.....
19760	4404	Feed Bar.....
307C	898	“ “ Screw Center.....
56814	—	“ “ “ “ 307c with 1513J.....
1513J	890	“ “ “ “ Nut.....
11367	830	“ Cam with two 445c.....
445C	900	“ “ Set Screw.....
11368	830	“ Connecting Link.....
565C	898	“ “ “ Hinge Screw.....
1513J	890	“ “ “ “ “ Nut.....
19761	9609	“ Dog, 13 teeth (10 teeth to the inch) for 58440.....
381E	899	Feed Dog Screw.....
19762	4403	“ Forked Connection.....
565C	898	“ “ “ Hinge Screw.....
1513J	890	“ “ “ “ “ Nut.....
58346	7835	“ Lifting Rock Shaft with 134E, 2022 and 19967.....
58347	—	Feed Lifting Rock Shaft complete, Nos. 19819 and 58346.....
19819	4439	Feed Lifting Rock Shaft Crank with 346E and 1861.....
346E	4453	Feed Lifting Rock Shaft Crank Clamping Screw.....
1861	862	Feed Lifting Rock Shaft Crank Roller and Stud.....
294C	4453	Feed Lifting Rock Shaft Screw Center.....
58594	—	“ “ “ “ “ “ “ “ 294c with 1503J.....
1503J	903	Feed Lifting Rock Shaft Screw Center Nut.....
19967	861	Feed Lifting Rock Shaft Wearing Block.....
2022	887	“ “ “ “ “ “ “ “ Position Pin.....
134E	900	Feed Lifting Rock Shaft Wearing Block Screw.....
11375	830	Feed Regulator.....
568E	898	“ “ Hinge Screw.....
50322D	4489	“ “ Thumb Screw.....
58321	4490	“ Rock Shaft.....

NO.	PLATE	NAME
58322	---	Feed Rock Shaft complete, Nos. 58235 and 58321.....
58235	4491	Feed Rock Shaft Crank with 346E.....
346E	4453	" " " " Clamping Screw.....
294C	4453	" " " " Screw Center.....
58594	---	" " " " " 294c with 1503J.....
1503J	903	Feed Rock Shaft Screw Center Nut.....
26176	847	Guide (6 in. face).....
885D	902	" Thumb Screw.....
58236	4493	Lifting Presser Bar.....
11523	856	" " " " Bell Crank.....
11524	---	" " " " " Adjusting Link.....
11525	856	Lifting Presser Bar Bell Crank Adjusting Link complete, Nos. 1518J, 1828, 2718 and 11524.....
1828	899	Lifting Presser Bar Bell Crank Adjusting Link Roller with 372c.....
372c	898	Lifting Presser Bar Bell Crank Adjusting Link Roller Screw.....
1518J	907	Lifting Presser Bar Bell Crank Adjusting Link Roller Screw Nut.....
2718	897	Lifting Presser Bar Bell Crank Adjusting Link Roller Screw Nut Washer.....
611c	905	Lifting Presser Bar Bell Crank Adjusting Link Screw.....
11526	889	Lifting Presser Bar Bell Crank Connecting Stud with two 858c.....
11527	---	Lifting Presser Bar Bell Crank Connecting Stud complete, Nos. 164E, 11526 and 11528.....
164E	899	Lifting Presser Bar Bell Crank Connecting Stud Cap Screw.....
11528	862	Lifting Presser Bar Bell Crank Connecting Stud Cap Screw Washer.....
858c	900	Lifting Presser Bar Bell Crank Connecting Stud Set Screw.....
51260D	9619	Lifting Presser Bar Bell Crank Hinge Screw.....
51609E	9620	Lifting Presser Bar Bell Crank Hinge Screw Nut.....
11867	857	Lifting Presser Bar Lifter.....
58237	4491	" " " " Bracket with 1497F and 58238.....
1497F	4491	Lifting Presser Bar Lifter Bracket Set Screw.....

NO.	PLATE	NAME
58238	4491	Lifting Presser Bar Lifter Bracket Spring Bearing.....
19866	862	Lifting Presser Bar Lifter Hinge Pin.....
910C	900	" " " " " " Set Screw.....
11031	863	Lifting Presser Bar Spring (flat).....
58252	4493	" " " " Bracket.....
1177E	4494	" " " " " Screw.....
11661	9608	" " " " Guide Pin.....
50323D	4489	" " " " Regulating Thumb Screw.....
19732	911	Needle Bar.....
19735	---	Needle Bar complete with adjustable clamps, for 1 in. to 1½ in. gauges, Nos. 19732 to 19734 and two 898E.....
*19564	869	Needle Bar Connecting Link.....
566c	898	" " " " Hinge Screw.....
1513J	890	" " " " " " Nut.....
19565	869	Needle Bar Connecting Stud with 129E and 445F.....
58203	---	Needle Bar Connecting Stud 19565 with 19564.....
129E	901	Needle Bar Connecting Stud Clamping Screw.....
445F	900	Needle Bar Connecting Stud Set Screw...
257E	902	" " Screw Bushing.....
19733	914	" Clamp (left) with 191F.....
19734	914	" " (right) with 191F.....
898E	901	" " Screw.....
191F	899	" Set Screw.....
58253	---	Oil Cup.....
11917	825	" " Cover.....
9084	889	" " " Hinge Pin.....
2205	887	" " " Latch Spring.....
207F	901	" " " " Screw.....
8953	874	" or Wax Stripper (felt).....
11918	888	" " " " Washer (steel) for 11917.....
8482	890	Oil or Wax Stripper Washer (steel) for 58253.....
207F	901	Oil or Wax Stripper Washer Screw.....
58254	4490	Oil Cup complete, Nos. 2205, 8482, 9084, 11917, 11918, 58253, two 8953 and three 207F.....
134E	900	Oil Cup Screw.....
58550	9625	Oscillating Rock Shaft.....

NO.	PLATE	NAME
58551	—	Oscillating Rock Shaft complete, Nos. 1503j, 11165, 51227c, 58550, 58555 and 58595.
58552	9625	Oscillating Rock Shaft Hinge Pin.
58595	—	“ “ “ “ “ 5 8 5 5 2 with 1503j.
1503j	903	Oscillating Rock Shaft Hinge Pin Nut.
51227c	9619	“ “ “ “ “ Screw Bearing.
1503j	903	Oscillating Rock Shaft Hinge Pin Screw Bearing Nut.
11165	897	Oscillating Rock Shaft Oil Pad.
58553	—	“ “ “ “ Tube with 49191.
58555	9616	Oscillating Rock Shaft Oil Tube with Joint complete, Nos. 58553, 58554 and 68350.
58554	9616	Oscillating Rock Shaft Oil Tube Joint.
68350	9608	“ “ “ “ “ Oil Cup
*49191	—	“ “ “ “ “ Sleeve
19769	4402	“ Shaft.
19770	—	“ “ Crank with 445c.
19789	4406	Oscillating Shaft Crank complete, Nos. 1508j, 19770 and 19773.
8873	887	Oscillating Shaft Crank Pin.
445c	900	“ “ “ Set Screw.
19771	4406	“ “ “ Slide Block.
19773	4406	Oscillating Shaft Crank Slide Block complete, Nos. 164E, 1156c, 19771 and 19772.
164E	4406	Oscillating Shaft Crank Slide Block Cap Screw.
19772	4406	Oscillating Shaft Crank Slide Block Cap Screw Washer.
1156c	4406	Oscillating Shaft Crank Slide Block Screw Stud.
1508j	890	Oscillating Shaft Crank Slide Block Screw Stud Nut.
16901	9622	Shuttle (inside) Bobbin.
43273	7816	“ “ “ Center Pin.
43274	7817	“ “ “ Cylinder with 43273.
43286	—	“ “ “ 43274 with 1323F and 8895.
8777	9621	Shuttle (inside) Cylinder Hinge Pin.
43239	7816	“ “ “ Latch.
43236	7816	“ “ “ Hinge Pin
19869	4423	“ “ “ Spring.
43240	7817	“ “ “ Frame.

NO.	PLATE	NAME
43255	—	Shuttle (inside) Frame 43240 with 19869, 43236 and 43239.
8895	9622	Shuttle (inside) Tension Spring.
1323F	901	“ “ “ Regulating Screw
43275	7816	Shuttle (inside, cylinder) 4 in. diam., complete, Nos. 8777, 16901, 43255 and 43286.
16901	9622	Shuttle (outside) Bobbin.
43273	7816	“ “ “ Center Pin.
43282	7818	“ “ “ Cylinder with 43273.
43287	—	“ “ “ 43282 with 1323F and 8900.
8777	9621	Shuttle (outside) Cylinder Hinge Pin.
43235	7818	“ “ “ Latch.
43236	7816	“ “ “ Hinge Pin.
19869	4423	Shuttle (outside) Cylinder Latch Spring.
43242	7819	“ “ “ Frame.
43256	—	“ “ “ 43242 with 19869, 43235 and 43236.
1323F	901	Shuttle (outside) Tension Regulating Screw.
8900	9622	Shuttle (outside) Tension Spring.
43283	7818	Shuttle (outside, cylinder) 4 in. diam., complete, Nos. 8777, 16901, 43256 and 43287.
19774	4404	Shuttle Driver with 445c.
8055	860	“ “ Pin.
445c	900	“ “ Set Screw.
19775	—	“ Race Body.
19776	4408	“ “ Ring (inside).
19777	4408	“ “ “ (outside).
134E	900	“ “ “ Screw.
19778	4407	Shuttle Race complete, Nos. 19775 to 19777 and six 134E.
58277	4492	Shuttle Race Dowel Pin.
123E	901	“ “ Screw.
11241	858	Tension Friction Washer (cloth) large.
8879	887	“ “ “ “ small.
19684	913	“ “ “ (steel).
1535E	903	“ Regulating Thumb Nut.
8787	890	“ “ “ Washer
709E	4451	Tension Screw Stud.
58593	—	“ “ “ 709E with 1535E.
19685	913	“ “ “ Flange.
19686	913	“ Spring.
58795	4499	“ Wheel.

NO.	PLATE	NAME
19701	---	Tension (wheel) complete, Nos. 8787, 11241, 19684 to 19686, 58593 and two each 8879 and 58795.....
19584	869	Thread Eyelet (double) top of arm.....
166E	899	" " Screw.....
19585	869	" Retaining Bracket.....
180E	901	" " " Screw.....
2102	888	" " Disc.....
1560c	903	" " Regulating Thumb Nut
8905	887	" " " " "
		Washer.....
633E	862	Thread Retaining Screw Stud.....
58592	---	" " " " 633E with 1560c.....
6312	862	Thread Retaining Screw Stud Washer....
2103	888	" " Spring.....
19586	865	" " Thread Guide Pin.....
19587	---	Thread Retainer complete, Nos. 19585, 19586, two each 2103, 6312, 8905, 58592 and four 2102.....
11428	827	Thread Take-up Cam with two 434c.....
8873	887	" " " Pin.....
434c	899	" " " Set Screw.....
58319	4492	" " " Washer.....
58303	---	" " Lever with two 9219.....
58304	7815	" " " 58303 with 1995..
58312	---	" " " 58304 with 50437D
50437D	4494	" " " Hinge Screw.....
1995	4452	" " " Roller and Screw Stud with 1518r.....
1518r	907	Thread Take-up Lever Roller and Screw Stud Nut.....
9219	9621	Thread Take-up Lever Thread Eyelet Bushing.....
58579	9626	Thread Take-up Spring (.083 in. wire) for general work.....
58580	9626	Thread Take-up Spring (.095 in. wire) for extra heavy work.....
11875	857	Thread Take-up Spring Regulator.....
164E	899	" " " " Screw..
164E	899	" " " " Screw.....
41544	4415	" " " " Washer....
19886	889	" " " " Thread Guard....
58439	---	Throat Plate Body.....
58436	9609	" " Needle Hole Strip (left)....
58437	---	" " " " " (right)....
742D	9620	" " " " " Screw....

NO.	PLATE	NAME
58440	9609	Throat Plate complete for 19761, Nos. 58436, 58437, 58439 and four 742D....
381D	899	Throat Plate Screw.....
*15404	---	Trade Mark.....
15405	4492	" " Rivet.....
19784	4403	Vibrating Presser Bar.....
19888	858	" " " Cap Bracket (lower).....
11559	4433	Vibrating Presser Bar Cap Bracket (upper).....
612E	901	Vibrating Presser Bar Cap Bracket Screw (long).....
128E	901	Vibrating Presser Bar Cap Bracket Screw (short).....
58239	4491	Vibrating Presser Bar Guide Bracket with 874E and 1497F.....
1497F	4491	Vibrating Presser Bar Guide Bracket Set Screw.....
681D	862	Vibrating Presser Bar Hinge Screw.....
11563	862	" " " Spring Stud with 19877.....
19877	890	Vibrating Presser Bar Spring Stud Pin....
190E	899	" " " " " Screw
11564	862	" " " " " Spring
58240	4491	" " " Stop Block.....
682D	862	" " " " " Thumb Screw.....
6312	862	Vibrating Presser Bar Stop Block Thumb Screw Washer.....
874E	4491	Vibrating Presser Bar Stop Block Stop Screw.....
19595	884	Vibrating Presser Foot.....
690D	4451	" " " " Screw.....
1654c	903	" " " " Nut.....

**LIST OF PARTS COMPLETE
FOR
MACHINE No. 7-29**

**FOR SAILS, AWNINGS, TENTS, WAGON COVERS AND OTHER
HEAVY WORK. STITCH $\frac{1}{8}$ TO $\frac{1}{2}$ INCH LONG. HAS
CYLINDER SHUTTLE NO. 43285, DROP FEED, HINGED
PRESSER FOOT AND S. D. A.**

NO.	PLATE	NAME
*19959	—	Arm with 15404 and two 15405.....
8702	887	" Dowel Pin.....
127848	9608	" Oil Cup, for oiling Arm Shaft Front and Back Bearings.....
58564	9608	Arm Oil Tube, for oiling Arm Shaft Inter- mediate Bearing.....
50348E	9619	Arm Screw.....
58329	4495	" Shaft.....
11354	830	" " Bushing.....
437C	899	" " " Set Screw.....
949E	4494	" " " Screw.....
9842	4492	" " " Washer.....
11913	825	" Side Cover.....
65D	899	" " " Hinge Screw.....
8708	827	" Spool Pin.....
11241	858	" " " Washer (cloth).....
122301	—	Balance Wheel with two 354c.....
122302	4496	" " 122301 with 11442, 122469, two 1402E and four 40LE.....
25362	9621	Balance Wheel Ball, size $\frac{3}{16}$ in.....
122303	—	" " " Ring.....
122304	4493	" " " " 122303 with eighteen 25362.....
122306	4493	Balance Wheel Ball Washer (left).....
122469	9616	" " " " (right).....
1402E	4494	" " " " " Screw.....
11442	896	" " Friction Washer (paper).....
401E	899	" " " " " Screw.....
354c	899	" " Set Screw.....
*11922	—	Bed.....
24131	9608	" Oil Tube with 52045, for oiling Feed Rock Shaft (back) Bearing.....
58549	9608	Bed Oil Tube with 52045, for oiling Feed Lifting and Feed Rock Shaft (front) Bearings.....

NO.	PLATE	NAME
52045	9608	Bed Oil Tube Packing (felt).....
19704	916	Cloth Plate.....
894D	899	" " Screw.....
11363	825	Crank Connecting Rod.....
565c	898	" " " Hinge Screw.....
1513J	890	" " " " " Nut.....
11365	828	Feed Bar.....
307c	898	" " Screw Center.....
56814	—	" " " " 307c with 1513J.....
1513J	890	" " " " Nut.....
11367	830	" Cam with two 445c.....
445c	900	" " Set Screw.....
11368	830	" Connecting Link.....
565c	898	" " " Hinge Screw.....
1513J	890	" " " " " Nut.....
19705	917	" Dog, 8 teeth (7 teeth to the inch) for 19711 and 58386.....
166E	899	Feed Dog Screw.....
11370	825	" Forked Connection.....
565c	898	" " " Hinge Screw.....
1513J	890	" " " " " Nut.....
19970	4420	" Lifting Rock Shaft with 134E, 2022 and 19967.....
19971	—	Feed Lifting Rock Shaft complete, Nos. 19812 and 19970.....
19812	4421	Feed Lifting Rock Shaft Crank with 346E and 1861.....
346E	4453	Feed Lifting Rock Shaft Crank Clamping Screw.....
1861	862	Feed Lifting Rock Shaft Crank Roller and Stud.....
564c	898	Feed Lifting Rock Shaft Screw Center
58384	—	" " " " " " "
1508J	890	564c with 1508J.....
19967	861	Feed Lifting Rock Shaft Screw Center Nut.....
2022	887	Feed Lifting Rock Shaft Wearing Block Position Pin.....
134E	900	Feed Lifting Rock Shaft Wearing Block Screw.....
11375	830	Feed Regulator.....
568E	898	" " Hinge Screw.....
50322D	4489	" " Thumb Screw.....
58233	4490	" Rock Shaft.....
58234	—	Feed Rock Shaft complete, Nos. 58233 and 58235.....

NO.	PLATE	NAME
58235	4491	Feed Rock Shaft Crank with 346c.....
346E	4453	" " " " Clamping Screw.
564c	898	" " " " Screw Center.....
58384	—	" " " " " 564c with 1508J.....
1508J	890	Feed Rock Shaft Screw Center Nut.....
36577	4417	Guide (6 in. face).....
885D	902	" Thumb Screw.....
11928	842	Needle Bar.....
*11539	856	" " Connecting Link.....
566c	898	" " " " Hinge Screw
1513J	890	" " " " " " "
		Nut.....
11383	887	Needle Bar Connecting Stud with two 445F.....
19981	—	Needle Bar Connecting Stud 11383 with 11539.....
445F	900	Needle Bar Connecting Stud Set Screw...
258E	899	" " Screw Bushing.....
19702	890	" Clamp with 680F and 11385.....
*11385	890	" " Gib.....
680F	862	" " Thumb Screw.....
58253	—	Oil Cup.....
11917	825	" " Cover.....
9084	889	" " " Hinge Pin.....
2205	887	" " " Latch Spring.....
207F	901	" " " " Screw.....
8953	874	" or Wax Stripper (felt).....
11918	888	" " " " Washer (steel) for 11917.....
8482	890	Oil or Wax Stripper Washer (steel) for 58253.....
207F	901	Oil or Wax Stripper Washer Screw.....
58254	4490	Oil Cup complete, Nos. 2205, 8482, 9084, 11917, 11918, 58253, two 8953 and three 207F.....
134E	900	Oil Cup Screw.....
58573	9625	Oscillating Rock Shaft.....
58566	—	Oscillating Rock Shaft complete, Nos. 1508J, 11165, 51237c, 58570, 58573 and 58586.....
58585	9625	Oscillating Rock Shaft Hinge Pin.....
58586	—	" " " " " 5 8 5 8 5 with 1508J.....
1508J	890	Oscillating Rock Shaft Hinge Pin Nut....
51237c	9619	" " " " " " Screw Bearing.....

NO.	PLATE	NAME
1508J	890	Oscillating Rock Shaft Hinge Pin Screw Bearing Nut.....
11165	897	Oscillating Rock Shaft Oil Pad.....
58567	—	" " " " Tube with 58569.....
58570	9616	Oscillating Rock Shaft Oil Tube complete, Nos. 58567, 58568 and 127848.....
58568	9616	Oscillating Rock Shaft Oil Tube Joint....
127848	9608	" " " " " Oil Cup
*58569	—	" " " " " Sleeve
11929	916	" Shaft.....
11393	887	" Collar with two 453c....
453c	899	" " " Set Screw.....
11930	—	" " Crank.....
19697	4421	Oscillating Shaft Crank complete, Nos. 453c, 1513J, 5868 and 11930.....
40025	4492	Oscillating Shaft Crank Pin.....
453c	899	" " " Set Screw.....
9119	4421	" " " Slide Block.....
5868	4421	Oscillating Shaft Crank Slide Block com- plete, Nos. 190E, 1054c, 5968 and 9119
190E	899	Oscillating Shaft Crank Slide Block Cap Screw.....
5968	887	Oscillating Shaft Crank Slide Block Cap Screw Washer.....
1054c	4421	Oscillating Shaft Crank Slide Block Screw Stud.....
1513J	890	Oscillating Shaft Crank Slide Block Screw Stud Nut.....
11402	828	Presser Bar.....
11404	827	" " Guide Bracket with 159E, 353c and 453c.....
159E	901	Presser Bar Guide Bracket Adjusting Screw.....
453c	899	Presser Bar Guide Bracket Set Screw....
11405	830	" " " " Guide.....
381E	899	" " " " " Screw..
11909	830	" " Lifter with 8761 and 8763....
8760	888	" " " Friction Washer.....
16D	899	" " " Hinge Screw.....
8761	890	" " " Stop Pin.....
11906	827	" " Lifting Link.....
353c	899	" " " Cap Screw.....
8763	890	" " " Hinge Stud....
8973	862	" " " " " Pin
43267	4492	" " " " " Washer
258E	899	" " Screw Bushing.....

NO.	PLATE	NAME
11409	827	Presser Bar Spring.....
11411	887	“ “ “ Collar with 453c.....
	453c	899 “ “ “ Set Screw.....
	8582	889 “ Foot Hinge Pin.....
19706	—	“ “ Plate.....
19707	—	“ “ Shank.....
25837	904	“ “ Spring.....
19708	7821	Presser Foot (spring hinged) complete, Nos. 362F, 8582, 19706, 19707 and 25837
	362F	899 Presser Foot Screw.....
	252E	898 Pressure Regulating Thumb Screw.....
16901	9622	Shuttle Bobbin.....
43273	7816	“ “ Center Pin.....
43284	7822	“ Cylinder with 43273.....
43288	—	“ “ 43284 with 1323F and 58209.....
	8777	9621 Shuttle Cylinder Hinge Pin.....
43235	7818	“ “ Latch.....
43236	7816	“ “ “ Hinge Pin.....
19869	4423	“ “ “ Spring.....
43260	7823	“ Frame.....
43264	—	“ “ 43260 with 19869, 43235 and 43236.....
	1323F	901 Shuttle Tension Regulating Screw.....
58209	7822	“ “ Spring.....
43285	7822	Shuttle (cylinder) 4 in. diam., complete, Nos. 8777, 16901, 43264 and 43288.....
11932	882	Shuttle Driver with 445c.....
	8873	887 “ “ Pin.....
	445c	900 “ “ Set Screw.....
11933	882	“ Race with 11934 and four 164E... 123E 901 “ “ Clamping Screw.....
11934	882	“ “ Ring.....
	164E	899 “ “ Screw.....
11421	887	Tension Bracket.....
	190E	899 “ “ Screw.....
	8879	887 “ Friction Washer (cloth).....
11423	888	“ “ “ (steel).....
1560c	903	“ Regulating Thumb Nut.....
	8905	887 “ “ “ Washer
	411E	808 “ Screw Stud.....
58589	—	“ “ “ 411E with 1560c....
8791	888	“ Spring.....
11044	897	“ Wheel.....
58317	—	Tension (wheel) complete, Nos. 8791, 8905, 11044, 11423, 58589 and two 8879.....

NO.	PLATE	NAME
11424	888	Thread Eyelet (front of arm).....
11950	888	“ “ (side of arm).....
2102	888	“ Retaining Disc.....
1560c	903	“ “ Regulating Thumb Nut
8905	887	“ “ “ “ “
		Washer.....
686E	902	Thread Retaining Screw Stud.....
58590	—	“ “ “ “ 686E with 1560c.....
2103	888	Thread Retaining Spring.....
11041	—	Thread Retainer complete, Nos. 2103, 8905, 58590 and two 2102.....
11428	827	Thread Take-up Cam with two 434c....
	8873	887 “ “ “ Pin.....
	434c	899 “ “ “ Set Screw.....
58305	—	“ “ Lever.....
58306	7815	“ “ “ 58305 with 1995..
58337	—	“ “ “ 58306 with 50437D
50437D	4494	“ “ “ Hinge Screw.....
	1995	4452 “ “ “ Roller and Screw Stud with 1518J.....
	1518J	907 Thread Take-up Lever Roller and Screw Stud Nut.....
11052	887	Thread Take-up Spring.....
11431	888	“ “ “ Regulator Plate
	190E	899 “ “ “ “ “
		Adjusting Screw.....
19709	—	Throat Plate Body.....
19710	917	“ “ Needle Hole Strip for 19711.
58385	9609	“ “ “ “ “ “ 58386.
	389D	901 “ “ “ “ “ Screw... 19711 917 Throat Plate complete, for Nos. 26 and 27 Needles, for 19705, Nos. 19709, 19710 and two 389D.....
	58386	9609 Throat Plate complete, for Nos. 23 to 26 Needles, for 19705, Nos. 19709, 58385 and two 389D.....
	381D	899 Throat Plate Screw.....
*15404	—	Trade Mark.....
15405	4492	“ “ Rivet.....

**LIST OF PARTS COMPLETE
FOR
MACHINE No. 7-30**

FOR LIGHT HARNESS AND SIMILAR WORK IN LEATHER.
HAS PRESSER FOOT FOR PLAIN STITCHING. PRESSER
FEED POINT FOR $\frac{1}{8}$ IN. "SET" STITCH AND PRESSER
FEED POINTS FOR $\frac{1}{4}$, $\frac{1}{8}$, $\frac{1}{10}$ OR $\frac{1}{12}$ INCH STITCH CAN
BE FURNISHED IF ORDERED AT AN EXTRA COST. INDE-
PENDENT UPPER AND UNDER FEEDS, FOOT LIFTER AND
S. D. A.

NO.	PLATE	NAME
*19965	—	Arm with 15404 and two 15405.....
8702	887	" Dowel Pin.....
127848	9608	" Oil Cup, for oiling Arm Shaft Front and Back Bearings.....
58564	9608	Arm Oil Tube, for oiling Arm Shaft Inter- mediate Bearing.....
50348E	9619	Arm Screw.....
58329	4495	" Shaft.....
11354	830	" " Bushing.....
437c	899	" " " Set Screw.....
949E	4494	" " Screw.....
9842	4492	" " " Washer.....
19668	911	" Side Cover.....
65D	899	" " " Hinge Screw.....
8708	827	" Spool Pin.....
11241	858	" " " Washer (cloth).....
122301	—	Balance Wheel with two 354c.....
122302	4496	" " 122301 with 11442, 122469, two 1402E and four 401E.....
25362	9621	Balance Wheel Ball, size $\frac{3}{8}$ in.....
122303	—	" " " Ring.....
122304	4493	" " " " 122303 with eighteen 25362.....
122306	4493	Balance Wheel Ball Washer (left).....
122469	9616	" " " " (right).....
1402E	4494	" " " " " Screw
11442	896	" " Friction Washer (paper)..
401E	899	" " " " Screw....
354c	899	" " Set Screw.....
*11359	—	Bed.....
24131	9608	" Oil Tube with 52045, for oiling Feed Rock Shaft (back) Bearing.....

NO.	PLATE	NAME
58549	9608	Bed Oil Tube with 52045, for oiling Feed Lifting and Feed Rock Shaft (front) Bearings.....
52045	9608	Bed Oil Tube Packing (felt).....
11363	825	Crank Connecting Rod.....
565c	898	" " " Hinge Screw.....
1513J	890	" " " " " Nut
11365	828	Feed (lower) Bar.....
307c	898	" " " Screw Center.....
56814	—	" " " " " 307c with 1513J.....
1513J	890	Feed (lower) Bar Screw Center Nut.....
11367	830	" " Cam with two 445c.....
445c	900	" " " Set Screw.....
11368	830	" " Connecting Link.....
565c	898	" " " " H i n g e Screw.....
1513J	890	Feed (lower) Connecting Link Hinge Screw Nut.....
19899	4434	Feed (lower) Dog, 9 teeth (10 teeth to the inch) for 19908.....
19900	4434	Feed (lower) Dog (without teeth) for 19908.....
166E	899	Feed (lower) Dog Screw.....
11370	825	" " Forked Connection.....
565c	898	" " " " H i n g e Screw.....
1513J	890	Feed (lower) Forked Connection Hinge Screw Nut.....
19970	4420	Feed (lower) Lifting Rock Shaft with 134E, 2022 and 19967.....
19971	—	Feed (lower) Lifting Rock Shaft complete, Nos. 19812 and 19970.....
19812	4421	Feed (lower) Lifting Rock Shaft Crank with 346E and 1861.....
346E	4453	Feed (lower) Lifting Rock Shaft Crank Clamping Screw.....
1861	862	Feed (lower) Lifting Rock Shaft Crank Roller and Stud.....
564c	898	Feed (lower) Lifting Rock Shaft Screw Center.....
58384	—	Feed (lower) Lifting Rock Shaft Screw Center 564c with 1508E.....
1508E	890	Feed (lower) Lifting Rock Shaft Screw Center Nut.....
19967	861	Feed (lower) Lifting Rock Shaft Wearing Block.....

NO.	PLATE	NAME
2022	887	Feed (lower) Lifting Rock Shaft Wearing Block Position Pin.....
134E	900	Feed (lower) Lifting Rock Shaft Wearing Block Screw.....
11375	830	Feed (lower) Regulator.....
568E	898	" " " Hinge Screw.....
50322D	4489	" " " Thumb Screw.....
58233	4490	" " Rock Shaft.....
58234	—	Feed (lower) Rock Shaft complete, Nos. 58233 and 58235.....
58235	4491	Feed (lower) Rock Shaft Crank with 346E
346E	4453	" " " " " Clamp- ing Screw.....
564c	898	Feed (lower) Rock Shaft Screw Center
58384	—	" " " " " " 564c with 1508J.....
1508J	890	Feed (lower) Rock Shaft Screw Center Nut.....
19544	845	Feed (upper) Bar.....
19546	845	" " " Guide Bracket (lower) with 456c and 1192c.....
19726	—	Feed (upper) Bar Guide Bracket (lower) complete, Nos. 19546, 19547 and two 190E.....
19547	845	Feed (upper) Bar Guide Bracket (lower) Cap.....
190E	899	Feed (upper) Bar Guide Bracket (lower) Cap Screw.....
1192c	9620	Feed (upper) Bar Guide Bracket (lower) Position Screw.....
456c	9620	Feed (upper) Bar Guide Bracket (lower) Set Screw.....
19545	884	Feed (upper) Bar Guide Bracket (upper)
145E	899	" " " " " " Screw.....
11071	878	Feed (upper) Bar Hinge Bracket with 145E, 193F, 434c and 832c.....
145E	899	Feed (upper) Bar Hinge Bracket Adjusting Screw.....
19675	911	Feed (upper) Bar Hinge Bracket Guide Plate.....
381E	899	Feed (upper) Bar Hinge Bracket Guide Plate Screw.....
832c	9620	Feed (upper) Bar Hinge Bracket Set Screw (long).....
434c	899	Feed (upper) Bar Hinge Bracket Set Screw (short).....

NO.	PLATE	NAME
448c	900	Feed (upper) Bar Hinge Bracket Support Screw.....
1520J	905	Feed (upper) Bar Hinge Bracket Support Screw Nut.....
11072	889	Feed (upper) Bar Hinge Pin.....
193F	901	" " " " " Set Screw...
58511	9623	" " Cam with two 445c.....
445c	900	" " " Set Screw.....
19527	845	" " Connecting Link.....
65D	899	" " " " " H i n g e Screw.....
19528	865	Feed (upper) Regulator with 231c and 453c.....
912c	903	Feed (upper) Regulator Adjusting Screw
1596D	903	" " " " " Nut.....
19529	9621	Feed (upper) Regulator Adjusting Screw Sleeve.....
231c	901	Feed (upper) Regulator Adjusting Screw Stop Screw.....
3012	853	Feed (upper) Regulator Pin.....
453c	899	" " " Set Screw.....
19677	910	" " " Shaft.....
11393	887	" " " " Collar with two 453c.....
453c	899	Feed (upper) Regulator Shaft Collar Set Screw.....
11708	846	Feed (upper) Regulator Shaft Driving Crank with 453c and 1804.....
3012	853	Feed (upper) Regulator Shaft Driving Crank Pin.....
1804	899	Feed (upper) Regulator Shaft Driving Crank Roller and Stud.....
453c	899	Feed (upper) Regulator Shaft Driving Crank Set Screw.....
11698	847	Feed (upper) Shaft.....
19531	865	" " " Crank with 453c, 1518J and 1845.....
2117	890	Feed (upper) Shaft Crank Pin.....
1845	899	" " " " Roller and Screw Stud.....
1518J	907	Feed (upper) Shaft Crank Roller and Screw Stud Nut.....
453c	899	Feed (upper) Shaft Crank Set Screw.....
19532	869	" " " Driving Crank with 453c.....

NO.	PLATE	NAME
2117	890	Feed (upper) Shaft Driving Crank Pin
453c	890	" " " " " Set
		Screw.....
25881	894	Guide (6 in. face).....
254D	902	" Thumb Screw.....
19535	—	Lifting Presser Bar.....
19536	848	" " " 19535 with 64052.....
19680	910	" " " Bell Crank.....
19681	—	Lifting Presser Bar Bell Crank complete, Nos. 611c, 19540 and 19680.....
19539	—	Lifting Presser Bar Bell Crank Adjusting Link.....
19540	845	Lifting Presser Bar Bell Crank Adjusting Link complete, Nos. 1518r, 1828, 2718 and 19539.....
1828	899	Lifting Presser Bar Bell Crank Adjusting Link Roller with 372c.....
372c	898	Lifting Presser Bar Bell Crank Adjusting Link Roller Screw.....
1518r	907	Lifting Presser Bar Bell Crank Adjusting Link Roller Screw Nut.....
2718	897	Lifting Presser Bar Bell Crank Adjusting Link Roller Screw Nut Washer.....
611c	905	Lifting Presser Bar Bell Crank Adjusting Link Screw.....
19682	913	Lifting Presser Bar Bell Crank Connecting Stud with 445c and 523c.....
523c	901	Lifting Presser Bar Bell Crank Connecting Stud Set Screw (large).....
445c	900	Lifting Presser Bar Bell Crank Connecting Stud Set Screw (small).....
51260D	9619	Lifting Presser Bar Bell Crank Hinge Screw.....
51609E	9620	Lifting Presser Bar Bell Crank Hinge Screw Nut.....
11909	830	Lifting Presser Bar Lifter with 8761 and 8763.....
8760	888	Lifting Presser Bar Lifter Friction Washer
16D	899	" " " " Hinge Screw...
8761	890	" " " " Stop Pin.....
19541	848	" " " Lifting Link.....
65D	899	" " " " " H i n g e Screw.....
8763	890	Lifting Presser Bar Lifting Link Hinge Stud.....
8973	862	Lifting Presser Bar Lifting Link Hinge Stud Pin.....

NO.	PLATE	NAME
43267	4492	Lifting Presser Bar Lifting Link Hinge Stud Washer.....
257E	902	Lifting Presser Bar Screw Bushing (lower)
913E	903	" " " " " (upper)
11031	863	" " " Spring (flat).....
58252	4493	" " " " Bracket.....
1177E	4494	" " " " " Screw
11661	9608	" " " " Guide Pin.....
50323D	4489	" " " " R e g u l a t i n g Thumb Screw.....
19901	4434	Lifting Presser Foot for 19899.....
19720	921	" " " (stitch set) with ex- tended toe on right hand side, for 19900
19721	921	Lifting Presser Foot (stitch set) for stitch- ing cruppers, for 19900.....
19722	921	Lifting Presser Foot (stitch set) double toe, for 19900.....
11075	921	Lifting Presser Foot Packing.....
166E	899	" " " Screw.....
19794	4427	Needle Bar.....
*19564	869	" " Connecting Link.....
566c	898	" " " " Hinge Screw
1513r	890	" " " " " " "
		Nut.....
19902	874	Needle Bar Connecting Stud with two 445F.....
445F	900	Needle Bar Connecting Stud Set Screw...
257E	902	" " Screw Bushing.....
9060	874	" Clamp with 149F and 8749.....
8749	874	" " Gib.....
149F	874	" " Screw.....
11916	849	" Plate.....
381D	899	" " Screw.....
58253	—	Oil Cup.....
11917	825	" " Cover.....
9084	889	" " " Hinge Pin.....
2205	887	" " " Latch Spring.....
207F	901	" " " " " Screw.....
8953	874	" or Wax Stripper (felt).....
11918	888	" " " " Washer (steel) for 11917.....
8482	890	Oil or Wax Stripper Washer (steel) for 58253.....
207F	901	Oil or Wax Stripper Washer Screw.....
58254	4490	Oil Cup complete, Nos. 2205, 8482, 9084, 11917, 11918, 58253, two 8953 and three 207F.....

NO.	PLATE	NAME
134E	900	Oil Cup Screw.....
58573	9625	Oscillating Rock Shaft.....
58566	—	Oscillating Rock Shaft complete, Nos. 1508J, 11165, 51237c, 58570, 58573 and 58586.....
58585	9625	Oscillating Rock Shaft Hinge Pin.....
58586	—	“ “ “ “ “ 5 8 5 8 5 with 1508J.....
1508J	890	Oscillating Rock Shaft Hinge Pin Nut....
51237c	9619	“ “ “ “ “ Screw Bearing.....
1508J	890	Oscillating Rock Shaft Hinge Pin Screw Bearing Nut.....
11165	897	Oscillating Rock Shaft Oil Pad.....
58567	—	“ “ “ “ “ Tube with 58569.....
58570	9616	Oscillating Rock Shaft Oil Tube complete, Nos. 58567, 58568 and 127848.....
58568	9616	Oscillating Rock Shaft Oil Tube Joint....
127848	9608	“ “ “ “ “ Oil Cup..
*58569	—	“ “ “ “ “ Sleeve
11850	825	“ Shaft.....
11393	887	“ “ Collar with two 453c....
453c	899	“ “ “ Set Screw.....
11848	—	“ “ Crank.....
19696	4421	Oscillating Shaft Crank complete, Nos. 453c, 1513J, 5868 and 11848.....
40025	4492	Oscillating Shaft Crank Pin.....
453c	899	“ “ “ Set Screw.....
9119	4421	“ “ “ Slide Block.....
5868	4421	Oscillating Shaft Crank Slide Block com- plete, Nos. 190E, 1054c, 5968 and 9119..
190E	899	Oscillating Shaft Crank Slide Block Cap Screw.....
5968	887	Oscillating Shaft Crank Slide Block Cap Screw Washer.....
1054c	4421	Oscillating Shaft Crank Slide Block Screw Stud.....
1513J	890	Oscillating Shaft Crank Slide Block Screw Stud Nut.....
11910	7268	Shuttle Bobbin.....
19977	7268	“ Cylinder.....
58213	—	“ “ 19977 with 773F and 19979.....
58527	9621	Shuttle Cylinder Hinge Pin.....
58979	9611	“ “ Latch.....
12002	7268	“ “ “ Pin.....

NO.	PLATE	NAME
122419	9621	Shuttle Cylinder Latch Spring.....
58523	9612	“ “ Frame.....
58524	—	“ “ 58523 with 12002, 58979 and 122419.....
773F	7268	Shuttle Tension Regulating Screw.....
19979	7268	“ “ Spring.....
58525	9613	Shuttle (cylinder) 3 in. diam., complete, Nos. 11910, 58213, 58524 and 58527....
11856	830	Shuttle Driver with 453c.....
2117	890	“ “ Pin.....
453c	899	“ “ Set Screw.....
11832	830	“ Race Back.....
11833	889	“ “ “ Position Pin.....
19577	864	“ “ “ Spring.....
32D	901	“ “ “ “ Screw.....
11835	—	“ “ Body.....
11836	825	Shuttle Race complete, Nos. 32D, 11832, 11835, 19577 and two 11833.....
134E	900	Shuttle Race Screw.....
11837	825	“ “ Frame with 11838.....
670E	862	“ “ “ Clamping Screw.....
11838	889	“ “ “ Position Pin.....
11418	858	“ “ Slide (left).....
11500	851	“ “ “ (right).....
180D	901	“ “ “ “ Screw.....
19903	4435	Tension Bracket.....
193F	901	“ “ “ Screw.....
8879	887	“ Friction Washer (cloth).....
11043	897	“ “ “ (steel).....
1560c	903	“ Regulating Thumb Nut.....
8905	887	“ “ “ “ Washer
632E	862	“ Screw Stud.....
58596	—	“ “ “ 632E with 1560c....
8791	888	“ Spring.....
11044	897	“ Wheel.....
11042	—	Tension (wheel) complete, Nos. 8791, 8905, 11043, 11044, 58596 and two 8879
11950	888	Thread Eyelet (side of arm).....
2102	888	“ Retaining Disc.....
1560c	903	“ “ Regulating Thumb Nut
8905	887	“ “ “ “ “ “ Washer.....
686E	902	Thread Retaining Screw Stud.....
58590	—	“ “ “ “ 686E with 1560c.....
2103	888	Thread Retaining Spring.....

NO.	PLATE	NAME
11041	—	Thread Retainer complete, Nos. 2103, 8905, 58590 and two 2102.....
11428	827	Thread Take-up Cam with two 434c.....
8873	887	" " " Pin.....
434c	899	" " " Set Screw.....
58299	—	" " Lever.....
58300	4493	" " " 58299 with 1948 and 1995.....
58315	—	Thread Take-up Lever 58300 with 50437D
50437D	4494	" " " Hinge Screw.....
1995	4452	" " " Roller and Screw Stud with 1518J.....
1518J	907	Thread Take-up Lever Roller and Screw Stud Nut.....
1948	4452	Thread Take-up Lever Thread Guiding Roller and Screw Stud.....
19690	914	Thread Take-up Spring.....
19614	879	" " " Hook for 19906...
8077	879	" " " " " 19904...
19904	4435	" " " Lever with 8077...
19905	4435	" " " Collar.....
58273	4492	" " " Stop Pin...
19906	4435	" " " Regulator with 19614 and 58273.....
164E	899	Thread Take-up Spring Regulator Screw...
19907	4435	" " " Staple.....
690E	4451	" " " Screw.....
41544	4415	" " " Washer
19908	4434	Throat Plate for 19899 and 19900.....
381D	899	" " Screw.....
*15404	—	Trade Mark.....
15405	4492	" " Rivet.....

Genuine Singer Needles should be used in Singer Machines. These Needles and their Containers are marked with the Company's Trade Mark "SIMANCO." 1

Needles in Containers marked "For Singer Machines" are not Singer made needles. 2

LIST OF PARTS COMPLETE FOR MACHINE No. 7-32

FOR STITCHING BUFF WHEELS NOT MORE THAN $\frac{3}{8}$ INCH THICK AND 18 IN. DIAM. MAKES CIRCULAR ROWS OF STITCHING FROM $\frac{1}{4}$ TO $\frac{1}{2}$ INCH BETWEEN THE LINES OF STITCHING AS ORDERED, AND AUTOMATICALLY CHANGES FROM THE FINISHED ROW TO THE BEGINNING ON THE NEXT. STITCH $\frac{1}{8}$ TO $\frac{1}{16}$ INCH LONG. HAS DROP FEED, ALTERNATING PRESSER AND BELT SHIFTER.

NO.	PLATE	NAME
*19502	—	Arm with 15404 and two 15405.....
8702	887	" Dowel Pin.....
127848	9608	" Oil Cup, for oiling Arm Shaft Front and Back Bearings.....
58565	9608	Arm Oil Tube, for oiling Arm Shaft Intermediate Bearing.....
50348E	9619	Arm Screw.....
11878	838	" Shaft.....
11354	830	" " Bushing.....
437c	899	" " " Set Screw.....
11913	825	" Side Cover.....
65D	899	" " Hinge Screw.....
8708	827	" Spool Pin.....
11241	858	" " " Washer (cloth).....
58407	9631	Balance Wheel and Pulley (tight) with two 354c.....
354c	899	Balance Wheel and Pulley (tight) Set Screw.....
*19597	—	Bed.....
*19598	—	" Extension with 19633.....
8873	887	" " Dowel Pin.....
123E	901	" " Screw.....
24131	9608	" Oil Tube with 52045, for oiling Feed Rock Shaft (back) Bearing.....
58549	9608	Bed Oil Tube with 52045, for oiling Feed Lifting and Feed Rock Shaft (front) Bearings.....
52045	9608	Bed Oil Tube Packing (felt).....
9159	4442	Buff Wheel Clamp Carrier with 19614....
9160	4442	" " " " Cap.....
691F	905	" " " " " Screw....
19614	879	" " " " Hook.....

NO.	PLATE	NAME
19611	880	Buff Wheel Clamp Spindle Gear with 462c.....
2049	853	Buff Wheel Clamp Spindle Gear Pin.....
402c	4451	" " " " " Set Screw
9170	4443	" " " " " Plate with three 9199.....
401D	899	Buff Wheel Clamp Spindle Plate Screw...
9199	879	" " " " " Spur....
50201F	4453	" " Thumb Screw.....
19628	880	" " " " Washer.....
19909	4497	Cloth Plate.....
389F	901	" " Screw.....
11363	825	Crank Connecting Rod.....
565c	898	" " " Hinge Screw.....
1513J	890	" " " " " Nut
19630	877	Feed Bar.....
307c	898	" " Screw Center.....
56814	—	" " " " 307c with 1513J..
1513J	890	" " " " Nut.....
11367	830	" Cam with two 445c.....
445c	900	" " Set Screw.....
11368	830	" Connecting Link.....
565c	898	" " " Hinge Screw.....
1513J	890	" " " " " Nut..
9173	4444	" Dog, 5 teeth (8 teeth to the inch) for 19917.....
19632	877	Feed Dog Carrier with 8077.....
568c	898	" " " Hinge Screw.....
13175	4443	" " " Spring.....
8077	879	" " " Hook for 19632.
19633	879	" " " " " 19598.
166E	899	" " Screw.....
11370	825	" Forked Connection.....
565c	898	" " " Hinge Screw....
1513J	890	" " " " " Nut
19970	4420	" Lifting Rock Shaft with 134E, 2022 and 19967.....
19972	—	Feed Lifting Rock Shaft complete, Nos. 19816 and 19970.....
19816	4439	Feed Lifting Rock Shaft Crank with 346E, 1513J and 1885.....
346E	4453	Feed Lifting Rock Shaft Crank Clamping Screw.....
1885	900	Feed Lifting Rock Shaft Crank Roller with 190E, 1054c and 5968.....
190E	899	Feed Lifting Rock Shaft Crank Roller Cap Screw.....

NO.	PLATE	NAME
5968	887	Feed Lifting Rock Shaft Crank Roller Cap Screw Washer.....
1054c	4421	Feed Lifting Rock Shaft Crank Roller Screw Stud.....
1513J	890	Feed Lifting Rock Shaft Crank Roller Screw Stud Nut.....
564c	898	Feed Lifting Rock Shaft Screw Center...
58384	—	" " " " " 564c with 1508J.....
1508J	890	Feed Lifting Rock Shaft Screw Center Nut.....
19967	861	Feed Lifting Rock Shaft Wearing Block
2022	887	" " " " " " Position Pin.....
134E	900	Feed Lifting Rock Shaft Wearing Block Screw.....
11375	830	Feed Regulator.....
568E	898	" " Hinge Screw.....
50322D	4489	" " Thumb Screw.....
58233	4490	" Rock Shaft.....
58234	—	Feed Rock Shaft complete, Nos. 58233 and 58235.....
58235	4491	Feed Rock Shaft Crank with 346E.....
346E	4453	" " " Clamping Screw
564c	898	" " " Screw Center.....
58384	—	" " " " " 564c with 1508J.....
1508J	890	Feed Rock Shaft Screw Center Nut.....
19634	880	Guide Pin, for circular stitching.....
19635	876	" Plate, for circular stitching.....
NOTE: When ordering No. 19635, state distance between rows of stitching.		
691F	905	Guide Plate Screw.....
11475	851	Lifting Presser Bar.....
11476	850	" " " Bell Crank.....
166E	899	" " " " " Hinge Cap Screw.....
1851	900	Lifting Presser Bar Bell Crank Lifting Roller with 610E.....
610E	901	Lifting Presser Bar Bell Crank Lifting Roller Screw.....
1518J	907	Lifting Presser Bar Bell Crank Lifting Roller Screw Nut.....
2718	897	Lifting Presser Bar Bell Crank Lifting Roller Screw Nut Washer.....

NO.	PLATE	NAME
19910	4445	Lifting Presser Bar Bracket with 145E and 647E.....
647E	4451	Lifting Presser Bar Bracket Clamping Screw (lower).....
145E	899	Lifting Presser Bar Bracket Clamping Screw (upper).....
11909	830	Lifting Presser Bar Lifter with 8761 and 8763.....
8760	888	Lifting Presser Bar Lifter Friction Washer
16D	899	" " " " Hinge Screw...
8761	890	" " " " Stop Pin.....
19911	4445	" " " " Lifting Link.....
8763	890	" " " " " Hinge Stud.....
8973	862	Lifting Presser Bar Lifting Link Hinge Stud Pin.....
43267	4492	Lifting Presser Bar Lifting Link Hinge Stud Washer.....
11479	852	Lifting Presser Bar Rock Shaft.....
58578	9618	" " " " " Adjusting Arm with 453c.....
2117	890	Lifting Presser Bar Rock Shaft Adjusting Arm Pin.....
453c	899	Lifting Presser Bar Rock Shaft Adjusting Arm Set Screw.....
11481	851	Lifting Presser Bar Rock Shaft Bracket
2002	853	" " " " " " Dowel Pin (lower).....
4389	853	Lifting Presser Bar Rock Shaft Bracket Dowel Pin (upper).....
123E	901	Lifting Presser Bar Rock Shaft Bracket Screw.....
11484	852	Lifting Presser Bar Rock Shaft Crank with 453c and 1850.....
2117	890	Lifting Presser Bar Rock Shaft Crank Pin.....
1850	900	Lifting Presser Bar Rock Shaft Crank Roller and Stud.....
453c	899	Lifting Presser Bar Rock Shaft Crank Set Screw.....
11486	850	Lifting Presser Bar Rock Shaft Eccentric Strap with two each 141E and 1528c..
141E	901	Lifting Presser Bar Rock Shaft Eccentric Strap Adjusting Screw.....
1528c	903	Lifting Presser Bar Rock Shaft Eccentric Strap Adjusting Screw Nut.....

NO.	PLATE	NAME
608E	900	Lifting Presser Bar Rock Shaft Eccentric Strap Hinge Screw.....
1518J	907	Lifting Presser Bar Rock Shaft Eccentric Strap Hinge Screw Nut.....
11487	853	Lifting Presser Bar Rock Shaft Eccentric Strap Hinge Screw Slide.....
11488	853	Lifting Presser Bar Rock Shaft Eccentric Strap Hinge Screw Slide Washer.....
258E	899	Lifting Presser Bar Screw Bushing.....
11489	852	" " " Sleeve (lower).....
19912	4443	" " " " (upper).....
19913	—	" " " " " 19912 with 11492.....
11492	853	Lifting Presser Bar Sleeve (upper) Cap...
11493	825	" " " Spring (flat).....
58252	4493	" " " " Bracket.....
1177E	4494	" " " " " Screw
11661	9608	" " " " Guide Pin.....
50323D	4489	" " " " " Regulating Thumb Screw.....
19914	4444	Lifting Presser Foot with 211F.....
2049	853	" " " Pin.....
211F	901	" " " Set Screw.....
11538	855	Needle Bar.....
*11539	856	" " Connecting Link.....
566C	898	" " " " Hinge Screw
1513J	890	" " " " " " Nut.....
11383	887	Needle Bar Connecting Stud with two 445F.....
19981	—	Needle Bar Connecting Stud 11383 with 11539.....
445F	900	Needle Bar Connecting Stud Set Screw...
258E	899	" " Screw Bushing.....
19702	890	" Clamp with 680F and 11385.....
*11385	890	" " Gib.....
680F	862	" " Thumb Screw.....
58253	—	Oil Cup.....
11917	825	" " Cover.....
9084	889	" " " Hinge Pin.....
2205	887	" " " Latch Spring.....
207F	901	" " " " " Screw.....
8953	874	" or Wax Stripper (felt).....
11918	888	" " " " Washer (steel) for 11917.....
8482	890	Oil or Wax Stripper Washer (steel) for 58253.....

NO.	PLATE	NAME
207F	901	Oil or Wax Stripper Washer Screw.....
58254	4490	Oil Cup complete, Nos. 2205, 8482, 9084, 11917, 11918, 58253, two 8953 and three 207F.....
134E	900	Oil Cup Screw.....
58573	9625	Oscillating Rock Shaft.....
58566	—	Oscillating Rock Shaft complete, Nos. 1508J, 11165, 51237c, 58570, 58573 and 58586.....
58585	9625	Oscillating Rock Shaft Hinge Pin.....
58586	—	“ “ “ “ “ 58585 with 1508J.....
1508J	890	Oscillating Rock Shaft Hinge Pin Nut....
51237c	9619	“ “ “ “ “ Screw Bearing.....
1508J	890	Oscillating Rock Shaft Hinge Pin Screw Bearing Nut.....
11165	897	Oscillating Rock Shaft Oil Pad.....
58567	—	“ “ “ “ Tube with 58569.....
58570	9616	Oscillating Rock Shaft Oil Tube complete, Nos. 58567, 58568 and 127848.....
58568	9616	Oscillating Rock Shaft Oil Tube Joint....
127848	9608	“ “ “ “ “ Oil Cup.
*58569	—	“ “ “ “ “ Sleeve
11850	825	“ Shaft.....
11393	887	“ “ Collar with two 453c....
453c	899	“ “ “ Set Screw.....
11848	—	“ “ Crank.....
19696	4421	Oscillating Shaft Crank complete, Nos. 453c, 1513J, 5868 and 11848.....
40025	4492	Oscillating Shaft Crank Pin.....
453c	899	“ “ “ Set Screw.....
9119	4421	“ “ “ Slide Block.....
5868	4421	Oscillating Shaft Crank Slide Block com- plete, Nos. 190J, 1054c, 5968 and 9119
190J	899	Oscillating Shaft Crank Slide Block Cap Screw.....
5968	887	Oscillating Shaft Crank Slide Block Cap Screw Washer.....
1054c	4421	Oscillating Shaft Crank Slide Block Screw Stud.....
1513J	890	Oscillating Shaft Crank Slide Block Screw Stud Nut.....
11910	7268	Shuttle Bobbin.....
11852	833	“ Cylinder.....
*19986	—	“ “ 11852 with 773F and 8964

NO.	PLATE	NAME
8961	833	Shuttle Cylinder Hinge Pin.....
11853	833	“ “ Latch.....
12002	7268	“ “ “ Pin.....
11854	833	“ “ “ Spring.....
590D	901	“ “ “ “ Screw.....
19637	881	“ Frame.....
58294	—	“ “ 19637 with 590D, 11853, 11854 and 12002.....
773F	7268	Shuttle Tension Regulating Screw.....
8964	833	“ “ Spring.....
19636	4429	Shuttle (cylinder) 3 in. diam., complete, Nos. 8961, 11910, 19986 and 58294.....
11856	830	Shuttle Driver with 453c.....
2117	890	“ “ Pin.....
453c	899	“ “ Set Screw.....
19638	877	“ Race Back.....
11833	889	“ “ “ Position Pin.....
19577	864	“ “ “ Spring.....
32D	901	“ “ “ “ Screw.....
19639	877	“ “ Body.....
19640	—	Shuttle Race complete, Nos. 32D, 19577, 19638, 19639 and two 11833.....
134E	900	Shuttle Race Screw.....
11837	825	“ “ Frame with 11838.....
670E	862	“ “ “ Clamping Screw.....
11838	889	“ “ “ Position Pin.....
8879	887	Tension Friction Washer (cloth).....
11423	888	“ “ “ (steel).....
1560c	903	“ Regulating Thumb Nut.....
8905	887	“ “ “ “ Washer..
411E	898	“ Screw Stud.....
58589	—	“ “ “ 411E with 1560c....
11422	888	“ Spring.....
11044	897	“ Wheel.....
11420	—	Tension (wheel) complete, Nos. 8905, 11044, 11422, 11423, 58589 and two 8879
11424	888	Thread Eyelet for 19919.....
11950	888	“ “ “ 11503.....
11495	9608	“ “ (side of arm).....
190E	899	“ “ “ “ “ Screw.....
2102	888	“ Retaining Disc.....
1560c	903	“ “ Regulating Thumb Nut
8905	887	“ “ “ “ “
		Washer.....
606E	902	Thread Retaining Screw Stud.....
58597	—	“ “ “ “ 606E with 1560c.....

NO.	PLATE	NAME
2103	888	Thread Retaining Spring.....
11503	—	Thread Retainer complete, Nos. 2103, 8905, 58597 and two 2102.....
11505	851	Thread Take-up Cam with two 434c.....
8873	887	" " " Pin.....
434c	899	" " " Set Screw.....
58295	—	" " " Lever.....
58296	4493	" " " 58295 with 1995..
58320	—	" " " 58296 with 50437D
50437D	4494	" " " Hinge Screw.....
1995	4452	" " " Roller and Screw Stud with 1518J.....
1518J	907	Thread Take-up Lever Roller and Screw Stud Nut.....
11052	887	Thread Take-up Spring.....
11431	888	" " " Regulator Plate
190E	899	" " " " " "
		Adjusting Screw.....
19915	—	Throat Plate Body with 19620.....
19916	4444	" " " Needle Hole Strip.....
401D	899	" " " " " Screw...
19917	4444	Throat Plate complete for 9173, Nos. 19915, 19916 and two 401D.....
381D	899	Throat Plate Screw.....
*15404	—	Trade Mark.....
15405	4492	" " " Rivet.....
19918	4445	Vibrating Presser Bar.....
19919	4445	" " " Cap Bracket with 11424.....
145E	899	Vibrating Presser Bar Cap Bracket Screw.....
19920	4445	Vibrating Presser Bar Hinge Bracket with 145E.....
145E	899	Vibrating Presser Bar Hinge Bracket Adjusting Screw.....
23F	4451	Vibrating Presser Bar Hinge Screw.....
11512	851	" " " Spring.....
208E	4451	" " " " " Screw.....
19921	4443	" " " " " Stop.....
202E	900	" " " " " Screw.
19922	4443	" " " and Stretching Foot....
657c	903	" " " " " Hinge Screw.....
1620J	903	Vibrating Presser and Stretching Foot Hinge Screw Nut.....
25837	904	Vibrating Presser and Stretching Foot Spring.....

NO.	PLATE	NAME
19647	879	Vibrating Presser and Stretching Foot Spring Stud.....

MACHINE No. 7-35

FOR HARNESS AND OTHER WORK IN LEATHER NOT MORE THAN $\frac{5}{8}$ IN. THICK. MAKES "SET" STITCH BY USE OF POINTS ON PRESSER FOOT. HAS PRESSER FEED POINT FOR $\frac{1}{8}$ IN. STITCH. PRESSER FEED POINTS FOR $\frac{1}{4}$, $\frac{1}{5}$, $\frac{1}{10}$ AND $\frac{1}{12}$ IN. CAN BE FURNISHED IF SO ORDERED AT AN EXTRA COST. UPPER FEED, FOOT LIFTER, STITCH $\frac{3}{32}$ IN. TO $\frac{1}{4}$ IN. LONG. FOR FOOT POWER STAND OR UNDER DRIVER.

This Machine is the same as No. 7-14
with the following exceptions:

NO.	PLATE	NAME
11353	825	Arm Shaft, in place of 58329.....
11358	896	Balance Wheel (two speed) with two 354c, for Stand, in place of 122302.....
58411	9631	Balance Wheel with two 354c, for Under Driver, in place of 122302.....

MACHINE No. 7-36

HAS S. D. A.,

OTHERWISE SAME AS NO. 7-22

NO.	PLATE	NAME
58445	9628	Arm Shaft, in place of 11878.....
949E	4494	" " " Screw.....
9842	4492	" " " Washer.....
122301	—	Balance Wheel with two 354c.....
122302	4496	" " " 122301 with 11442, 122469, two 1402E and four 401E, in place of 58407.....
25362	9621	Balance Wheel Ball, size $\frac{3}{16}$ in.....
122303	—	" " " Ring.....
122304	4493	" " " " 122303 with eighteen 25362.....
122306	4493	Balance Wheel Ball Washer (left).....
122469	9616	" " " " (right).....
1402E	4494	" " " " " Screw
11442	896	" " " Friction Washer (paper)...
401E	899	" " " " " Screw....

MACHINE No. 7-37

HAS S. D. A.

OTHERWISE SAME AS NO. 7-26

NO.	PLATE	NAME
58444	9628	Arm Shaft, in place of 19747.....
949E	4494	" " Screw.....
9842	4492	" " " Washer.....
58335	4496	Balance Wheel with two 354c.....
58336	—	" " 58335 with 11442, 122469, two 1402E and four 401E, in place of 19991.....
25362	9621	Balance Wheel Ball, size $\frac{3}{8}$ in.....
122303	—	" " " Ring.....
122304	4493	" " " " 122303 with eighteen 25362.....
122306	4493	Balance Wheel Ball Washer (left).....
122469	9616	" " " " (right).....
1402E	4494	" " " " Screw
11442	896	" " Friction Washer (paper)..
401E	899	" " " " Screw....

Genuine Singer Needles should be used
in Singer Machines.
These Needles and their Containers
are marked with the
Company's Trade Mark "SIMANCO." 1

Needles in Containers marked
"For Singer Machines"
are not Singer made needles. 2

LIST OF PARTS COMPLETE

FOR

MACHINE No. 7-40

FOR STITCHING BUFF WHEELS NOT MORE THAN $\frac{7}{16}$ IN. THICK
AND 18 IN. DIAM. HAS ATTACHMENT UNDERNEATH THE
BED FOR MAKING SPIRAL ROWS OF STITCHING FROM $\frac{1}{4}$
TO $\frac{3}{8}$ INCH APART (IN SIXTEENTHS) AS ORDERED. THIS
MACHINE STITCHES TO WITHIN $1\frac{1}{2}$ INCHES OF THE
CENTER, MAKING THE INNER CIRCLE 3 INCHES IN
DIAMETER. DROP FEED, ALTERNATING PRESSER AND
BELT SHIFTER.

NO.	PLATE	NAME
*19502	—	Arm with 15404 and two 15405.....
8702	887	" Dowel Pin.....
127848	9608	" Oil Cup, for oiling Arm Shaft Front and Back Bearings.....
58565	9608	Arm Oil Tube, for oiling Arm Shaft Inter- mediate Bearing.....
50348E	9619	Arm Screw.....
11878	838	" Shaft.....
11354	830	" " Bushing.....
437c	899	" " " Set Screw.....
11913	825	" Side Cover.....
65D	899	" " " Hinge Screw.....
8708	827	" Spool Pin.....
11241	858	" " " Washer (cloth).....
58407	9631	Balance Wheel and Pulley (tight) with two 354c.....
354c	899	Balance Wheel and Pulley (tight) Set Screw.....
*19924	—	Bed.....
58449	—	" Extension.....
8873	887	" " Dowel Pin.....
123E	901	" " " Screw.....
24131	9608	" Oil Tube with 52045, for oiling Feed Rock Shaft (back) Bearing.....
58549	9608	Bed Oil Tube with 52045, for oiling Feed Lifting and Feed Rock Shaft (front) Bearings.....
52045	9608	Bed Oil Tube Packing (felt).....

NO.	PLATE	NAME
19926	4446	Buff Wheel Clamp Carrier.....
19927	4446	“ “ “ “ Cap.....
691F	905	“ “ “ “ “ Screw.....
19928	—	“ “ “ “ Driving Gear (large) for 19929, 19930 and 58325.....
19929	4447	Buff Wheel Clamp Carrier Driving Gear (large) 19928 with 19931, for 1/4 in. space between rows of stitching.....
58325	4499	Buff Wheel Clamp Carrier Driving Gear (large) 19928 with 58326, for 5/16 in. space between rows of stitching.....
19930	4447	Buff Wheel Clamp Carrier Driving Gear (large) 19928 with 19932, for 3/8 in. space between rows of stitching.....
19931	—	Buff Wheel Clamp Carrier Driving Gear (small) for 19929.....
58326	—	Buff Wheel Clamp Carrier Driving Gear (small) for 58325.....
19932	—	Buff Wheel Clamp Carrier Driving Gear (small) for 19930.....
50204D	4451	Buff Wheel Clamp Carrier Driving Gear Screw.....
19933	—	Buff Wheel Clamp Carrier Driving Gear (intermediate) large.....
19934	4447	Buff Wheel Clamp Carrier Driving Gear (intermediate) large, 19933 with 19935.
19935	—	Buff Wheel Clamp Carrier Driving Gear (intermediate) small.....
50205D	4451	Buff Wheel Clamp Carrier Driving Gear (intermediate) Screw.....
19936	4446	Buff Wheel Clamp Carrier Driving Gear Plate.....
19937	4448	Buff Wheel Clamp Carrier Driving Gear Plate Flanged Bushing.....
2049	853	Buff Wheel Clamp Carrier Driving Gear Plate Flanged Bushing Pin.....
19938	4448	Buff Wheel Clamp Carrier Driving Gear Disengaging Lever.....
19939	—	Buff Wheel Clamp Carrier Driving Gear Disengaging Lever 19938 with 2049 and 19940.....
2049	853	Buff Wheel Clamp Carrier Driving Gear Disengaging Lever Pin.....
19940	4448	Buff Wheel Clamp Carrier Driving Gear Disengaging Lever Shaft.....
1480D	4448	Buff Wheel Clamp Carrier Driving Gear Disengaging Lever Shaft Cap Screw....

NO.	PLATE	NAME
9521	4448	Buff Wheel Clamp Carrier Driving Gear Disengaging Lever Shaft Cap Screw Washer.....
194E	4451	Buff Wheel Clamp Carrier Driving Gear Disengaging Lever Stop Screw.....
58450	9627	Buff Wheel Clamp Carrier Rack.....
58451	9627	“ “ “ “ “ Clamping Plate.....
965E	4451	Buff Wheel Clamp Carrier Rack Screw...
19942	4448	“ “ “ “ Spindle.....
19943	—	“ “ “ “ “ 19942 with 9170 and three 401b.....
19944	4447	Buff Wheel Clamp Carrier Spindle Gear with 462c.....
2049	853	Buff Wheel Clamp Carrier Spindle Gear Pin.....
462c	4451	Buff Wheel Clamp Carrier Spindle Gear Set Screw.....
9170	4443	Buff Wheel Clamp Carrier Spindle Plate with three 9199.....
401D	899	Buff Wheel Clamp Carrier Spindle Plate Screw.....
9199	879	Buff Wheel Clamp Carrier Spindle Plate Spur.....
19945	4446	Buff Wheel Clamp Carrier Stop Plate
691F	905	“ “ “ “ “ “ Screw.....
58396	—	Buff Wheel Clamp Carrier complete, for 3/8 in. space between rows of stitching, Nos. 194E, 1480D, 9521, 19926, 19927, 19930, 19934, 19936, 19937, 19939, 19943, 19944, 50204D, 50205D, two 2049 and four 691F.....
58397	—	Buff Wheel Clamp Carrier complete, for 1/8 in. space between rows of stitching, Nos. 194E, 1480D, 9521, 19926, 19927, 19934, 19936, 19937, 19939, 19943, 19944, 50204D, 50205D, 58325, two 2049 and four 691F.....
58398	—	Buff Wheel Clamp Carrier complete, for 1/4 in. space between rows of stitching, Nos. 194E, 1480D, 9521, 19926, 19927, 19929, 19934, 19936, 19937, 19939, 19943, 19944, 50204D, 50205D, two 2049 and four 691F.....
50201F	4453	Buff Wheel Thumb Screw.....
19628	880	“ “ “ “ Washer.....

NO.	PLATE	NAME
11363	825	Crank Connecting Rod.....
565c	898	" " " Hinge Screw. . . .
1513j	890	" " " " " Nut. . . .
19946	4446	Feed Bar.
307c	898	" " Screw Center.....
56814	—	" " " " 307c with 1513j..
1513j	890	" " " " Nut.....
11367	830	" Cam with two 445c.....
445c	900	" " Set Screw.....
11368	830	" Connecting Link.....
565c	898	" " " Hinge Screw.....
1513j	890	" " " " " Nut..
58430	9618	" Dog, 4 teeth (8 teeth to the inch) for 58433
381E	899	Feed Dog Screw.....
11370	825	" Forked Connection.....
565c	898	" " " Hinge Screw....
1513j	890	" " " " " Nut
19970	4420	" Lifting Rock Shaft with 134E, 2022 and 19967.....
19971	—	Feed Lifting Rock Shaft complete, Nos. 19812 and 19970.....
19812	4421	Feed Lifting Rock Shaft Crank with 346E and 1861.
346E	4453	Feed Lifting Rock Shaft Crank Clamping Screw.....
1861	862	Feed Lifting Rock Shaft Crank Roller and Stud.....
564c	898	Feed Lifting Rock Shaft Screw Center
58384	—	" " " " " " "
1508j	890	564c with 1508j.....
1508j	890	Feed Lifting Rock Shaft Screw Center Nut.....
19967	861	Feed Lifting Rock Shaft Wearing Block
2022	887	" " " " " "
134E	900	Position Pin.....
134E	900	Feed Lifting Rock Shaft Wearing Block Screw.....
11375	830	Feed Regulator.....
568E	898	" " Hinge Screw.....
50322D	4489	" " Thumb Screw.....
58233	4490	" Rock Shaft.....
58234	—	Feed Rock Shaft complete, Nos. 58233 and 58235.....
58235	4491	Feed Rock Shaft Crank with 346E.....
346E	4453	" " " " Clamping Screw
564c	898	" " " Screw Center.....

NO.	PLATE	NAME
58384	—	Feed Rock Shaft Screw Center 564c with 1508j.....
1508j	890	Feed Rock Shaft Screw Center Nut.....
11475	851	Lifting Presser Bar.....
11476	850	" " " Bell Crank.....
166E	899	" " " " " Hinge Cap Screw.....
1851	900	Lifting Presser Bar Bell Crank Lifting Roller with 610E.....
610E	901	Lifting Presser Bar Bell Crank Lifting Roller Screw.....
1518j	907	Lifting Presser Bar Bell Crank Lifting Roller Screw Nut.....
2718	897	Lifting Presser Bar Bell Crank Lifting Roller Screw Nut Washer.....
11478	850	Lifting Presser Bar Bracket with two 145E
145E	899	" " " " Clamping Screw.....
11909	830	Lifting Presser Bar Lifter with 8761 and 8763.....
8760	888	Lifting Presser Bar Lifter Friction Washer
16D	899	" " " " Hinge Screw....
8761	890	" " " " Stop Pin.....
11907	842	" " " Lifting Link.....
166E	899	" " " " " Cap Screw
8763	890	" " " " " Hinge Stud.....
8973	862	Lifting Presser Bar Lifting Link Hinge Stud Pin.....
43267	4492	Lifting Presser Bar Lifting Link Hinge Stud Washer.....
11479	852	Lifting Presser Bar Rock Shaft.....
58578	9618	" " " " " Adjusting Arm with 453c.....
2117	890	Lifting Presser Bar Rock Shaft Adjusting Arm Pin.....
453c	899	Lifting Presser Bar Rock Shaft Adjusting Arm Set Screw.....
11481	851	Lifting Presser Bar Rock Shaft Bracket
2002	853	" " " " " "
4389	853	Dowel Pin (lower).....
4389	853	Lifting Presser Bar Rock Shaft Bracket Dowel Pin (upper).....
123E	901	Lifting Presser Bar Rock Shaft Bracket Screw.....
11484	852	Lifting Presser Bar Rock Shaft Crank with 453c and 1850.....

NO.	PLATE	NAME
2117	890	Lifting Presser Bar Rock Shaft Crank Pin.....
1850	900	Lifting Presser Bar Rock Shaft Crank Roller and Stud.....
453c	899	Lifting Presser Bar Rock Shaft Crank Set Screw.....
11486	850	Lifting Presser Bar Rock Shaft Eccentric Strap with two each 141E and 1528c...
141E	901	Lifting Presser Bar Rock Shaft Eccentric Strap Adjusting Screw.....
1528c	903	Lifting Presser Bar Rock Shaft Eccentric Strap Adjusting Screw Nut.....
608E	900	Lifting Presser Bar Rock Shaft Eccentric Strap Hinge Screw.....
1518J	907	Lifting Presser Bar Rock Shaft Eccentric Strap Hinge Screw Nut.....
11487	853	Lifting Presser Bar Rock Shaft Eccentric Strap Hinge Screw Slide.....
11488	853	Lifting Presser Bar Rock Shaft Eccentric Strap Hinge Screw Slide Washer.....
258E	899	Lifting Presser Bar Screw Bushing.....
19950	4443	" " " Sleeve (intermediate).
11489	852	" " " " (lower).....
11490	852	" " " " (upper).....
11491	—	" " " " 11490 with 11492.....
11492	853	Lifting Presser Bar Sleeve (upper) Cap...
11493	825	" " " Spring (flat).....
58252	4493	" " " Bracket.....
1177E	4494	" " " " Screw
11661	9608	" " " Guide Pin.....
50323D	4489	" " " Regulating Thumb Screw.....
19951	860	Lifting Presser Foot with 211F.....
2049	853	" " " Pin.....
211F	901	" " " Set Screw.....
11380	828	Needle Bar.....
*11539	856	" " Connecting Link.....
566c	898	" " " Hinge Screw
1513J	890	" " " " " " Nut.....
11383	887	Needle Bar Connecting Stud with two 445F.....
19981	—	Needle Bar Connecting Stud 11383 with 11539.....
445F*	900	Needle Bar Connecting Stud Set Screw...

NO.	PLATE	NAME
258E	899	Needle Bar Screw Bushing.....
19702	890	" " Clamp with 680F and 11385.....
*11385	890	" " " Gib.....
680F	862	" " " Thumb Screw.....
58253	—	Oil Cup.....
11917	825	" " Cover.....
9084	889	" " " Hinge Pin.....
2205	887	" " " Latch Spring.....
207F	901	" " " " " Screw.....
8953	874	" " or Wax Stripper (felt).....
11918	888	" " " " Washer (steel) for 11917.....
8482	890	Oil or Wax Stripper Washer (steel) for 58253.....
207F	901	Oil or Wax Stripper Washer Screw.....
58254	4490	Oil Cup complete, Nos. 2205, 8482, 9084, 11917, 11918, 58253, two 8953 and three 207F.....
134E	900	Oil Cup Screw.....
58573	9625	Oscillating Rock Shaft.....
58566	—	Oscillating Rock Shaft complete, Nos. 1508J, 11165, 51237c, 58570, 58573 and 58586.....
58585	9625	Oscillating Rock Shaft Hinge Pin.....
58586	—	" " " " " " 58585 with 1508J.....
1508J	890	Oscillating Rock Shaft Hinge Pin Nut....
51237c	9619	" " " " " Screw Bearing.....
1508J	890	Oscillating Rock Shaft Hinge Pin Screw Bearing Nut.....
11165	897	Oscillating Rock Shaft Oil Pad.....
58567	—	" " " " Tube with 58569.....
58570	9616	Oscillating Rock Shaft Oil Tube complete, Nos. 58567, 58568 and 127848.....
58568	9616	Oscillating Rock Shaft Oil Tube Joint....
127848	9608	" " " " " Oil Cup.
*58569	—	" " " " " Sleeve.
11850	825	" Shaft.....
11393	887	" " Collar with two 453c....
453c	899	" " " Set Screw.....
11848	—	" " Crank.....
19696	4421	Oscillating Shaft Crank complete, Nos. 453c, 1513J, 5868 and 11848.....
40025	4492	Oscillating Shaft Crank Pin.....
453c	899	" " " " Set Screw.....

NO.	PLATE	NAME
9119	4421	Oscillating Shaft Crank Slide Block.....
5868	4421	Oscillating Shaft Crank Slide Block complete, Nos. 190J, 1054c, 5968 and 9119
190J	899	Oscillating Shaft Crank Slide Block Cap Screw.....
5968	887	Oscillating Shaft Crank Slide Block Cap Screw Washer.....
1054c	4421	Oscillating Shaft Crank Slide Block Screw Stud.....
1513J	890	Oscillating Shaft Crank Slide Block Screw Stud Nut.....
11910	7268	Shuttle Bobbin.....
19077	7268	" Cylinder.....
58213	—	" " 19977 with 773F and 19979.....
58527	9621	Shuttle Cylinder Hinge Pin.....
58979	9611	" " Latch.....
12002	7268	" " Pin.....
122419	9621	" " Spring.....
58523	9612	" Frame.....
58524	—	" " 58523 with 12002, 58979 and 122419.....
773F	7268	Shuttle Tension Regulating Screw.....
19979	7268	" " Spring.....
58525	9613	Shuttle (cylinder) 3 in. diam., complete, Nos. 11910, 58213, 58524 and 58527....
11856	830	Shuttle Driver with 453c.....
2117	890	" " Pin.....
453c	899	" " Set Screw.....
11832	830	" Race Back.....
11833	889	" " " Position Pin.....
19577	864	" " " Spring.....
32D	901	" " " Screw.....
11835	—	" " Body.....
11836	825	Shuttle Race complete, Nos. 32D, 11832, 11835, 19577 and two 11833.....
134E	900	Shuttle Race Screw.....
19952	4450	" " Frame with 11838.....
670E	862	" " " Clamping Screw.....
11838	889	" " " Position Pin.....
19953	4450	" " Slide.....
180D	901	" " " Screw.....
11502	851	Tension Bracket and Vibrating Presser Bar Cap with 11424.....
11501	—	Tension Bracket and Vibrating Presser Bar Cap complete, Nos. 122E, 9525, 11502, 11506, 11936, 11937, 12042 and two 190E.....

NO.	PLATE	NAME
159F	901	Tension Bracket and Vibrating Presser Bar Cap Screw (left).....
145E	899	Tension Bracket and Vibrating Presser Bar Cap Screw (right).....
5983	4492	Tension Friction Washer (felt).....
11423	888	" " " (steel).....
1560C	903	" Regulating Thumb Nut.....
8905	887	" " " Washer.....
607E	902	" Screw Stud.....
58598	—	" " " 607E with 1560c.....
122E	901	" " " Clamping Screw.....
8791	888	" Spring.....
11044	897	" Wheel.....
12042	—	Tension (wheel) complete, Nos. 8791, 8905, 11044, 11423, 58598 and two 5983
11424	888	Thread Eyelet for 11502.....
11950	888	" " " 11503.....
11495	9608	" " (side of arm).....
190E	899	" " " " Screw.....
2102	888	" Retaining Disc.....
1560c	903	" " Regulating Thumb Nut
8905	887	" " " " " Washer.....
606E	902	Thread Retaining Screw Stud.....
58597	—	" " " " 606E with 1560c.....
2103	888	Thread Retaining Spring.....
11503	—	Thread Retainer complete, Nos. 2103, 8905, 58597 and two 2102.....
11505	851	Thread Take-up Cam with two 434c.....
8873	887	" " " Pin.....
434c	899	" " " Set Screw.....
58295	—	" " Lever.....
58296	4493	" " " 58295 with 1995....
58320	—	" " " 58296 with 50437D
50437D	4494	" " " Hinge Screw.....
1995	4452	" " " Roller and Screw Stud with 1518J.....
1518J	907	Thread Take-up Lever Roller and Screw Stud Nut.....
11506	853	Thread Take-up Spring.....
11936	852	" " " Regulator Plate
190E	899	" " " " " Adjusting Screw.....
11937	853	Thread Take-up Spring Staple.....
9525	889	" " " " Washer...
58431	—	Throat Plate Body.....

NO.	PLATE	NAME
58432	9618	Throat Plate Needle Plate.....
219F	901	" " " " Screw.....
58433	9618	Throat Plate complete for 58430, Nos. 219F, 58431 and 58432.....
381D	899	Throat Plate Screw.....
*15404	—	Trade Mark.....
15405	4492	" " Rivet.....
19957	4446	Vibrating Presser Bar.....
11509	853	" " " Cushion (rawhide).
233E	901	" " " " Screw.....
11510	850	" " " Hinge Bracket with 145E.....
145E	899	Vibrating Presser Bar Hinge Bracket Adjusting Screw.....
164E	899	Vibrating Presser Bar Hinge Cap Screw
41544	4415	" " " " " " Washer.....
11512	851	Vibrating Presser Bar Spring.....
11939	9608	" " " " Adjusting Staple.....
190E	899	Vibrating Presser Bar Spring Adjusting Staple Screw.....
223E	899	Vibrating Presser Bar Spring Screw.....
10958	9617	" " Foot.....
898E	901	" " " Screw.....
1547J	903	" " " " Nut.....

Genuine Singer Needles should be used
in Singer Machines.
These Needles and their Containers
are marked with the
Company's Trade Mark "SIMANCO." 1

Needles in Containers marked
"For Singer Machines"
are not Singer made needles. 2

LIST OF PARTS COMPLETE FOR MACHINE No. 7-42

FOR STITCHING TENTS, WAGON COVERS, TARPAULINS AND
GENERAL WORK IN CANVAS. TWO NEEDLES, TWO
CYLINDER SHUTTLES. GAUGES FROM 3/4 IN. TO 1 IN.
ALTERNATING PRESSER.

NO.	PLATE	NAME
*58285	—	Arm with 15404 and two 15405.....
8702	887	" Dowel Pin.....
127848	9608	" Oil Cup, for oiling Arm Shaft Front and Back Bearings.....
58565	9608	Arm Oil Tube, for oiling Arm Shaft Inter- mediate Bearing.....
50348E	9619	Arm Screw.....
11353	825	" Shaft.....
11354	830	" " Bushing.....
437C	899	" " " Set Screw.....
11913	825	" Side Cover.....
65D	899	" " Hinge Screw.....
58563	9631	Balance Wheel (two speed) with two 909c
909c	9620	" " Set Screw.....
*19556	—	Bed.....
24131	9608	" Oil Tube with 52045, for oiling Feed Rock Shaft (back) Bearing.....
58549	9608	Bed Oil Tube with 52045, for oiling Feed Lifting and Feed Rock Shaft (front) Bearings.....
52045	9608	Bed Oil Tube Packing (felt).....
58218	4497	Cloth Plate with 58219, 58220 and four 58221.....
*58219	—	Cloth Plate Packing (back).....
*58220	—	" " " (front).....
58221	4492	" " " Rivet.....
389F	901	" " " Screw.....
11363	825	Crank Connecting Rod.....
565c	898	" " " Hinge Screw.....
1513J	890	" " " " " Nut
58327	4493	Feed Bar.....
307c	898	" " Screw Center.....
56814	—	" " " " 307c with 1513J..
1513J	890	" " " " Nut.....
11367	830	" Cam with two 445c.....

From the library of: Diamond Needle Corp

NO.	PLATE	NAME
445C	900	Feed Cam Set Screw.....
11368	830	" Connecting Link.....
565C	898	" " " Hinge Screw.....
1513J	890	" " " " " Nut..
58328	4498	" Dog, 13 teeth (10 teeth to the inch) for 19593.
381E	899	Feed Dog Screw.....
11370	825	" Forked Connection.....
565C	898	" " " Hinge Screw....
1513J	890	" " " " " Nut
19970	4420	" Lifting Rock Shaft with 134E, 2022 and 19967.....
19971	—	Feed Lifting Rock Shaft complete, Nos. 19812 and 19970.....
19812	4421	Feed Lifting Rock Shaft Crank with 346E and 1861.....
346E	4453	Feed Lifting Rock Shaft Crank Clamping Screw.....
1861	862	Feed Lifting Rock Shaft Crank Roller and Stud.....
564C	898	Feed Lifting Rock Shaft Screw Center
58384	—	" " " " " " "
1508J	890	564c with 1508J.....
1508J	890	Feed Lifting Rock Shaft Screw Center Nut.....
19967	861	Feed Lifting Rock Shaft Wearing Block
2022	887	" " " " " " "
134E	900	Position Pin.....
134E	900	Feed Lifting Rock Shaft Wearing Block Screw.....
11375	830	Feed Regulator.....
568E	898	" " Hinge Screw.....
50322D	4489	" " Thumb Screw.....
58233	4490	" Rock Shaft.....
58234	—	Feed Rock Shaft complete, Nos. 58233 and 58235.
58235	4491	Feed Rock Shaft Crank with 346E.....
346E	4453	" " " " Clamping Screw.
564C	898	" " " Screw Center.....
58384	—	" " " " " 564c with 1508J.....
1508J	890	Feed Rock Shaft Screw Center Nut....
26419	4417	Guide (6 in. face).....
254D	902	" Thumb Screw.....
11475	851	Lifting Presser Bar.....
11476	850	" " " Bell Crank.....

NO.	PLATE	NAME
166E	899	Lifting Presser Bar Bell Crank Hinge Cap Screw.....
1851	900	Lifting Presser Bar Bell Crank Lifting Roller with 610E.....
610E	901	Lifting Presser Bar Bell Crank Lifting Roller Screw.....
1518J	907	Lifting Presser Bar Bell Crank Lifting Roller Screw Nut.....
2718	897	Lifting Presser Bar Bell Crank Lifting Roller Screw Nut Washer.....
19910	4445	Lifting Presser Bar Bracket with 145E and 647E.....
647E	4451	Lifting Presser Bar Bracket Clamping Screw (lower).....
145E	899	Lifting Presser Bar Bracket Clamping Screw (upper).....
11909	830	Lifting Presser Bar Lifter with 8761 and 8763.....
8760	888	Lifting Presser Bar Lifter Friction Washer
16D	899	" " " " Hinge Screw...
8761	890	" " " " Stop Pin.....
19911	4445	" " " Lifting Link.....
8763	890	" " " " " Hinge Stud.....
8973	862	Lifting Presser Bar Lifting Link Hinge Stud Pin.....
43267	4492	Lifting Presser Bar Lifting Link Hinge Stud Washer.....
11479	852	Lifting Presser Bar Rock Shaft.....
58578	9618	" " " " " Adjusting Arm with 453c.....
2117	890	Lifting Presser Bar Rock Shaft Adjusting Arm Pin.....
453C	899	Lifting Presser Bar Rock Shaft Adjusting Arm Set Screw.....
58275	7815	Lifting Presser Bar Rock Shaft Bracket
2002	853	" " " " " "
4389	853	Dowel Pin (lower).....
4389	853	Lifting Presser Bar Rock Shaft Bracket Dowel Pin (upper).....
123E	901	Lifting Presser Bar Rock Shaft Bracket Screw.....
11484	852	Lifting Presser Bar Rock Shaft Crank with 453c and 1850.....
2117	890	Lifting Presser Bar Rock Shaft Crank Pin.....

NO.	PLATE	NAME
1850	900	Lifting Presser Bar Rock Shaft Crank Roller and Stud.....
453c	899	Lifting Presser Bar Rock Shaft Crank Set Screw.....
11486	850	Lifting Presser Bar Rock Shaft Eccentric Strap with two each 141E and 1528c...
141E	901	Lifting Presser Bar Rock Shaft Eccentric Strap Adjusting Screw.....
1528c	903	Lifting Presser Bar Rock Shaft Eccentric Strap Adjusting Screw Nut.....
608E	900	Lifting Presser Bar Rock Shaft Eccentric Strap Hinge Screw.....
1518J	907	Lifting Presser Bar Rock Shaft Eccentric Strap Hinge Screw Nut.....
11487	853	Lifting Presser Bar Rock Shaft Eccentric Strap Hinge Screw Slide.....
11488	853	Lifting Presser Bar Rock Shaft Eccentric Strap Hinge Screw Slide Washer.....
258E	899	Lifting Presser Bar Screw Bushing.....
11489	852	" " " Sleeve (lower).....
19912	4443	" " " " (upper).....
19913	—	" " " " " 19912 with 11492.....
11492	853	Lifting Presser Bar Sleeve (upper) Cap...
11493	825	" " " Spring (flat).....
58252	4493	" " " " Bracket.....
1177E	4494	" " " " " Screw.....
11661	9608	" " " " Guide Pin.....
50323D	4489	" " " " Regulating Thumb Screw.....
58276	7821	Lifting Presser Foot with 168E.....
168E	4494	" " " Clamping Screw.....
19732	911	Needle Bar.....
19735	—	Needle Bar complete with adjustable clamps, for 3/4 in. to 1 1/8 in. gauges, Nos. 19732 to 19734 and two 898E.....
*19564	869	Needle Bar Connecting Link.....
566c	898	" " " " Hinge Screw.....
1513J	890	" " " " " " Nut.....
19565	869	Needle Bar Connecting Stud with 129E and 445F.....
58203	—	Needle Bar Connecting Stud 19565 with 19564.....
129E	901	Needle Bar Connecting Stud Clamping Screw.....
445F	900	Needle Bar Connecting Stud Set Screw...

NO.	PLATE	NAME
50343E	4494	Needle Bar Screw Bushing (lower).....
257E	902	" " " " (upper).....
19733	914	" " Clamp (left) with 191F.....
19734	914	" " " (right) with 191F.....
898E	901	" " " Screw.....
191F	899	" " Set Screw.....
58253	—	Oil Cup.....
11917	825	" " Cover.....
9084	889	" " " Hinge Pin.....
2205	887	" " " Latch Spring.....
207F	901	" " " " " Screw.....
8953	874	" or Wax Stripper (felt).....
11918	888	" " " " Washer (steel) for 11917.....
8482	890	Oil or Wax Stripper Washer (steel) for 58253.....
207F	901	Oil or Wax Stripper Washer Screw.....
58254	4490	Oil Cup complete, Nos. 2205, 8482, 9084, 11917, 11918, 58253, two 8953 and three 207F.....
134E	900	Oil Cup Screw.....
58573	9625	Oscillating Rock Shaft.....
58566	—	Oscillating Rock Shaft complete, Nos. 1508J, 11165, 51237c, 58570, 58573 and 58586.....
58585	9625	Oscillating Rock Shaft Hinge Pin.....
58586	—	" " " " " 5 8 5 8 5 with 1508J.....
1508J	890	Oscillating Rock Shaft Hinge Pin Nut....
51237c	9619	" " " " " Screw Bearing.....
1508J	890	Oscillating Rock Shaft Hinge Pin Screw Bearing Nut.....
11165	897	Oscillating Rock Shaft Oil Pad.....
58567	—	" " " " " Tube with 58569.....
58570	9616	Oscillating Rock Shaft Oil Tube complete, Nos. 58567, 58568 and 127848.....
58568	9616	Oscillating Rock Shaft Oil Tube Joint....
127848	9608	" " " " " Oil Cup
*58569	—	" " " " " Sleeve...
19567	863	" Shaft.....
11848	—	" Crank.....
19696	4421	Oscillating Shaft Crank complete, Nos. 453c, 1513J, 5868 and 11848.....
40025	4492	Oscillating Shaft Crank Pin.....
453c	899	" " " Set Screw.....

NO.	PLATE	NAME
9119	4421	Oscillating Shaft Crank Slide Block.....
5868	4421	Oscillating Shaft Crank Slide Block complete, Nos. 190j, 1054c, 5968 and 9119
190j	899	Oscillating Shaft Crank Slide Block Cap Screw.....
5968	887	Oscillating Shaft Crank Slide Block Cap Screw Washer.....
1054c	4421	Oscillating Shaft Crank Slide Block Screw Stud.....
1513j	890	Oscillating Shaft Crank Slide Block Screw Stud Nut.....
11910	833	Shuttle (inside) Bobbin.....
58512	9611	" " Cylinder.....
58513	—	" " " 58512 with 774F and 58515.....
8961	833	Shuttle (inside) Cylinder Hinge Pin.....
58979	9611	" " " Latch.....
12002	833	" " " " Pin.....
11854	833	" " " " Spring....
590D	901	" " " " " Screw
19573	9614	" " " Frame.....
58514	—	" " " 19573 with 590D, 11854, 12002 and 58979.....
774H	4494	Shuttle (inside) Tension Regulating Screw
58515	9611	" " " Spring.....
58516	9611	Shuttle (cylinder) inside, 3 in. diam., complete, Nos. 8961, 11910, 58513 and 58514
11910	833	Shuttle (outside) Bobbin.....
58517	9615	" " " Cylinder.....
58518	—	" " " 58517 with 774F and 58520.....
8961	833	Shuttle (outside) Cylinder Hinge Pin.....
58979	9611	" " " Latch.....
12002	833	" " " " Pin.....
11854	833	" " " " Spring
590D	901	" " " " " "
		Screw.....
19574	9614	Shuttle (outside) Frame.....
58519	—	" " " 19574 with 590D, 11854, 12002 and 58979.....
774H	4494	Shuttle (outside) Tension Regulating Screw.....
58520	9615	Shuttle (outside) Tension Spring.....
58521	9615	Shuttle (cylinder) outside, 3 in. diam., complete, Nos. 8961, 11910, 58518 and 58519.....
19572	864	Shuttle Driver with 445c.....

NO.	PLATE	NAME
58277	4492	Shuttle Driver Pin.....
445c	900	" " Set Screw.....
19575	864	" Race Back (inside).....
19576	864	" " " (outside).....
11833	889	" " " Position Pin.....
19577	864	" " " Spring.....
32D	901	" " " Screw.....
19578	864	" " " Body.....
19579	—	Shuttle Race complete, Nos. 19575, 19576, 19578, two each 32D, 19577 and four 11833.....
58277	4492	Shuttle Race Dowel Pin.....
123E	901	" " Screw.....
58278	7815	Tension Bracket and Vibrating Presser Bar Cap.....
145E	899	Tension Bracket and Vibrating Presser Bar Cap Screw.....
11241	858	Tension Friction Washer (cloth) large....
8879	887	" " " " small....
19684	913	" " " (steel).....
1535E	903	" Regulating Thumb Nut.....
8787	890	" " " Washer
710E	4451	" Screw Stud.....
58599	—	" " " 710E with 1535E.....
19685	913	" " " Flange.....
19686	913	" Spring.....
58279	4499	" Thread Guard.....
690E	4451	" " " Screw.....
41544	4415	" " " " Washer....
58795	4499	" Wheel.....
19889	—	Tension (wheel) complete, Nos. 8787, 11241, 19684 to 19686, 58599 and two each 8879 and 58795.....
19689	914	Thread Eyelet (double) top of arm.....
166E	899	" " " Screw.....
11495	9608	" " (side of arm).....
190E	899	" " " " " Screw.....
2102	888	" Retaining Disc.....
1560c	903	" " Regulating Thumb Nut
8905	887	" " " " " "
		Washer.....
408E	898	Thread Retaining Screw Stud.....
58600	—	" " " " 408E with 1560c, for 11426.....
686E	902	Thread Retaining Screw Stud.....
58590	—	" " " " 686E with 1560c, for 11041.....

NO.	PLATE	NAME
2103	888	Thread Retaining Spring.....
11425	836	" " Thread Eyelet.....
11426	—	Thread Retainer (long stud) complete, Nos. 2103, 8995, 58600 and two 2102...
11041	—	Thread Retainer (short stud) complete, Nos. 2103, 8905, 58590 and two 2102...
11505	851	Thread Take-up Cam with two 434c.....
8873	887	" " " Pin.....
434c	899	" " " Set Screw.....
58301	—	" " " Lever.....
58302	7815	" " " 58301 with 1995..
58316	—	" " " 58302 with 50437D
50437D	4494	" " " Hinge Screw.....
1995	4452	" " " Roller and Screw Stud with 1518j.....
1518j	907	Thread Take-up Lever Roller and Screw Stud Nut.....
19690	914	Thread Take-up Spring.....
58280	4499	" " " Bracket.....
207E	901	" " " Screw...
50166E	4499	" " " Eyelet.....
58281	4499	" " " Lever with 50166E
11431	888	" " " Regulator Plate
190E	899	" " " " "
		Screw.....
19693	914	Thread Take-up Spring Washer.....
19591	—	Throat Plate Body.....
19997	—	" " Needle Hole Strip (left)....
19592	868	" " " " " (right)...
401D	899	" " " " " Screw...
19593	868	Throat Plate complete, for 58328, Nos. 19591, 19592, 19997 and four 401D.....
381D	899	Throat Plate Screw.....
*15404	—	Trade Mark.....
15405	4492	" " Rivet.....
58282	7815	Vibrating Presser Bar.....
19920	4445	" " " Hinge Bracket with 145E.....
145E	899	Vibrating Presser Bar Hinge Bracket Ad- justing Screw.....
23F	4451	Vibrating Presser Bar Hinge Screw.....
11512	851	" " " Spring.....
208E	4451	" " " " Screw.....
19921	4443	" " " " Stop.....
207E	901	" " " " " Screw..
58283	7821	" " " Foot.....
690E	4451	" " " Screw.....
1654c	903	" " " " Nut.....

LIST OF PARTS COMPLETE

FOR

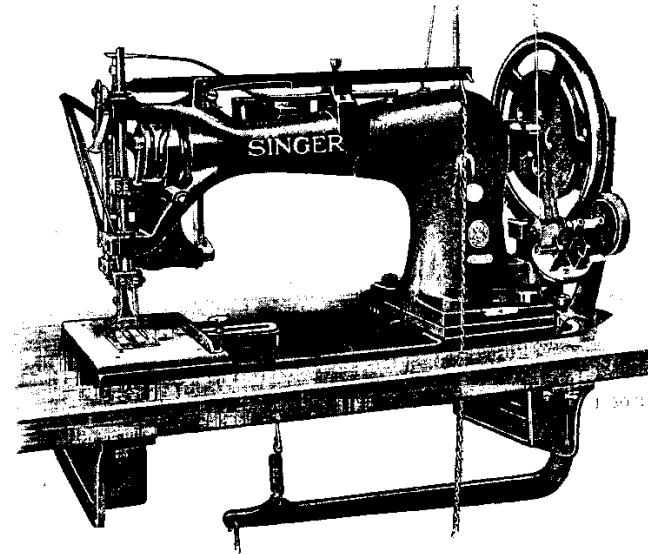

MACHINE No. 7-43

FOR STITCHING TARPULINS AND GENERAL WORK IN CANVAS.
TWO NEEDLES, TWO CYLINDER SHUTTLES. GAUGES
FROM 1 IN. TO 1½ INCHES. INDEPENDENTLY ADJUST-
ABLE UPPER AND UNDER FEEDS. LIFT OF PRESSER FOOT
½ IN. FOOT LIFTER AND S. D. A.

NO.	PLATE	NAME
*58339	—	Arm with 15404 and two 15405.....
19785	914	" Dowel Pin.....
*19887	—	" Packing Plate.....
68350	9608	" Oil Cup, for oiling Arm Shaft Front and Back Bearings.....
58548	9608	Arm Oil Tube, for oiling Arm Shaft Inter- mediate Bearing.....
50347E	4489	Arm Screw.....
43263	4492	" " Washer.....
58588	4495	" Shaft.....

NO.	PLATE	NAME
11354	830	Arm Shaft Bushing.....
437c	899	" " " Set Screw.....
949E	4494	" " " Screw.....
9842	4492	" " " Washer.....
19668	911	" Side Cover.....
65D	899	" " " Hinge Screw.....
58335	4496	Balance Wheel with two 354c.....
58336	—	" " 58335 with 11442, 122469, two 1402E and four 401E.....
25362	9621	Balance Wheel Ball, size $\frac{3}{8}$ in.....
122303	—	" " " Ring.....
122304	4493	" " " " 122303 with eighteen 25362.....
122306	4493	Balance Wheel Ball Washer (left).....
122469	9616	" " " " (right).....
1402E	4494	" " " " " Screw
11442	896	" " " Friction Washer (paper) ..
401E	899	" " " " " Screw....
354c	899	" " " Set Screw.....
*19756	—	Bed.....
24131	9608	" Oil Tube with 52045, for oiling Feed Rock Shaft (back) Bearing.....
58549	9608	Bed Oil Tube with 52045, for oiling Feed Lifting and Feed Rock Shaft (front) Bearings.....
52045	9608	Bed Oil Tube Packing (felt).....
19757	916	Cloth Plate, for 1 in. and $1\frac{1}{8}$ in. gauges..
58340	7835	" " " $1\frac{1}{4}$ in. gauge.....
58341	7835	" " " $1\frac{3}{8}$ in. and $1\frac{1}{2}$ in. gauges
145F	899	" " " Screw.....
19758	4403	Crank Connecting Rod.....
1151c	4452	" " " " Hinge Screw.....
1646J	903	" " " " " Nut
19760	4404	Feed (lower) Bar, for 1 in. and $1\frac{1}{8}$ in. gauges.....
19891	922	Feed (lower) Bar, for $1\frac{1}{4}$ in. to $1\frac{1}{2}$ in. gauges.....
307c	898	Feed (lower) Bar Screw Center.....
56814	—	" " " " " 307c with 1513J.....
1513J	890	Feed (lower) Bar Screw Center Nut..
11367	830	" " " Cam with two 445c....
445c	900	" " " Set Screw.....
11368	830	" " " Connecting Link.....
565c	898	" " " " " H i n g e Screw.....

NO.	PLATE	NAME
1513J	890	Feed (lower) Connecting Link Hinge Screw Nut.....
19761	9609	Feed (lower) Dog, 13 teeth (10 teeth to the inch) for 1 in. gauge, for 58440.....
58342	7836	Feed (lower) Dog, 13 teeth (10 teeth to the inch) for $1\frac{1}{8}$ in. gauge, for 58369...
58343	7838	Feed (lower) Dog, 13 teeth (10 teeth to the inch) for $1\frac{1}{4}$ in. gauge, for 58371...
58344	7839	Feed (lower) Dog, 13 teeth (10 teeth to the inch) for $1\frac{3}{8}$ in. gauge, for 58375...
58345	7840	Feed (lower) Dog, 16 teeth (10 teeth to the inch) for $1\frac{1}{2}$ in. gauge, for 58377...
381E	899	Feed (lower) Dog Screw.....
19762	4403	" " " Forked Connection.....
565c	898	" " " " " H i n g e Screw.....
1513J	890	Feed (lower) Forked Connection Hinge Screw Nut.....
58346	7835	Feed (lower) Lifting Rock Shaft with 134E, 2022 and 19967.....
58347	—	Feed (lower) Lifting Rock Shaft complete, Nos. 19819 and 58346.....
19819	4439	Feed (lower) Lifting Rock Shaft Crank with 346E and 1861.....
346E	4453	Feed (lower) Lifting Rock Shaft Crank Clamping Screw.....
1861	862	Feed (lower) Lifting Rock Shaft Crank Roller and Stud.....
1015c	4453	Feed (lower) Lifting Rock Shaft Screw Center (left).....
58601	—	Feed (lower) Lifting Rock Shaft Screw Center (left) 1015c with 1503J.....
1503J	903	Feed (lower) Lifting Rock Shaft Screw Center (left) Nut.....
294c	4453	Feed (lower) Lifting Rock Shaft Screw Center (right).....
58594	—	Feed (lower) Lifting Rock Shaft Screw Center (right) 294c with 1503J.....
1503J	903	Feed (lower) Lifting Rock Shaft Screw Center (right) Nut.....
19967	861	Feed (lower) Lifting Rock Shaft Wearing Block.....
2022	887	Feed (lower) Lifting Rock Shaft Wearing Block Position Pin.....
134E	900	Feed (lower) Lifting Rock Shaft Wearing Block Screw.....

144 PARTS FOR MACHINE No. 7-43

NO.	PLATE	NAME
11375	830	Feed (lower) Regulator.....
568E	898	" " " Hinge Screw.....
50322D	4489	" " " Thumb Screw.....
58233	4490	" " Rock Shaft.....
58234	—	Feed (lower) Rock Shaft complete, Nos. 58233 and 58235.....
58235	4491	Feed (lower) Rock Shaft Crank with 346E.....
346E	4453	Feed (lower) Rock Shaft Crank Clamping Screw.....
1015c	4453	Feed (lower) Rock Shaft Screw Center (left).....
58601	—	Feed (lower) Rock Shaft Screw Center (left) 1015c with 1503J.....
1503J	903	Feed (lower) Rock Shaft Screw Center (left) Nut.....
294c	4453	Feed (lower) Rock Shaft Screw Center (right).....
58594	—	Feed (lower) Rock Shaft Screw Center (right) 294c with 1503J.....
1503J	903	Feed (lower) Rock Shaft Screw Center (right) Nut.....
19669	911	Feed (upper) Bar.....
19670	912	" " " Guide Bracket (lower) with 456c, for 19671.....
58348	7841	Feed (upper) Bar Guide Bracket (lower) with 456c, for 58349.....
19671	—	Feed (upper) Bar Guide Bracket (lower) complete, for 1 in. and 1½ in. gauges, Nos. 19670, 19672 and two 190E.....
58349	—	Feed (upper) Bar Guide Bracket (lower) complete, for 1¼ in. to 1½ in. gauges, Nos. 58348, 58350 and two 190E.....
19672	912	Feed (upper) Bar Guide Bracket (lower) Cap for 19671.....
58350	7841	Feed (upper) Bar Guide Bracket (lower) Cap for 58349.....
190E	899	Feed (upper) Bar Guide Bracket (lower) Cap Screw.....
2117	890	Feed (upper) Bar Guide Bracket (lower) Pin.....
456c	9620	Feed (upper) Bar Guide Bracket (lower) Set Screw.....
19673	911	Feed (upper) Bar Guide Bracket (upper) for 1 in. and 1½ in. gauges.....
58351	7842	Feed (upper) Bar Guide Bracket (upper) with 11424, for 1¼ in. to 1½ in. gauges

PARTS FOR MACHINE No. 7-43 145

NO.	PLATE	NAME
159E	901	Feed (upper) Bar Guide Bracket (upper) Screw (back).....
134E	900	Feed (upper) Bar Guide Bracket (upper) Screw (front).....
19674	911	Feed (upper) Bar Hinge Bracket with 145E, 795c and two 445c.....
145E	899	Feed (upper) Bar Hinge Bracket Adjusting Screw.....
19675	911	Feed (upper) Bar Hinge Bracket Guide Plate.....
381E	899	Feed (upper) Bar Hinge Bracket Guide Plate Screw.....
795c	9620	Feed (upper) Bar Hinge Bracket Set Screw (long).....
445c	900	Feed (upper) Bar Hinge Bracket Set Screw (short).....
448c	900	Feed (upper) Bar Hinge Bracket Support Screw.....
1520J	905	Feed (upper) Bar Hinge Bracket Support Screw Nut.....
23D	4451	Feed (upper) Bar Hinge Screw.....
58511	9623	" " Cam with two 445c.....
445c	900	" " " Set Screw.....
19527	845	" " Connecting Link.....
65D	899	" " " " Hinge Screw
19528	865	" " Regulator with 231c and 453c.....
912c	903	Feed (upper) Regulator Adjusting Screw
1596D	903	" " " " " "
		Nut.....
19529	9621	Feed (upper) Regulator Adjusting Screw Sleeve.....
231c	901	Feed (upper) Regulator Adjusting Screw Stop Screw.....
3012	853	Feed (upper) Regulator Pin.....
453c	899	" " " Set Screw.....
19677	910	" " " Shaft.....
11393	887	" " " " Collar with two 453c.....
453c	899	Feed (upper) Regulator Shaft Collar Set Screw.....
11708	846	Feed (upper) Regulator Shaft Driving Crank with 453c and 1804.....
3012	853	Feed (upper) Regulator Shaft Driving Crank Pin.....
1804	899	Feed (upper) Regulator Shaft Driving Crank Roller and Stud.....

146 PARTS FOR MACHINE No. 7-43

NO.	PLATE	NAME
453c	899	Feed (upper) Regulator Shaft Driving Crank Set Screw.....
11698	847	Feed (upper) Shaft.....
19678	912	" " " Crank with 453c, 1518j and 1845.....
2117	890	Feed (upper) Shaft Crank Pin.....
1845	899	" " " " Roller and Screw Stud.....
1518j	907	Feed (upper) Shaft Crank Roller and Screw Stud Nut.....
453c	899	Feed (upper) Shaft Crank Set Screw.....
19532	869	" " " Driving Crank with 453c.....
2117	890	Feed (upper) Shaft Driving Crank Pin.....
453c	899	" " " " " Set Screw.....
58352	7836	Feeding Foot.....
NOTE: When ordering No. 58352 state gauge required.		
690E	4451	Feeding Foot Screw.....
1654c	903	" " " Nut.....
26419	4417	Guide (6 in. face).....
885D	902	" Thumb Screw.....
19535	—	Lifting Presser Bar.....
19536	848	" " " 19535 with 64052.....
19680	910	" " " Bell Crank.....
19681	—	Lifting Presser Bar Bell Crank complete, Nos. 611c, 19540 and 19680.....
19539	—	Lifting Presser Bar Bell Crank Adjusting Link.....
19540	845	Lifting Presser Bar Bell Crank Adjusting Link complete, Nos. 1518j, 1828, 2718 and 19539.....
1828	899	Lifting Presser Bar Bell Crank Adjusting Link Roller with 372c.....
372c	898	Lifting Presser Bar Bell Crank Adjusting Link Roller Screw.....
1518j	907	Lifting Presser Bar Bell Crank Adjusting Link Roller Screw Nut.....
2718	897	Lifting Presser Bar Bell Crank Adjusting Link Roller Screw Nut Washer.....
611c	905	Lifting Presser Bar Bell Crank Adjusting Link Screw.....
19682	913	Lifting Presser Bar Bell Crank Connecting Stud with 445c and 523c.....
523c	901	Lifting Presser Bar Bell Crank Connecting Stud Set Screw (large).....

PARTS FOR MACHINE No. 7-43 147

NO.	PLATE	NAME
445c	900	Lifting Presser Bar Bell Crank Connecting Stud Set Screw (small).....
51260D	9619	Lifting Presser Bar Bell Crank Hinge Screw.....
51609E	9620	Lifting Presser Bar Bell Crank Hinge Screw Nut.....
11909	830	Lifting Presser Bar Lifter with 8761 and 8763.....
8760	888	Lifting Presser Bar Lifter Friction Washer
16D	899	" " " " Hinge Screw...
8761	890	" " " " Stop Pin.....
19683	913	" " " Lifting Link.....
8763	890	" " " " " H i n g e Stud.....
8973	862	Lifting Presser Bar Lifting Link Hinge Stud Pin.....
43267	4492	Lifting Presser Bar Lifting Link Hinge Stud Washer.....
257E	902	Lifting Presser Bar Screw Bushing (lower)
913E	903	" " " " " (upper)
11031	863	" " " Spring (flat).....
58252	4493	" " " Bracket.....
1177E	4494	" " " " " Screw
11661	9608	" " " " Guide Pin.....
50323D	4489	" " " " Regulating Thumb Screw.....
19732	911	Needle Bar for 19735.....
58353	7842	" " " 58354.....
19735	—	Needle Bar complete with adjustable clamps, for 1 in. to 1½ in. gauges, Nos. 19732 to 19734 and two 898E.....
58354	—	Needle Bar complete with adjustable clamps, for 1¼ in. to 1½ in. gauges, Nos. 58353, 58355, 58356 and two 898E
*19564	869	Needle Bar Connecting Link.....
566c	898	" " " " Hinge Screw
1513j	890	" " " " " Nut.....
19565	869	Needle Bar Connecting Stud with 129E and 445F.....
58203	—	Needle Bar Connecting Stud 19565 with 19564.....
129E	901	Needle Bar Connecting Stud Clamping Screw.....
445F	900	Needle Bar Connecting Stud Set Screw...
257E	902	" " Screw Bushing.....

NO.	PLATE	NAME
19733	914	Needle Clamp (left) with 191F, for 19735
58355	7841	" " " with 191F, for 58354
19734	914	" " (right) with 191F, for 19735
58356	7841	" " " with 191F, for 58354
898E	901	" " Screw.....
191F	899	" Set Screw.....
58253	—	Oil Cup.....
11917	825	" " Cover.....
9084	889	" " " Hinge Pin.....
2205	887	" " " Latch Spring.....
207F	901	" " " " Screw.....
8953	874	" or Wax Stripper (felt).....
11918	888	" " " " Washer (steel) for 11917.....
8482	890	Oil or Wax Stripper Washer (steel) for 58253.....
207F	901	Oil or Wax Stripper Washer Screw.....
58254	4490	Oil Cup complete, Nos. 2205, 8482, 9084, 11917, 11918, 58253, two 8953 and three 207F.....
134E	900	Oil Cup Screw.....
58550	9625	Oscillating Rock Shaft (steel).....
58551	—	Oscillating Rock Shaft complete, Nos. 1503J, 11165, 51227c, 58550, 58555 and 58595.....
58552	9625	Oscillating Rock Shaft Hinge Pin.....
58595	—	" " " " " 58552 with 1503J.....
1503J	903	Oscillating Rock Shaft Hinge Pin Nut...
51227c	9619	" " " " " Screw Bearing.....
1503J	903	Oscillating Rock Shaft Hinge Pin Screw Bearing Nut.....
11165	897	Oscillating Rock Shaft Oil Pad.....
58553	—	" " " " Tube with 49191.....
58555	9616	Oscillating Rock Shaft Oil Tube with Joint complete, Nos. 58553, 58554 and 68350.....
58554	9616	Oscillating Rock Shaft Oil Tube Joint....
68350	9608	" " " " " Oil Cup
*49191	—	" " " " " Sleeve...
19769	4402	" Shaft.....
19770	—	" " Crank with 445c.....
19789	4406	Oscillating Shaft Crank complete, Nos. 1508J, 19770 and 19773.....

NO.	PLATE	NAME
8873	887	Oscillating Shaft Crank Pin.....
445c	900	" " " Set Screw.....
19771	4406	" " " Slide Block.....
19773	4406	Oscillating Shaft Crank Slide Block com- plete, Nos. 164E, 1156c, 19771 and 19772
164E	4406	Oscillating Shaft Crank Slide Block Cap Screw.....
19772	4406	Oscillating Shaft Crank Slide Block Cap Screw Washer.....
1156c	4406	Oscillating Shaft Crank Slide Block Screw Stud.....
1508J	890	Oscillating Shaft Crank Slide Block Screw Stud Nut.....
16901	9622	Shuttle (inside) Bobbin.....
43273	7816	" " " Center Pin.....
43274	7817	" " " Cylinder with 43273.....
43286	—	" " " 43274 with 1323F and 8895.....
8777	9621	Shuttle (inside) Cylinder Hinge Pin.....
43239	7816	" " " Latch.....
43236	7816	" " " " Hinge Pin
19869	4423	" " " " Spring....
43240	7817	" " " Frame.....
43255	—	" " " 43240 with 19869, 43236 and 43239.....
1323F	901	Shuttle (inside) Tension Regulating Screw
8895	9622	" " " Spring.....
43275	7816	Shuttle (inside, cylinder) 4 in. diam., com- plete, for 1 in. and 1½ in. gauges, Nos. 8777, 16901, 43255 and 43286.....
16901	9622	Shuttle (inside) Bobbin.....
58357	7843	" " " Cylinder.....
58405	—	" " " 58357 with 1323F and 8895.....
8777	9621	Shuttle (inside) Cylinder Hinge Pin.....
8893	6029	" " " Latch Spring....
330b	3583	" " " " Screw
8894	9609	" " " Frame.....
43250	—	" " " 8894 with 330b and 8893.....
1323F	901	Shuttle (inside) Tension Regulating Screw
8895	9622	" " " Spring.....
58358	7843	Shuttle (inside, cylinder) 4 in. diam., com- plete, for 1¼ in. to 1½ in. gauges, Nos. 8777, 16901, 43250 and 58405.....
16901	9622	Shuttle (outside) Bobbin.....
43273	7816	" " " Center Pin....

NO.	PLATE	NAME
43282	7818	Shuttle (outside) Cylinder with 43273
43287	—	" " " 43282 with 1323F and 8900.....
8777	9621	Shuttle (outside) Cylinder Hinge Pin..
43235	7818	" " " Latch.....
43236	7816	" " " " Hinge Pin.....
19869	4423	Shuttle (outside) Cylinder Latch Spring..
43242	7819	" " Frame.....
43256	—	" " " 43242 with 19869, 43235 and 43236.....
1323F	901	Shuttle (outside) Tension Regulating Screw.....
8900	9622	Shuttle (outside) Tension Spring.....
43283	7818	Shuttle (outside, cylinder) 4 in. diam., complete, for 1 in. and 1½ in. gauges, Nos. 8777, 16901, 43256 and 43287....
16901	9622	Shuttle (outside) Bobbin.....
58359	7844	" " Cylinder.....
58403	—	" " " 58359 with 1323F and 8780.....
8777	9621	Shuttle (outside) Cylinder Hinge Pin...
8778	9621	" " " Latch Spring
330D	3583	" " " " " "
		Screw.....
8779	883	Shuttle (outside) Frame.....
43249	—	" " " 8779 with 330D and 8778.....
1323F	901	Shuttle (outside) Tension Regulating Screw.....
8780	883	Shuttle (outside) Tension Spring.....
58360	7844	Shuttle (outside, cylinder) 4 in. diam., complete, for 1¼ in. to 1½ in. gauges, Nos. 8777, 16901, 43249 and 58403....
19774	4404	Shuttle Driver with 445c, for 1 in. and 1½ in. gauges.....
58361	7845	Shuttle Driver with 445c, for 1¼ in. to 1½ in. gauges.....
8055	860	Shuttle Driver Pin.....
445c	900	" " Set Screw.....
19775	—	" Race Body.....
19776	4408	" " Ring (inside).....
19777	4408	" " " (outside).....
134E	900	" " " Screw.....
19778	4407	Shuttle Race complete, for 1 in. and 1½ in. gauges, Nos. 19775 to 19777 and six 134E.....

NO.	PLATE	NAME
58362	—	Shuttle Race Body.....
58363	7842	" " Ring (inside).....
58364	7842	" " " (outside).....
	134E	" " " Screw.....
58365	7845	Shuttle Race complete, for 1¼ in. to 1½ in. gauges, Nos. 58362 to 58364 and six 134E.....
58277	4492	Shuttle Race Dowel Pin.....
	123E	" " Screw.....
11241	858	Tension Friction Washer (cloth) large....
	8879	" " " " small....
	19684	" " " (steel).....
	1535E	" Regulating Thumb Nut.....
	8787	" " " Washer..
	710E	" Screw Stud.....
58599	—	" " " 710E with 1535E.....
19685	913	" " " Flange.....
19686	913	" Spring.....
19687	913	" Thread Guard.....
	164E	" " " Screw.....
41544	4415	" " " " Washer....
58795	4499	" Wheel.....
19889	—	Tension (wheel) complete, Nos. 8787, 11241, 19684 to 19686, 58599 and two each 8879 and 58795.....
11424	888	Thread Eyelet for 58351.....
19689	914	" " (double) top of arm.....
	166E	" " " Screw.....
2102	888	" Retaining Disc.....
1560c	903	" " Regulating Thumb Nut
8905	887	" " " " "
		Washer.....
408E	898	Thread Retaining Screw Stud.....
58600	—	" " " " 408E with 1560c, for 11426.....
686E	902	Thread Retaining Screw Stud.....
58590	—	" " " " 686E with 1560c, for 11041.....
2103	888	Thread Retaining Spring.....
11425	836	" " Thread Eyelet for 11426
11950	888	" " " " " 11041
11426	—	Thread Retainer (long stud) complete, Nos. 2103, 8905, 58600 and two 2102..
11041	—	Thread Retainer (short stud) complete, Nos. 2103, 8905, 58590 and two 2102..
11428	827	Thread Take-up Cam with two 434c.....
8873	887	" " " Pin.....

NO.	PLATE	NAME
434c	899	Thread Take-up Cam Set Screw.....
58303	—	“ “ Lever with two 9219....
58304	7815	“ “ “ 58303 with 1995....
58312	—	“ “ “ 58304 with 50437D
50437D	4494	“ “ “ Hinge Screw.....
1995	4452	“ “ “ Roller and Screw Stud with 1518r.....
1518r	907	Thread Take-up Lever Roller and Screw Stud Nut.....
9219	9621	Thread Take-up Lever Thread Eyelet Bushing.....
19690	914	Thread Take-up Spring.....
19614	879	“ “ “ Hook for 19691..
19694	914	“ “ “ “ “ 19675..
19691	914	“ “ “ Lever with 19614 and 19793.....
19692	914	Thread Take-up Spring Lever Regulator
164E	899	“ “ “ “ “ Screw.....
41544	4415	Thread Take-up Spring Lever Regulator Screw Washer.....
19793	914	Thread Take-up Spring Lever Stop Pin...
19693	914	“ “ “ “ Washer....
58439	—	Throat Plate Body.....
58436	9609	“ “ Needle Hole Strip (left)....
58437	—	“ “ “ “ (right)...
742D	9620	“ “ “ “ “ Screw...
58440	9609	Throat Plate complete, for 19761, Nos. 58436, 58437, 58439, and four 742D....
58366	7837	Throat Plate Body.....
58367	7837	“ “ Needle Hole Strip (left)....
58368	7837	“ “ “ “ (right)...
401D	899	“ “ “ “ “ Screw....
58369	7837	Throat Plate complete for 58342, Nos. 58366 to 58368 and four 401D.....
58366	7837	Throat Plate Body.....
58370	7838	“ “ Needle Hole Strip.....
401D	899	“ “ “ “ “ Screw....
58371	7838	Throat Plate complete for 58343, Nos. 58366, two 58370 and four 401D.....
58372	7839	Throat Plate Body.....
58373	7839	“ “ Needle Plate (left).....
58374	7839	“ “ “ “ (right).....
691D	905	“ “ “ “ “ Screw (large)..
401D	899	“ “ “ “ “ (small)..
58375	7839	Throat Plate complete for 58344, Nos. 58372 to 58374 and two each 401D and 691D.....

NO.	PLATE	NAME
58376	7840	Throat Plate Body.....
58373	7839	“ “ Needle Plate (left).....
58374	7839	“ “ “ “ (right).....
691D	905	“ “ “ “ “ Screw (large)..
401D	899	“ “ “ “ “ (small)..
58377	7840	Throat Plate complete for 58345, Nos. 58373, 58374, 58376 and two each 401D and 691D.....
381D	899	Throat Plate Screw.....
*15404	—	Trade Mark.....
15405	4492	“ “ Rivet.....

MACHINE No. 7-44

HAS S. D. A., OTHERWISE SAME AS NO. 7-42

NO.	PLATE	NAME
58329	4495	Arm Shaft, in place of 11353.....
949E	4494	“ “ Screw.....
9842	4492	“ “ “ Washer.....
122301	—	Balance Wheel with two 354c.....
122302	4496	“ “ 122301 with 11442, 122469, two 1402E and four 401E, in place of 58563.....
25362	9621	Balance Wheel Ball, size $\frac{1}{8}$ in.....
122303	—	“ “ “ Ring.....
122304	4493	“ “ “ “ 122303 with eighteen 25362.....
122306	4493	Balance Wheel Ball Washer (left).....
122469	9616	“ “ “ “ (right).....
1402E	4494	“ “ “ “ “ Screw
11442	896	“ “ Friction Washer (paper)..
401E	899	“ “ “ “ “ Screw....

MACHINE No. 7-45

HAS BELT SHIFTER, OTHERWISE SAME AS NO. 7-42

NO.	PLATE	NAME
11878	838	Arm Shaft, in place of 11353.....
58407	9631	Balance Wheel and Pulley (tight) with two 354c, in place of 58563.....

MACHINE No. 7-46

This Machine is the same as No. 7-11
with the following exceptions:

NO.	PLATE	NAME
58383	7835	Arm Shaft, in place of 58330.....
11358	896	Balance Wheel (two speed) with two 354c, in place of 122302.....

MACHINE No. 7-47

HAS S. D. A., OTHERWISE SAME AS NO. 7-10

NO.	PLATE	NAME
58445	9628	Arm Shaft, in place of 11912.....
949E	4494	" " " Screw.....
9842	4492	" " " Washer.....
122301	—	Balance Wheel with two 354c.....
122302	4496	" " " 122301 with 11442, 122469, two 1402E and four 401E, in place of 11517.....
25362	9621	Balance Wheel Ball, size $\frac{3}{8}$ in.....
122303	—	" " " Ring.....
122304	4493	" " " 122303 with eighteen 25362.....
122306	4493	Balance Wheel Ball Washer (left).....
122469	9616	" " " " (right).....
1402E	4494	" " " " Screw
11442	896	" " Friction Washer (paper)..
401E	899	" " " " Screw....

MACHINE No. 7-50

HAS TWO NEEDLES, TWO CYLINDER SHUTTLES, NOS. 43275
AND 43283; GAUGE 1 INCH. CAN BE FURNISHED IN
GAUGES FROM 1 INCH UP TO 1½ INCHES AT AN ADDITION
OF \$55.00 TO THE REGULAR SELLING PRICE OF THE
MACHINE. HAS DROP FEED. ADJUSTABLE PRESSER,
EITHER VIBRATING OR STATIONARY AND BELT SHIFTER.

This Machine is the same as the 7-26
with the following exceptions:

NO.	PLATE	NAME
58387	9629	Cloth Plate, in place of 19757.....

NO.	PLATE	NAME
58446	9629	Feed Bar, in place of 19760.....
58389	9610	" Dog, 13 teeth (10 teeth to the inch) for 58438, in place of 19761.....
58390	9628	Feed Lifting Rock Shaft with 134E, 2022 and 19967, in place of 58346.....
58391	—	Feed Lifting Rock Shaft complete, Nos. 58390 and two 19819, in place of 58347
1015c	4453	Feed Lifting Rock Shaft Screw Center (front) in place of 294c.....
58601	—	Feed Lifting Rock Shaft Screw Center (front) 1015c with 1503J, in place of 58594.....
1503J	903	Feed Lifting Rock Shaft Screw Center (front) Nut.....
58392	9628	Feed Rock Shaft, in place of 58321.....
58393	—	Feed Rock Shaft complete, Nos. 58235 and 58392, in place of 58322.....
58435	—	Throat Plate Body, in place of 58439.....
58438	9610	Throat Plate complete for 58389, Nos. 58435 to 58437 and four 742D, in place of 58440.....
51062D	9620	Throat Plate Screw, in place of 381D.....

MACHINE No. 7-51

HAS S. D. A., OTHERWISE SAME AS NO. 7-50

NO.	PLATE	NAME
58588	4495	Arm Shaft, in place of 19747.....
58335	4496	Balance Wheel with two 354c.....
58336	—	" " " 58335 with 11442, 122469, two 1402E and four 401E, in place of 19991.....
25362	9621	Balance Wheel Ball, size $\frac{3}{8}$ in.....
122303	—	" " " Ring.....
122304	4493	" " " 122303 with eighteen 25362.....
122306	4493	Balance Wheel Ball Washer (left).....
122469	9616	" " " " (right).....
1402E	4494	" " " " Screw
11442	896	" " Friction Washer (paper)..
401E	899	" " " " Screw....

MACHINE No. 7-52

FOR FOOT POWER OR UNDER DRIVER
OTHERWISE SAME AS THE 7-50

NO.	PLATE	NAME
19923	9628	Arm Shaft, in place of 19747.....
11358	896	Balance Wheel (two speed) with two 354c, for Stand, in place of 19991.....
58411	9631	Balance Wheel with two 354c, for Under Driver, in place of 19991.....

MACHINE No. 7-53

HAS S. D. A., OTHERWISE SAME AS NO. 7-40

NO.	PLATE	NAME
58329	4495	Arm Shaft, in place of 11878.....
122301	—	Balance Wheel with two 354c.....
122302	4496	122301 with 11442, 122469, two 1402E and four 401E, in place of 58407.....
25302	9621	Balance Wheel Ball, size $\frac{1}{16}$ in.....
122303	—	“ “ “ Ring.....
122304	4493	“ “ “ “ 122303 with eighteen 25362.....
122306	4493	Balance Wheel Ball Washer (left).....
122469	9616	“ “ “ “ (right).....
1402E	4494	“ “ “ “ “ Screw
11442	896	“ “ Friction Washer (paper)...
401E	899	“ “ “ “ Screw....

MACHINE No. 7-54

FOR STITCHING TARPULINS AND GENERAL WORK IN CANVAS.
TWO NEEDLES, TWO CYLINDER SHUTTLES. GAUGES FROM
1 IN. TO 1½ IN. INDEPENDENTLY ADJUSTABLE UPPER
AND UNDER FEEDS. LIFT OF PRESSER FOOT ½ IN. FOOT
LIFTER AND S. D. A.

This Machine is the same as the 7-43
with the following exceptions:

NO.	PLATE	NAME
58387	9629	Cloth Plate for 58438, in place of 19757..

NO.	PLATE	NAME
58413	9629	Cloth Plate for 58425, 58429, 58457 and 58584, in place of 19757, 58340 and 58341.....
58446	9629	Feed (lower) Bar, in place of 19760 and 19891.....
58389	9610	Feed (lower) Dog, 13 teeth (10 teeth to the inch) for 1 in. gauge, for 58438, in place of 19761.....
58414	9610	Feed (lower) Dog, 13 teeth (10 teeth to the inch) for 1½ in. and 1¼ in. gauges, for 58457 and 58584, in place of 58342 and 58343.....
58415	9624	Feed (lower) Dog, 16 teeth (10 teeth to the inch) for 1¾ in. and 1½ in. gauges, for 58425 and 58429, in place of 58344 and 58345.....
58390	9628	Feed (lower) Lifting Rock Shaft with 134E, 2022 and 19967, in place of 58346.....
58391	—	Feed (lower) Lifting Rock Shaft complete, Nos. 58390 and two 19819, in place of 58347.....
58392	9628	Feed (lower) Rock Shaft, in place of 58233
58393	—	Feed (lower) Rock Shaft complete, Nos. 58235 and 58392, in place of 58234.....
26176	847	Guide (6 in. face) in place of 26419.....
58434	9628	Lifting Presser Bar Spring (flat) in place of 11031.....
58435	—	Throat Plate Body for 58438, in place of 58439.....
58454	—	Throat Plate Body for 58457 and 58584, in place of 58366.....
58422	—	Throat Plate Body for 58425, in place of 58372.....
58426	—	Throat Plate Body for 58429, in place of 58376.....
58583	9610	Throat Plate Needle Hole Strip for 58584, in place of 58370.....
58436	9609	Throat Plate Needle Hole Strip (left) for 58438, in place of 58371.....
58455	9610	Throat Plate Needle Hole Strip (left) for 58457, in place of 58367.....
58423	9624	Throat Plate Needle Hole Strip (left) for 58425, in place of 58373.....
58427	9624	Throat Plate Needle Hole Strip (left) for 58429, in place of 58373.....
58437	—	Throat Plate Needle Hole Strip (right) for 58438.....

NO.	PLATE	NAME
58456	---	Throat Plate Needle Hole Strip (right) for 58457, in place of 58368.....
58424	---	Throat Plate Needle Hole Strip (right) for 58425, in place of 58374.....
58428	---	Throat Plate Needle Hole Strip (right) for 58429, in place of 58374.....
742D	9620	Throat Plate Needle Hole Strip Screw for 58438, 58457 and 58584.....
691D	905	Throat Plate Needle Hole Strip Screw for 58425 and 58429, in place of 401F.....
58438	9610	Throat Plate complete, for 1 in. gauge, for 58389, Nos. 58435 to 58437 and four 742D, in place of 58440.....
58457	9610	Throat Plate complete, for 1½ in. gauge, for 58414, Nos. 58454 to 58456 and four 742D, in place of 58369.....
58584	9610	Throat Plate complete, for 1¼ in. gauge, for 58414, Nos. 58454, two 58583 and four 742D, in place of 58371.....
58425	9624	Throat Plate complete, for 1¾ in. gauge, for 58415, Nos. 58422 to 58424 and four 691D, in place of 58375.....
58429	9624	Throat Plate complete, for 1½ in. gauge, for 58415, Nos. 58426 to 58428 and four 691D, in place of 58377.....
51062D	9620	Throat Plate Screw, in place of 381D.....

MACHINE No. 7-55

FOR STITCHING BUFF WHEELS NOT MORE THAN ¾ IN. THICK AND 18 INCHES IN DIAMETER. HAS ATTACHMENT UNDERNEATH THE BED FOR MAKING SPIRAL ROWS OF STITCHING FROM ¼ TO ⅜ IN. APART (IN SIXTEENTHS) AS ORDERED. THIS MACHINE STITCHES TO WITHIN ⅞ INCH OF THE CENTER, MAKING THE INNER CIRCLE 1¼ INCHES IN DIAMETER. DROP FEED. ALTERNATING PRESSER. BELT SHIFTER.

This Machine is the same as the 7-40 with the following exceptions:

NO.	PLATE	NAME
58529	9627	Buff Wheel Clamp Carrier Cap, in place of 19927.....
58530	---	Buff Wheel Clamp Carrier Spindle 19942 with 58531 and three 401D, in place of 19943.....

NO.	PLATE	NAME
58532	9608	Buff Wheel Clamp Carrier Spindle Screw Stud.....
58533	9616	Buff Wheel Clamp Carrier Spindle Screw Stud Thumb Nut with two 58534 and four 1161E, in place of 50201F.....
58534	9021	Buff Wheel Clamp Carrier Spindle Screw Stud Thumb Nut Spring.....
1161E	9620	Buff Wheel Clamp Carrier Spindle Screw Stud Thumb Nut Spring Screw.....
58535	9616	Buff Wheel Clamp Carrier Spindle Screw Stud Thumb Nut Washer.....
58531	9616	Buff Wheel Clamp Carrier Spindle Plate with three 9199, in place of 9170.....
58536	---	Buff Wheel Clamp Carrier complete, for ⅝ in. space between rows of stitching, Nos. 194E, 1480D, 9521, 19926, 19930, 19934, 19936, 19937, 19939, 19944, 50204D, 50205D, 58529, 58530, 58532, 58533, 58535, two 2049 and four 691F, in place of 58396.....
58537	---	Buff Wheel Clamp Carrier complete, for ⅙ in. space between rows of stitching, Nos. 194E, 1480D, 9521, 19926, 19934, 19936, 19937, 19939, 19944, 50204D, 50205D, 58325, 58529, 58530, 58532, 58533, 58535, two 2049 and four 691F, in place of 58397.....
58538	---	Buff Wheel Clamp Carrier complete, for ¼ in. space between rows of stitching, Nos. 194E, 1480D, 9521, 19926, 19929, 19934, 19936, 19937, 19939, 19944, 50204D, 50205D, 58529, 58530, 58532, 58533, 58535, two 2049 and four 691F, in place of 58398.....
58539	9612	Feed Dog, 4 teeth (10 teeth to the inch) for 58543, in place of 58430.....
58540	9617	Lifting Presser Foot with 168E, in place of 19951.....
168E	4494	Lifting Presser Foot Clamping Screw, in place of 211F.....
58541	---	Throat Plate Body, in place of 58431.....
58542	9612	" " Needle Plate, in place of 58432.....
58543	9612	Throat Plate complete for 58539, Nos. 219F, 58541 and 58542, in place of 58433
58544	9621	Vibrating Presser Foot, in place of 19958.

BELT SHIFTER PARTS

FOR 7-4, 7-8, 7-15, 7-18, 7-22, 7-24, 7-32, 7-40,
7-45 AND 7-55 MACHINES

NO.	PLATE	NAME
6439	—	Chain, 36 in. to 45 in., with 56864 and 56865.....

NOTE: When ordering 6439 state length required.

4879	858	Chain Connecting Link.....
11446	890	" Eyelet.....
56864	9608	" Hook (large).....
56865	9608	" " (small).....
11447	874	" Pulley.....
567D	898	" " Screw.....
11940	896	Fork.....
434c	899	" Set Screw.....
11941	896	Frame with 8804 and two 434c.....
8804	892	" Handle.....
11450	828	Guide Rod.....
2117	890	" " Pin.....
58408	9630	Pulley (loose).....
58409	9623	" " Flanged Bushing with two 435c.....
435c	900	Pulley (loose) Flanged Bushing Set Screw.....
11451	828	Slide Rod.....
11453	887	" " Collar with two 448c.....
448c	900	" " Set Screw.....
2117	890	" " Pin.....
11942	828	" " Spring.....
11453	887	" " Collar with two 448c....
448c	900	" " Set Screw.....
4881	609	Treadle.....
4882	858	" Shaft.....
4883	858	" Spring.....
4884	609	" Stand.....
4885	609	Treadle complete, Nos. 4879, 4881 to 4884 and two wood screws 1 in. No. 16.....
11945	—	Belt Shifter complete, Nos. 567D, 4885, 6439, 11446, 11447, 11450, 11451, 11940 to 11942, 58408, 58409 and two each 2117 and 11453.....

BELT SHIFTER PARTS

FOR 7-26 AND 7-50 MACHINES

NO.	PLATE	NAME
6439	—	Chain, 36 in. to 45 in., with 56864 and 56865.....

NOTE: When ordering 6439 state length required.

4879	858	Chain Connecting Link.....
11446	890	" Eyelet.....
56864	9608	" Hook (large).....
56865	9608	" " (small).....
9137	—	" Pulley.....
10D	9619	" " Screw.....
11940	896	Fork.....
434c	899	" Set Screw.....
11941	896	Frame with 8804 and two 434c.....
8804	892	" Handle.....
19992	—	Guide Rod.....
3012	853	" " Pin.....
19993	—	Pulley (loose).....
11459	897	" " Collar with two 448c.....
448c	900	" " Set Screw.....
11451	828	Slide Rod.....
2117	890	" " Pin.....
11454	893	" " Spring.....
11453	887	" " Collar with two 448c....
448c	900	" " Set Screw.....
4881	609	Treadle.....
4882	858	" Shaft.....
4883	858	" Spring.....
4884	609	" Stand.....
4885	609	Treadle complete, Nos. 4879, 4881 to 4884 and two wood screws 1 in. No. 16.....
19994	—	Belt Shifter complete, Nos. 10D, 2117, 3012, 4885, 6439, 9137, 11446, 11451, 11453, 11454, 11459, 11940, 11941 and 19991 to 19993.....

ACCESSORIES

NO.	PLATE	NAME
11361	894	Bed Bracket (left) with wood screws 1 in. No. 16.....
11360	894	Bed Bracket (right) with wood screw 1 in. No. 16.....

NO.	PLATE	NAME
11519	858	Bed Bracket with wood screw 1¼ in. No. 14 R. H., for 7-10 Machine.....
507E	898	Bed Bracket Bolt with 1515E.....
1515E	890	" " " Nut.....
135E	899	" " Screw for 11519.....
120344	4484	Oiler (copper plated) with 120345.....
120345	4484	" Spout, 5 in. long.....
11831	4484	Screw Driver (large).....
26026	4484	" " (small).....
120571	9611	Shuttle Cylinder Opener.....
8908	4484	Wrench for 1520 and 1620.....
8909	4484	" " 353, 523, 609, 1513, 1517, 50323 and 51581.....
8910	4484	Wrench for 338, 611, 1508 and 1596.....
8911	4484	" " 1503.....
21875	4457	" " 1646.....
21876	4457	" " 496.....
23535	4484	" " 346, 1528, 1547 and 1549.....
25200	9623	" " 354 and 909.....

DRIVING ATTACHMENTS

NO.	PLATE	NAME
122301	—	Balance Wheel with two 354c, for 122302
58335	4496	" " " " 354c, for 58336.
122302	4496	" " 122301 with 11442, 122469, two 1402E and four 401E, for 58508....
58336	—	Balance Wheel 58335 with 11442, 122469, two 1402E and four 401E, for 58509 and 58510.....
25362	9621	Balance Wheel Ball, size ⅜ in.....
122303	—	" " " Ring.....
122304	4493	" " " " 122303 with eighteen 25362.....
122306	4493	Balance Wheel Ball Ring Washer (left)..
122469	9616	" " " " " (right)
1402E	4494	" " " " " " Screw.....
11442	896	Balance Wheel Friction Washer (paper)..
401E	899	" " " " " Screw....
354c	899	" " " " " Set Screw.....
8984	827	Brake Block (wood).....
58458	9616	" " Stud.....
1036c	9620	" " " Set Screw.....
11440	896	Friction Pulley, 7 in. diam., 1½ in. face, with 448c and 11441.....

NO.	PLATE	NAME
11441	849	Friction Pulley Center Bearing.....
448c	900	" " " Set Screw.....
58463	9631	Lever with 1036c, for 58464.....
58464	—	" 58463 with 134E, 8984, 8991, 8992, 58458, 58462 and two 497E, for 58508..
58459	9631	Lever with 1036c, for 58460 and 58461...
58460	—	" 58459 with 134E, 8984, 8991, 8992, 58458, 58462 and two 497E, for 58509..
58461	—	Lever 58459 with 134E, 8984, 8991, 8992, 58458, 58465 and two 497E, for 58510..
58462	9630	Lever Bracket for 58460 and 58464.....
58465	9630	" " " 58461.....
497E	900	" " Bolt with 1522E.....
1522E	903	" " " Nut.....
134E	900	" Screw.....
8991	828	" " Washer.....
8992	828	" Spring.....
14785	4454	" " Hook (for machine on top of table).....
19863	4454	Lever Spring Hook (for machine flush with table).....
1520J	905	Lever Spring Hook Nut.....
6055	4454	" " " Washer.....
9091	4480	Shaft Driving Pulley (sectional) 10 in. diam., 1½ in. face, 1⅜ in. bore, with two 597c.....
597c	900	Shaft Driving Pulley Clamping Screw....
126036	9630	Treadle.....
126037	—	" 126036 with 2718R, 50581R and 126038.....
126205	9623	Treadle Bracket (left).....
126207	9621	" " " Hook.....
23258	9621	" " " " Friction Washer.....
126208	9621	Treadle Bracket (left) Hook Rivet.....
126206	—	Treadle Bracket (left) complete, Nos. 23258, 126205, 126207, 126208 and two wood screws 1 in. No. 14.....
126038	9623	Treadle Extension.....
50581R	9620	" " " Screw.....
2718R	897	" " " Washer.....
46681	9623	" Bracket (right).....
60502	—	" " " 46681 with two wood screws 1 in. No. 14.....
60858	9623	Treadle Hanging Hook.....
27639	9629	" Pitman Rod.....
9079	9629	" " " Clamp with 354c....

NO.	PLATE	NAME
354c	899	Treadle Pitman Rod Clamp Screw.....
60626	9629	“ “ complete, Nos. two each 9079 and 27639.....
126211	—	Treadle complete, Nos. 60502, 126037 and 126206.....
126212	—	Treadle and Pitman complete, Nos. 60626, 60858 and 126211.....
58508	—	Driving Attachment complete for 58329 and 58445, for 7-3, 7-7, 7-13, 7-14, 7-17, 7-20, 7-24, 7-29, 7-30, 7-36, 7-44, 7-47 and 7-53 Machines, and for 58330 for for 7-11 Machine, Nos. 1520j, 6055, 9091, 11440, 14785, 58464, 122302, 122304, 122306 and 126212.....
58509	—	Driving Attachment complete for 58334, 58444 and 58588, for 7-37 and 7-43 Machines, Nos. 1520j, 6055, 9091, 11440, 14785, 58336, 58460, 122304, 122306 and 126212.....
58510	—	Driving Attachment complete for 58334 and 58588, for 7-51 and 7-54 Machines, Nos. 1520r, 6055, 9091, 11440, 14785, 58336, 58461, 122304, 122306 and 126212

DRIVING ATTACHMENTS

(OBSOLETE)

NO.	PLATE	NAME
122301	—	Balance Wheel with two 354c, for 122302
58335	4496	“ “ “ “ 354c, for 58336.
122302	4496	“ “ 122301 with 11442, 122469, two 1402E and four 401E, for 58379
58336	—	Balance Wheel 58335 with 11442, 122469, two 1402E and four 401E, for 58380 and 58443.....
25362	9621	Balance Wheel Ball, size $\frac{3}{8}$ in.....
122303	—	“ “ “ Ring.....
122304	4493	“ “ “ “ 122303 with eighteen 25362.....
122306	4493	Balance Wheel Ball Ring Washer (left)...
122469	9616	“ “ “ “ “ (right)
1402E	4494	“ “ “ “ “ “ Screw.....
11442	896	Balance Wheel Friction Washer (paper)..
401E	899	“ “ “ “ “ Screw....
354c	899	“ “ “ “ “ Set Screw.....

NO.	PLATE	NAME
8984	827	Brake Block (wood).....
9D	898	“ “ “ Screw.....
11440	896	Friction Pulley, 7 in. diam., $1\frac{1}{2}$ in. face, with 448c and 11441.....
11441	849	Friction Pulley Center Bearing.....
448c	900	“ “ “ Set Screw.....
19662	906	Lever for 58378.....
58378	—	“ 19662 with 9D, 134E, 8984, 8991, 8992, 19663 and two 497E, for 58379....
58248	4480	Lever for 58286 and 58441.....
58286	—	“ 58248 with 9D, 134E, 8984, 8991, 8992, 19663 and two 497E for 58380....
58441	—	Lever 58248 with 9D, 134E, 8984, 8991, 8992, 58442 and two 497E, for 58443....
19663	906	Lever Bracket for 58286 and 58378.....
58442	9630	“ “ “ 58441.....
497E	900	“ “ “ Bolt with 1522E.....
1522E	903	Lever Bracket Bolt Nut.....
134E	900	“ “ “ Screw.....
8991	828	“ “ “ Washer.....
8992	828	“ “ “ Spring.....
14785	4454	“ “ “ Hook (for machine on top of table).....
19863	4454	Lever Spring Hook (for machine flush with table).....
1520r	905	Lever Spring Hook Nut.....
6055	4454	“ “ “ “ Washer.....
9091	4480	Shaft Driving Pulley (sectional) 10 in. diam., $1\frac{1}{2}$ in. face, $1\frac{1}{8}$ in. bore, with two 597c.....
597c	900	Shaft Driving Pulley Clamping Screw....
126036	9630	Treadle.....
126205	9623	“ “ “ Bracket (left).....
126207	9621	“ “ “ “ Hook.....
23258	9621	“ “ “ “ Friction Washer.....
126208	9621	Treadle Bracket (left) Hook Rivet.....
126206	—	Treadle Bracket (left) complete, Nos. 23258, 126205, 126207, 126208 and two wood screws 1 in. No. 14.....
46681	9623	Treadle Bracket (right).....
60502	—	“ “ “ “ 46681 with two wood screws 1 in. No. 14.....
27637	9629	Treadle Pitman Rod (lower).....
150208	9629	“ “ “ “ “ Spring.....
6055	4454	“ “ “ “ “ Washer
27639	9629	“ “ “ “ “ (upper).....

NO.	PLATE	NAME
9079	9629	Treadle Pitman Rod Clamp with 354c....
354c	899	" " " Screw.....
27640	9629	Treadle Pitman complete, Nos. 2762, 6055, 27637, 27639, 150208 and two 9079.....
2762	4454	Treadle Stop Collar with 362F.....
362F	899	" " " Set Screw.....
126209	—	Treadle complete, Nos. 60502, 126036 and 126206.....
126210	—	Treadle and Pitman complete, Nos. 27640 and 126209.....
58379	—	Driving Attachment complete, for 58329 and 58445, for 7-3, 7-7, 7-13, 7-14, 7-17, 7-20, 7-24, 7-29, 7-30, 7-36, 7-44, 7-47 and 7-53 Machines and for 58330, for 7-11 Machine, Nos. 1520r, 6055, 9091, 11440, 14785, 58378, 122302, 122304, 122306 and 126210.....
58380	—	Driving Attachment complete for 58334, 58444 and 58588, for 7-37 and 7-43 Machines, Nos. 1520r, 6055, 9091, 11440, 14785, 58286, 58336, 122304, 122306 and 126210.....
58443	—	Driving Attachment complete for 58334 and 58588, for 7-51 and 7-54 Machines, Nos. 1520r, 6055, 9091, 11440, 14785, 58336, 58441, 122304, 122306 and 126210.....

BINDER (Adjustable)

FOR 7-10 AND 7-47 MACHINES

NO.	PLATE	NAME
11577	4415	Bed.....
11578	4415	" Spring Guide.....
11579	4415	" " " Cam.....
11882	4415	" " " " Stud.....
7071	4415	" " " " " Washer.....
207F	4415	" " " " " Screw.....
3146	4415	" " " " " Washer.....
11576	857	Binder complete, Nos. 207F, 3146, 7071, 11577 to 11579 and 11882.....
164D	4415	Binder Screw.....
41544	4415	" " " Washer.....

BINDERS ON SHANK

NO.	PLATE	NAME
11369	4416	Feed Dog, 14 teeth (10 teeth to the inch) for 11433, 26793, 28997 and 36181.....
11432	—	Throat Plate Body.....
11434	4416	" " Needle Plate (round needle hole).....
11435	4416	Throat Plate Needle Plate (oblong needle hole).....
219F	901	Throat Plate Needle Plate Screw.....
11433	4416	Throat Plate complete for 11369, Nos. 219F, 11432 and 11434.....
58241	—	Throat Plate complete for 11369, Nos. 219F, 11432 and 11435.....
14597	4416	Vibrating Presser Foot for 26793, 28997 and 36181.....
26793	4410	Binder on Shank, for woven strip, for 7-5 to 7-8 Machines.....
28997	4414	Binder on Shank, to fold top edge only, for carpets, for 7-6 Machine.....
36181	4410	Binder on Shank, to turn in both edges of binding, for binding carpets, for 7-5 to 7-8 Machines.....

CORDER (Adjustable)

FOR BUGGY CUSHIONS

NO.	PLATE	NAME
26795	4413	Cord Guide.....
26796	4413	" " Arm with 26798 and three 6037.....
1044D	4451	Cord Guide Arm Hinge Screw.....
26797	4413	" " Bed.....
26798	4413	" " Bracket.....
6037	889	" " " Rivet.....
190E	899	" " Screw.....
26799	4413	Cord complete, Nos. 190E, 1044D and 26795 to 26797.....
14592	922	Vibrating Presser Bar.....
26509	4413	" " Foot for 7-5 to 7-8 Machines.....

NOTE: Presser Foot is used with, but not included
in No. 26799

GUIDE (Adjustable)

FOR TRACES, FOR 7-10 AND 7-47 MACHINES

NO.	PLATE	NAME
19653	908	Guide Body.....
19654	908	" Slide.....
19655	908	" " Clamping Plate.....
86D	4451	" " " " Screw.....
283D	902	" " " " Thumb Screw
19656	908	Guide (adjustable) complete, Nos. 283D, 19653 to 19655 and two 86D.....
254D	902	Guide Thumb Screw.....
19657	908	Shuttle Race Slide (back) for 19656.....

GUIDE (Adjustable)

FOR ROUND LINES, FOR 7-14, 7-20 AND 7-35 MACHINES

NO.	PLATE	NAME
19723	908	Guide Body.....
19724	908	" Slide.....
19655	908	" " Clamping Plate.....
86D	4451	" " " " Screw.....
283D	902	" " " " Thumb Screw
19725	908	Guide (adjustable) complete, Nos. 283D, 19655, 19723, 19724 and two 86D.....
254D	902	Guide Thumb Screw.....
19657	908	Shuttle Race Slide (back) for 19725.....

HEMMER ON SHANK

NO.	PLATE	NAME
26787	4409	Hemmer on Shank, for canvas coal bags, for 7-7 Machine.....

HEMMER ON SLIDE

NO.	PLATE	NAME
120147	7826	Hemmer on Slide 120148 with two 50027D, for heavy duck, for 7-22 and 7-36 Ma- chines.....
50027D	4494	Hemmer Screw.....
120148	—	" Slide.....
120146	—	Cloth Plate for 120147.....

LAP SEAM FELLERS

NO.	PLATE	NAME
26794	4412	Lap Seam Feller (left hand) on Shank, to fold top only, for 7-1 to 7-8 Machines..
26789	4410	Lap Seam Feller on Shank for 7-22, 7-26, 7-36 and 7-37 Machines.....
164D	899	Lap Seam Feller Screw.....
41544	4415	" " " " Washer.....
19718	920	Presser Foot for 26789.....
58328	4498	Feed Dog, 13 teeth (10 teeth to the inch) for 26789, for 7-22 and 7-36 Machines..
19591	—	Throat Plate Body.....
19997	—	" " Needle Hole Strip (left)....
19592	868	" " " " " (right)....
401D	899	" " " " " Screw....
19593	868	Throat Plate complete for 58328, Nos. 19591, 19592, 19997 and four 401D.....
19761	9609	Feed Dog, 13 teeth (10 teeth to the inch) for 26789, for 7-26 and 7-37 Machines..
58439	—	Throat Plate Body.....
58436	9609	" " Needle Hole Strip (left)....
58437	—	" " " " " (right)....
742D	9620	" " " " " Screw....
58440	9609	Throat Plate complete for 19761, Nos. 58436, 58437, 58439 and four 742D.....

LAP SEAM GUIDE

NO.	PLATE	NAME
120163	7826	Lap Seam Guide (left hand, adjustable) on Slide 120164, for tent work, for No. 7 Two-Needle Machines.....
120164	—	Lap Seam Guide Slide.....

PRESSER FOOT

NO.	PLATE	NAME
26510	9617	Vibrating Presser Foot, for side stitching, for 14592, for 7-5 to 7-8 Machines.....

STRIP FOLDERS ON SHANKS

NO.	PLATE	NAME
26786	4409	Strip Folder on Shank, for folding strips for coal bag handles, for 7-7 Machine
26788	4409	Strip Folder on Shank, for folding strips for coal bag handles, for 7-22 and 7-36 Machines.....

BOBBIN WINDERS**BOBBIN WINDER**

(SWINGING AUTOMATIC, RIGHT HAND)

FOR FLAT OR ROUND BELT, FOR 11910

NO.	PLATE	NAME
41439	3579	Base with 458c, 27916 and two 28084....
41398	3583	Bobbin Carrier Key.....
27916	3583	Brake (leather).....
28084	3583	" Rivet.....
41440	3581	Frame.....
41441	3581	" Hinge Pin.....
458c	3583	" " " Set Screw.....
4784	3583	" Oil Pad.....
41442	3581	" Spring.....
41443	3581	Pulley with 155c.....
155c	3583	" Set Screw.....
41444	3579	Spindle with 41398.....
41557	3579	Stop Latch.....
*60630	—	" " 41557 with 2269 and 41446...
41446	3579	" " Hinge Pin.....
2269	3583	" " Pin.....
41447	3581	Tripping Arm with 176E.....
176E	3583	" " Clamping Screw.....
41558	3579	Bobbin Winder, Nos. 41439 to 41444, 41447, 60630, two 4784 and three wood screws 1 in. No. 7.....

THREAD UNWINDER PARTS

27555	7285	Spool Pin.....
41450	3582	" Rest.....
41451	—	" " 41450 with 138E and 27555...
138E	3583	" " Set Screw.....
27557	7833	" Stand with 138E.....
41514	3582	" Weight, 4 in. diam., with 41515....
41515	3583	" " Center Pin.....
2102	3583	Tension Disc.....
1560c	3583	" Regulating Thumb Nut.....
828c	4494	" Screw Stud.....
2103	3583	" Spring.....
5769	3583	" Thread Eyelet.....
17547	4492	" " Guard.....
60608	7285	Thread Guard.....

BOBBIN WINDERS

NO.	PLATE	NAME
27560	7833	Thread Guard Rod, 26 in. long.....
138E	3583	" " " Set Screw.....
330E	3583	" " " Set Screw.....
60609	—	Thread Guard complete, Nos. 330E, 828c, 1560c, 2103, 5769, 17547, 60608 and two 2102.....
41454	3582	Thread Unwinder complete, for one large spool, Nos. 27557, 27560, 41451, 41514, 60609 and three wood screws 1¼ in. No. 12.....
41559	—	Bobbin Winder (swinging automatic, right hand) complete, Nos. 41454 and 41558.....

BOBBIN WINDER

(SWINGING AUTOMATIC, RIGHT HAND)

FOR FLAT OR ROUND BELT, FOR 16901

This Bobbin Winder is the same as 41559
with the following exceptions:

NO.	PLATE	NAME
41550	3580	Base with 458c, 27916 and two 28084, in place of 41439.....
41551	3583	Bobbin Position Pin, in place of 41398....
41552	3580	Spindle, in place of 41444.....
41553	3583	" Collar with 41551 and two 449c..
449c	3583	" " Set Screw.....
41554	3580	Stop Latch, in place of 41557.....
11107	3580	" " Hinge Pin, in place of 41446
41555	3580	Bobbin Winder Nos. 2269, 11107, 41440 to 41443, 41447, 41550, 41552 to 41554, two 4784 and three wood screws 1 in. No. 7, in place of 41558.....
41556	—	Bobbin Winder (swinging automatic right hand) complete Nos. 41454 and 41555, in place of 41559.....

BOBBIN WINDER

(SWINGING AUTOMATIC, RIGHT HAND)

FOR FLAT OR ROUND BELT, FOR 11910

NO.	PLATE	NAME
41439	3579	Base with 458c, 27916 and two 28084....
41398	3583	Bobbin Carrier Key.....

NO.	PLATE	NAME
27916	3583	Brake (leather).....
28084	3583	" Rivet.....
41440	3581	Frame.....
41441	3581	" Hinge Pin.....
458c	3583	" " " Set Screw.....
4784	3583	" Oil Pad.....
41442	3581	" Spring.....
41443	3581	Pulley with 155c.....
155c	3583	" Set Screw.....
41444	3579	Spindle with 41398.....
41557	3579	Stop Latch.....
*60630	—	" " 41557 with 2269 and 41446...
41446	3579	" " Hinge Pin.....
2269	3583	" " Pin.....
41447	3581	Tripping Arm with 176E.....
176E	3583	" " Clamping Screw.....
41558	3579	Bobbin Winder, Nos. 41439 to 41444, 41447, 60630, two 4784 and three wood screws 1 in. No. 7.....

THREAD UNWINDER PARTS

27555	7285	Spool Pin.....
27583	7285	" Rest.....
27556	—	" " 27583 with 138E and two 27555
138E	3583	" " Set Screw.....
27557	7833	" Stand with 138E.....
2102	3583	Tension Disc.....
1560c	3583	" Regulating Thumb Nut.....
828c	4494	" Screw Stud.....
2103	3583	" Spring.....
5769	3583	" Thread Eyelet.....
17547	4492	" " Guard.....
60608	7285	Thread Guard.....
27560	7833	" " Rod, 26 in. long.....
138E	3583	" " " Set Screw.....
330E	3583	" " Set Screw.....
60609	—	Thread Guard complete, Nos. 330E, 828c, 1560c, 2103, 5769, 17547, 60608 and two 2102.....
41823	7285	Thread Unwinder complete, for two large spools, Nos. 27556, 27557, 27560, 60609 and three wood screws 1½ in. No. 12...
41824	—	Bobbin Winder (swinging automatic, right hand) complete, Nos. 41558 and 41823

BOBBIN WINDER

(SWINGING AUTOMATIC, LEFT HAND)

FOR 16901

FOR 58247 AND 58336, FOR 7-37, 7-43, 7-51 AND
7-54 MACHINES

NO.	PLATE	NAME
41894	4485	Base with 449c.....
894E	899	" Screw.....
60213	9621	Bobbin Position Pin.....
41896	4485	Frame.....
41441	4485	" Hinge Pin.....
449c	3583	" " " Set Screw.....
4784	3583	" Oil Pad.....
41897	4485	" Spring.....
43270	4486	Friction Pulley with 43271, two 448c and ten 15405.....
43271	4486	Friction Pulley Ring (leather).....
15405	4492	" " Rivet.....
448c	900	" " Set Screw.....
60214	4486	Spindle.....
454c	4494	" Set Screw.....
60215	4486	" Shaft with 454c and 60213.....
60216	4486	Stop Latch.....
11107	3580	" " Hinge Pin.....
2269	3583	" " Pin.....
41899	4486	Tripping Arm with 176E.....
176E	3583	" " Clamping Screw.....
60217	4485	Bobbin Winder, Nos. 2269, 11107, 41441, 41894, 41896, 41897, 41899, 43270, 60214 to 60216 and two 4784.....
60218	4490	Bracket.....
50124D	4494	" Screw.....
9842	4492	" " Washer.....

THREAD UNWINDER PARTS

27555	7285	Spool Pin.....
27583	7285	" Rest.....
27556	—	" " 27583 with 138E and two 27555
138E	3583	" " Set Screw.....
27557	7833	" Stand with 138E.....
2102	3583	Tension Disc.....
1560c	3583	" Regulating Thumb Nut.....
828c	4494	" Screw Stud.....
2103	3583	" Spring.....

NO.	PLATE	NAME
5769	3583	Tension Thread Eyelet.....
17547	4492	“ “ Guard.....
60608	7285	Thread Guard.....
27560	7833	“ “ Rod, 26 in. long.....
138E	3583	“ “ “ Set Screw.....
330E	3583	“ “ “ Set Screw.....
60609	—	Thread Guard complete, Nos. 330E, 828c, 1560c, 2103, 5769, 17547, 60608 and two 2102.....
41823	7285	Thread Unwinder complete, for two large spools, Nos. 27556, 27557, 27560, 60609 and three wood screws 1¼ in. No. 12..
60219	—	Bobbin Winder (swinging automatic, left hand) complete, Nos. 9842, 41823, 50124D, 60217, 60218 and three 894E..

BOBBIN WINDER

(SWINGING AUTOMATIC, LEFT HAND)

FOR 11910

NO.	PLATE	NAME
41894	4485	Base with 449c.....
894E	899	“ Screw.....
41895	4492	Bobbin Carrier Key.....
41896	4485	Frame.....
41441	4485	“ Hinge Pin.....
449c	3583	“ “ “ Set Screw.....
4784	3583	“ Oil Pad.....
41897	4485	“ Spring.....
43270	4486	Friction Pulley with 43271, two 448c and ten 15405.....
43271	4486	Friction Pulley Ring (leather).....
15405	4492	“ “ “ Rivet.....
448c	900	“ “ “ Set Screw.....
41898	6781	Spindle with 41895.....
41557	6781	Stop Latch.....
*60630	—	“ “ 41557 with 2269 and 41446..
41446	6781	“ “ Hinge Pin.....
2269	3583	“ “ Pin.....
41899	4486	Tripping Arm with 176E.....
176E	3583	“ “ Clamping Screw.....
41900	6781	Bobbin Winder, Nos. 41441, 41894, 41896 to 41899, 43270, 60630 and two 4784...
60259	4490	Bracket.....
50124D	4494	“ Screw.....
9842	4492	“ “ Washer.....

THREAD UNWINDER PARTS

NO.	PLATE	NAME
27555	7285	Spool Pin.....
27583	7285	“ Rest.....
27556	—	“ “ 27583 with 138E and two 27555
138E	3583	“ “ “ Set Screw.....
27557	7833	“ Stand with 138E.....
2102	3583	Tension Disc.....
1560c	3583	“ Regulating Thumb Nut.....
828c	4494	“ Screw Stud.....
2103	3583	“ Spring.....
5769	3583	“ Thread Eyelet.....
17547	4492	“ “ Guard.....
60608	7285	Thread Guard.....
27560	7833	“ “ Rod, 26 in. long.....
138E	3583	“ “ “ Set Screw.....
330E	3583	“ “ “ Set Screw.....
60609	—	Thread Guard complete, Nos. 330E, 828c, 1560c, 2103, 5769, 17547, 60608 and two 2102.....
41823	7285	Thread Unwinder complete, for two large spools, Nos. 27556, 27557, 27560, 60609 and three wood screws 1¼ in. No. 12..
60260	—	Bobbin Winder (swinging automatic, left hand) complete, Nos. 9842, 41823, 41900, 50124D, 60259 and three 894E..

BOBBIN WINDER

(SWINGING AUTOMATIC, LEFT HAND)

FOR 11910

FOR 11438 AND 122302, FOR 7-3, 7-7, 7-11, 7-13, 7-14, 7-17,
7-20, 7-24, 7-30, 7-36, 7-47 AND 7-53 MACHINESThis Bobbin Winder is the same as 60260
with the following exceptions:

NO.	PLATE	NAME
60271	4490	Bracket, in place of 60259.....
60272	—	Bobbin Winder (swinging automatic, left hand) complete, Nos. 9842, 41823, 41900 50124D, 60271 and three 894E.....

BOBBIN WINDER

(SWINGING AUTOMATIC, LEFT HAND)

FOR 16901

FOR 11438 AND 122302, FOR 7-29 MACHINE

This Bobbin Winder is the same as 60219 with the following exceptions:

NO.	PLATE	NAME
60271	4490	Bracket, in place of 60218.....
60273	—	Bobbin Winder (swinging automatic, left hand) complete, Nos. 9842, 41823, 50124D, 60217, 60271 and three 894E..

BOBBIN WINDER

(SWINGING AUTOMATIC, LEFT HAND)

FOR 11910

FOR 11356, FOR 7-2, 7-4, 7-6, 7-8, 7-15, 7-16, 7-18, 7-22, 7-24, 7-32, 7-35, 7-40 and 7-55 MACHINES

This Bobbin Winder is the same as 60260 with the following exceptions:

NO.	PLATE	NAME
60274	4497	Bracket, in place of 60259.....
60275	—	Bobbin Winder (swinging automatic, left hand) complete, Nos. 9842, 41823, 41900, 50124D, 60274 and three 894E..

BOBBIN WINDER

(SWINGING AUTOMATIC, LEFT HAND)

FOR 11910

FOR 11358, FOR 7-1, 7-5, 7-16, 7-34 AND 7-46 MACHINES AND FOR 58249, FOR 7-42 MACHINE

This Bobbin Winder is the same as 60260 with the following exceptions:

NO.	PLATE	NAME
60227	4490	Bracket, in place of 60259.....
60277	—	Bobbin Winder (swinging automatic, left hand) complete, Nos. 9842, 41823, 41900, 50124D, 60227 and three 894E..

BOBBIN WINDER

(SWINGING AUTOMATIC, LEFT HAND)

FOR 16901

FOR 19991, FOR 7-26 AND 7-50 MACHINES

This Bobbin Winder is the same as 60219 with the following exceptions:

NO.	PLATE	NAME
60264	4497	Bracket, in place of 60218.....
60278	—	Bobbin Winder (swinging automatic, left hand) complete, Nos. 9842, 41823, 50124D, 60217, 60264 and three 894E..

BOBBIN WINDER

(SWINGING AUTOMATIC, LEFT HAND)

FOR 16901

FOR 11358, FOR 7-52 MACHINE

This Bobbin Winder is the same as 60219 with the following exceptions:

NO.	PLATE	NAME
60227	4490	Bracket, in place of 60218.....
60279	—	Bobbin Winder (swinging automatic, left hand) complete, Nos. 9842, 41823, 50124D, 60217, 60227 and three 894E..

BOBBIN WINDER (Hand)

FOR MACHINE BED

NO.	PLATE	NAME
11756	—	Belt with 25028.....
25028	889	" Hook.....
11758	858	Frame.....
11759	858	Pulley.....
11760	892	" Driving Wheel.....
8380	893	" " " Handle (wood).....
11762	893	" " " Stud.....
8382	887	" " " " Washer.....
11761	4433	Pulley Driving Wheel Handle complete, Nos. 8380, 8382 and 11762.....

NO.	PLATE	NAME
11763	859	Pulley Driving Wheel Stud.....
2269	889	" " " " Pin.....
11764	862	" " " " Washer.....
11765	858	Spindle.....
11754	855	Bobbin Winder complete, Nos. 2269, 11756, 11758 to 11761 and 11763 to 11765.....
135E	899	Bobbin Winder Screw.....

BOBBIN WINDER (Hand)**FOR WOOD TABLE**

NO.	PLATE	NAME
11768	—	Belt with 25028.....
25028	889	" Hook.....
11769	892	Frame.....
11770	859	Pulley.....
11760	892	" Driving Wheel.....
8380	893	" " " Handle (wood).....
11762	893	" " " Stud.....
8382	887	" " " " Washer.....
11761	4433	Pulley Driving Wheel Handle complete, Nos. 8380, 8382 and 11762.....
11763	859	Pulley Driving Wheel Stud.....
2269	889	" " " " Pin.....
11764	862	" " " " Washer.....
11771	858	Spindle.....
11766	855	Bobbin Winder complete, Nos. 528E, 2269, 11760, 11761, 11763, 11764 and 11768 to 11771.....
528E	859	Bobbin Winder Clamping Screw.....

BOBBIN WINDER**FOR MACHINE ON STAND 25205
OBSOLETE**

NO.	PLATE	NAME
11749	891	Frame.....
2460	897	Friction Ring (rubber).....
11750	891	Spindle.....
2461	891	" Pulley.....
11748	891	Bobbin Winder complete, Nos. 2460, 2461, 11749 and 11750.....
11751	891	Bobbin Winder Spring.....

BOBBIN WINDER**FOR STAND****OBSOLETE**

NO.	PLATE	NAME
11753	891	Frame.....
284D	899	" Thumb Screw.....
2460	897	Friction Ring (rubber).....
11750	891	Spindle.....
2461	891	" Pulley.....
11752	891	Bobbin Winder complete, Nos. 284D, 2460, 2461, 11750 and 11753.....
164E	899	Bobbin Winder Screw.....
41544	4415	" " " Washer.....

BOBBIN WINDER (Automatic)**FOR 11910****OBSOLETE**

NO.	PLATE	NAME
9062	891	Stand with 178F.....
9063	891	" Shaft.....
9064	890	" " Collar.....
9065	891	" " Pulley.....
178F	899	" " Set Screw.....
9066	891	Spindle.....
9067	891	" Frame.....
9068	890	" " Spring.....
7958	890	" " " Pin.....
2448	891	" Pulley.....
9069	891	Stop Latch.....
9070	891	" " Bracket with 178F and 7958..
178F	899	" " " Set Screw.....
24D	899	" " Hinge Screw.....
1541E	890	Tension Regulating Thumb Nut.....
470E	893	" Spool Pin, fixed cone.....
8018	890	" " " Adjustable Cone.....
8019	887	" " " " Spring.....
9071	891	Tension Spool Pin complete, Nos. 470E, 1541E, 8018 and 8019.....
9074	893	Tension Thread Guide Pin.....
9061	891	Bobbin Winder (automatic) complete, Nos. 24D, 2448, 9062 to 9071, 9074 and two wood screws 1 in. No. 7.....

BRIDLE IRON

NO.	PLATE	NAME
41124	4480	Bridle Iron with four each 41125 and 51080E, to set machine flush with table
51080E	9619	Bridle Iron Bolt with 51578E.....
51578E	9620	" " " Nut.....
41125	9621	" " " Washer for 41124.....
60988	9623	" " " Packing.....

FOOT LIFTER PARTS

NO.	PLATE	NAME
13351	—	Chain, length 46 in. to 55 in., with 56864 and 56865.....

NOTE: When ordering 13351, give length required.

4879	858	Chain Connecting Link.....
56864	9608	" Hook (large).....
56865	9608	" " (small).....
19517	4435	Lifting Collar with 453c, for 19521.....
64052	9617	" " " 1149c, for 19648.....
2049	853	" " Pin.....
453c	899	" " Set Screw for 19517.....
1149c	9620	" " " " " 64052.....
58310	4490	" Lever for 19521.....
58311	4490	" " " 19648.....
19519	839	" " Bracket for 19521.....
2117	890	" " " Dowel Pin.....
134E	900	" " " Screw.....
8055	860	" " Hinge Pin.....
19520	860	" " Spring.....
32D	901	" " " Screw.....
4881	609	Treadle.....
4882	858	" Shaft.....
4883	858	" Spring.....
4884	609	" Stand.....
4885	609	Treadle complete, Nos. 4879, 4881 to 4884 and two wood screws 1 in. No. 16.....
19521	—	Foot Lifter complete for 7-11 and 7-46 Machines, Nos. 32D, 134E, 2049, 2117, 4885, 8055, 13351, 19517, 19519, 19520 and 58310.....
19648	—	Foot Lifter complete for 7-14, 7-20, 7-27, 7-30, 7-35 and 7-43 Machines, Nos. 32D, 4885, 8055, 13351, 19520, 58311 and 64052.....

TABLE BELT GUIDE

NO.	PLATE	NAME
58263	7831	Bracket with 448c.....
58264	7831	Pulley.....
58265	7831	" Shaft with 58266 and 58267.....
58266	4492	" " Oil Hole Plug.....
58267	—	" " Packing (wick).....
448c	900	" " Set Screw.....
58268	—	Table Belt Guide complete, for flat belt, for power table, Nos. 58264, 58265, two 58263 and eight wood screws 1½ in. No. 14 R. H. M. F. O. and A.....

THREAD UNWINDERS

THREAD UNWINDER

FOR TWO LARGE SPOOLS OF THREAD
FOR 25207

NO.	PLATE	NAME
60636	7831	Holder with 138E.....
27555	7285	Spool Pin.....
27583	7285	" Rest.....
27556	—	" " 27583 with 138E and two 27555
138E	3583	" " Set Screw.....
2102	3583	Tension Disc.....
1560C	3583	" Regulating Thumb Nut.....
828c	4494	" Screw Stud.....
2103	3583	" Spring.....
5769	3583	" Thread Eyelet.....
17547	4492	" " Guard.....
60608	7285	Thread Guard.....
27693	7833	" " Rod, 37 in. long.....
138E	3583	" " " Set Screw.....
330E	3583	" " " Set Screw.....
60609	—	Thread Guard complete, Nos. 330E, 828c, 1560c, 2103, 5769, 17547, 60608 and two 2102.....
60637	—	Thread Unwinder complete, Nos. 27556, 27693, 60609, 60636 and two wood screws 1¼ in. No. 12.....

THREAD UNWINDER

**FOR THREE LARGE SPOOLS OF THREAD
FOR NO. 7 TWO-NEEDLE MACHINES WHEN SET FLUSH
WITH TABLE**

NO.	PLATE	NAME
27306	7833	Spool Pin.....
27777	7833	" Rest.....
27778	—	" " 27777 with 168B and three 27306.....
168E	4494	Spool Rest Set Screw.....
27557	7833	" Stand with 138E.....
2102	3583	Tension Disc.....
1560c	3583	" Regulating Thumb Nut.....
828c	4494	" Screw Stud.....
2103	3583	" Spring.....
5769	3583	" Thread Eyelet.....
17547	4492	" " Guard.....
60610	7833	Thread Guard.....
27560	7833	" " Rod, 26 in. long.....
138E	3583	" " " Set Screw.....
330E	3583	" " " Set Screw.....
60611	—	Thread Guard complete, Nos. 330E, 828c, 1560c, 2103, 5769, 17547, 60610 and two 2102.....
60612	7833	Thread Unwinder complete, Nos. 27557, 27560, 27778, 60611 and three wood screws 1¼ in. No. 12.....

THREAD UNWINDER

**FOR THREE LARGE SPOOLS OF THREAD
FOR NO. 7 TWO-NEEDLE MACHINES**

**This Thread Unwinder is the same as 60612
with the following exceptions:**

NO.	PLATE	NAME
27693	7833	Thread Guard Rod, 37 in. long, in place of 27560.....
60613	—	Thread Unwinder complete, Nos. 27557, 27693, 27778, 60611 and three wood screws 1¼ in. No. 12.....

OBSOLETE PARTS

NO.	PLATE	NAME
*11351	—	Arm with 11352, 15404 and two each 164E and 15405, for 7-1 to 7-8, 7-13 and 7-15 to 7-18 Machines.....
*11691	—	Arm with 15404 and two 15405, for No. 8, for 7-14, 7-20 and 7-35 Machines.....
*19501	—	Arm with 15404 and two 15405, for No. 8, for 7-1 to 7-8, 7-13, 7-15 to 7-18 and 7-29 Machines.....
*19555	—	Arm with 11559, 11560, 15404 and two each 128E, 612E and 15405, for No. 8, for 7-22, 7-24 and 7-36 Machines.....
*19755	—	Arm with 11559, 15404, 19888 and two each 128E, 612E and 15405, for No. 8, for 7-30 Machine.....
*19898	—	Arm with 15404 and two 15405, for No. 8, for 7-30 Machine.....
496E	4453	Arm Screw for 7-26 and 7-37 Machines...
19699	915	" Shaft for 7-3, 7-7, 7-13, 7-14, 7-17, 7-20, 7-24, 7-29, 7-30 and 7-36 Ma- chines.....
*11352	—	Arm Side Plate for 11351.....
164E	899	" " " Screw for 11351.....
11808	829	Assisting Presser Bar Lifting Link.....
11809	835	" " " " Bracket
11818	836	" " " Spring.....
11807	829	" " Foot.....
11678	906	Balance Wheel with two 354c, for geared machine.....
11438	896	Balance Wheel with two 354c, for 58290..
58290	—	" " 11438 with 11442 and four 401E, for 19664.....
58247	4480	Balance Wheel with two 354c, for 58289..
58289	—	" " 58247 with 11442 and four 401E, for 19862.....
11356	896	Balance Wheel with two 354c, for 7-2, 7-4, 7-6, 7-8, 7-14, 7-16, 7-18, 7-22, 7-32, 7-35, 7-40 and 7-45 Machines.....
8873	887	Balance Wheel Pin for 19664 and 19862..
8937	862	" " " " 11356.....
11883	4457	Bracket for securing machine to power table.....
11773	826	Crank Connecting Rod for 372.....
372c	898	" " " Hinge Screw....
1518r	907	" " " " " Nut.
19861	906	Driving Attachment Lever for 19862.....

NO.	PLATE	NAME
19664	---	Driving Attachment complete for 19699, for 7-3, 7-7, 7-13, 7-14, 7-17, 7-20, 7-24, 7-29, 7-30, 7-36 and 7-44 Machines, and for 11585 for 7-11 Machine, Nos. 1520j, 6055, 8873, 11440, 11864, 14785, 58290, 58378 and 126210.....
19862	---	Driving Attachment complete for 7-37 and 7-43 Machines, Nos. 1520j, 6055, 8873, 11440, 11864, 14785, 58286, 58289 and 126210.....
11864	906	Driving Attachment Shaft Driving Pulley (sectional) 10 in. diam., 1¼ in. face, 1½ in. bore, with two 597c, for 19664 and 19862.....
2875	896	Driving Attachment Treadle.....
19864	4402	Face Plate for 19865.....
19865	---	Face Plate complete for 7-10 and 7-24 Machines, Nos. 190E, 910c, 11867, 11871 to 11873, 11875, 11876, 19864, 19866, 41544, 58581 or 58582 and two 164E....
19884	4402	Face Plate for 19885.....
19885	---	Face Plate complete, for 7-22, 7-26, 7-36 and 7-37 Machines, Nos. 910c, 11867, 11875, 19583, 19590, 19701, 19866, 19884, 19886, 41544, 58579 or 58580 and three 164E.....
19583	869	Face Plate Thread Eyelet for 19885.....
11873	861	" " " Guard for 19865.....
11779	832	Feed Bar for 308.....
11813	832	" " " 308.....
19559	873	" " " 7-22, 7-36 and 7-42 Machines
308c	898	" " Screw Center.....
1517j	890	" " " " Nut.....
11775	835	" Connecting Link for 372.....
372c	898	" " " Hinge Screw.....
1518j	907	" " " " " Nut..
19560	868	" Dog, 13 teeth (10 teeth to the inch) for 7-22, 7-36 and 7-42 Machines, and for 26789 for 7-22 and 7-36 Machines.....
11774	826	Feed Forked Connection for 372.....
11810	826	" " " " 372.....
372c	898	" " " " Hinge Screw.....
1518j	907	" " " " " Nut
11780	826	" Lifting Rock Shaft for 304, for 11781
11821	4402	" " " " " 605, for 11822
11822	---	" " " " " 11821 with 11374

NO.	PLATE	NAME
11781	---	Feed Lifting Rock Shaft complete, Nos. 11780 and 11783.....
11374	830	Feed Lifting Rock Shaft Crank with 453c and 1861, for 11822.....
11783	9617	Feed Lifting Rock Shaft Crank with 453c and 1804, for 11781.....
11785	837	Feed Lifting Rock Shaft Crank with 453c and 1844.....
2117	890	Feed Lifting Rock Shaft Crank Pin.....
1804	899	" " " " Roller and Stud for 11783.....
1844	4452	Feed Lifting Rock Shaft Crank Roller and Stud for 11785.....
453c	899	Feed Lifting Rock Shaft Crank Set Screw for 11374, 11783 and 11785.....
304c	898	Feed Lifting Rock Shaft Screw Center
1513j	890	" " " " " " " Nut.....
11776	831	Feed Regulator for 58E.....
58D	899	" " Hinge Screw.....
11811	826	" Rock Shaft for 11812.....
11819	4402	" " " " 11820.....
11820	---	" " " " 11819 with 11379.....
11812	---	Feed Rock Shaft complete, Nos. 11601 and 11811.....
11379	893	Feed Rock Shaft Crank with 453c, for 11820.....
11601	839	Feed Rock Shaft Crank with 445c, for 11812.....
2117	890	Feed Rock Shaft Crank Pin.....
445c	900	" " " " Set Screw for 11601.....
453c	899	Feed Rock Shaft Crank Set Screw for 11379.....
19676	910	Feed (upper) Cam with two 445c, for 7-30 and 7-43 Machines.....
19518	838	Foot Lifter Lifting Lever for 19521 and 19648.....
11741	---	Gear Cover.....
11744	4435	" Stud Washer.....
19876	922	Lifting Presser Bar for 7-10, 7-22, 7-26, 7-36 and 7-37 Machines.....
11531	881	Lifting Presser Bar Lifter Bracket for 7-10, 7-22, 7-26, 7-36 and 7-37 Machines.....
2117	890	Lifting Presser Bar Lifter Bracket Pin for 11531.....

NO.	PLATE	NAME
11032	846	Lifting Presser Bar Spring Bracket for 7-22, 7-26, 7-29, 7-30, 7-36 and 7-37 Machines.....
11494	850	Lifting Presser Bar Spring Bracket with 12232, for 7-32 and 7-40 Machines.....
381E	899	Lifting Presser Bar Spring Bracket Screw for 11032.....
138E	898	Lifting Presser Bar Spring Bracket Screw for 11494.....
12232	4492	Lifting Presser Bar Spring Guide Pin for 11494.....
609D	902	Lifting Presser Bar Spring Regulating Thumb Screw for 7-10, 7-22, 7-26, 7-30, 7-32, 7-36, 7-37 and 7-40 Machines....
19727	922	Needle Bar for 19731.....
19731	---	Needle Bar complete for No. 7 One-Needle Machines, Nos. 2269, 19727 and 19730
11786	835	Needle Bar Connecting Link for 375c....
375c	4451	" " " " Hinge Screw
1518J	907	" " " " " "
		Nut.....
19728	923	Needle Clamp for 19730.....
19730	923	Needle Clamp (adjustable) complete for 19731, Nos. 172F, 1140F, 19728 and 19729
172F	923	Needle Clamp Adjusting Screw for 19730.
19729	923	" " Body for 19730.....
2269	889	" " Pin for 19731 and 7-22 Machine.....
1140F	923	Needle Clamp Thumb Screw for 19730...
11497	825	Oil Cup for 11921.....
19533	863	" " " 19534.....
11921	825	Oil Cup complete for 7-1 to 7-8, 7-11, 7-13, 7-15 to 7-18, 7-22, 7-24, 7-26, 7-29, 7-32, 7-36, 7-37, 7-40, 7-42 and 7-44 to 7-46 Machines, Nos. 2205, 8482, 9084, 11497, 11917, 11918, two 8953 and three 207F..
19534	863	Oil Cup complete for 7-14, 7-20, 7-27, 7-30 and 7-35 Machines, Nos. 2205, 8482, 9084, 11917, 11918, 19533, two 8953 and three 207F.....
8951	862	Oil Cup Thread Eyelet.....
11919	888	" " " " for 58254.....
11396	831	Oscillating Rock Shaft with 175E, 11399 and two each 11400 and 11401, for 11397
11791	831	Oscillating Rock Shaft for 304.....
11792	831	" " " with 175E, 11399 and two each 11401 and 11793, for 564..

NO.	PLATE	NAME
11824	831	Oscillating Rock Shaft with 175E, 11399 and two each 11400 and 11401, for 605..
11860	831	Oscillating Rock Shaft with 175E, 11399 and two each 11401 and 11793, for 304 and 1804.....
11861	4433	Oscillating Rock Shaft with 175E, 11399 and two each 11401 and 11793, for 304 and 1861.....
11862	4433	Oscillating Rock Shaft with 175E, 11399 and two each 11401 and 11793, for 618 and 1861.....
11841	827	Oscillating Rock Shaft for 11842.....
19768	4404	" " " " 19790.....
11397	---	Oscillating Rock Shaft complete, Nos. 622c, 1508J, 11396 and 58293.....
11842	---	Oscillating Rock Shaft complete for 7-1 to 7-8, 7-10, 7-11, 7-13 to 7-18, 7-20, 7-22, 7-24, 7-29, 7-30, 7-32, 7-35, 7-36, 7-40, 7-42, 7-44 to 7-47, 7-53 and 7-55 Machines, Nos. 622c, 1508J, 11165, 11841 and 58293.....
19790	---	Oscillating Rock Shaft complete for 7-26, 7-37, 7-43, 7-50 to 7-52 and 7-54 Machines, Nos. 654c, 9115, 11165, 19768 and two 1503J.....
11398	827	Oscillating Rock Shaft Hinge Pin for 58293.....
58293	---	Oscillating Rock Shaft Hinge Pin 11398 with 1508J, for 11397 and 11842.....
9115	4433	Oscillating Rock Shaft Hinge Pin for 19790.....
622c	899	Oscillating Rock Shaft Hinge Pin Screw Bearing for 11397 and 11842.....
654c	4453	Oscillating Rock Shaft Hinge Pin Screw Bearing for 19790.....
11399	923	Oscillating Rock Shaft Oil Pad for 11396, 11792, 11824 and 11860 to 11862.....
175E	901	Oscillating Rock Shaft Oil Pad Screw for 11396, 11792, 11824 and 11860 to 11862
564c	898	Oscillating Rock Shaft Screw Center.....
618c	4453	" " " " " "
304c	898	" " " " " "
605c	4453	" " " " " "
1508J	890	" " " " " Nut
		for 564 and 605.....
1513J	890	Oscillating Rock Shaft Screw Center Nut for 304 and 618.....

NO.	PLATE	NAME
11877	914	Thread Take-up Spring (11506 light wire)
11894	914	" " " (11052 light wire)
9046	879	" " " Lever Stop Pin for 19906.....
11843	826	Treadle Extension with 138E.....
138E	898	" " Set Screw for 11843...
11561	859	Vibrating Presser Bar Guide Bracket for 7-10, 7-22, 7-26, 7-36 and 7-37 Machines
2049	853	Vibrating Presser Bar Guide Bracket Pin for 11561.....
2117	890	Vibrating Presser Bar Guide Bracket Pin for 14593, for 7-5 and 7-16 Machines...

FOR MACHINES NOS. 7-1 TO 7-8

11839	836	Feed Dog, 16 teeth (10 teeth to the inch) for 11806.....
11886	904	Feed Dog, 16 teeth (10 teeth to the inch) for 11888.....
11806	836	Throat Plate for 11839.....
11887	—	" " Body for 11888.....
11890	904	" " Needle Plate (oblong needle hole) for 11888.....
11889	904	Throat Plate Needle Plate (round needle hole) for 11888.....
11888	904	Throat Plate complete for 11886, Nos. 219F, 11887 and 11889 or 11890.....

FOR MACHINE NO. 7-4

11448	906	Belt Shifter Fork for 11445.....
11449	906	" .. Frame with 8804 and two 434c, for 11445.....
11457	906	Belt Shifter Pulley (loose) for 11445.....
11456	906	" " " (tight) with two 354c, for 11445.....
354c	899	Belt Shifter Pulley (tight) Set Screw for 11456.....
11454	893	Belt Shifter Slide Rod Spring for 11445..
11445	—	Belt Shifter complete, Nos. 567D, 5668, 5672, 6439, 11446 to 11451, 11454, 11456, 11457, 11459 and two each 2117 and 11453.....
5667	609	Foot Lever for 5668.....
5668	609	" " 5667 with 5669, 5671 and three wood screws 1½ in. No. 16, for 11445.....

NO.	PLATE	NAME
5669	609	Foot Lever Bracket for 5668.....
5671	897	" " Hinge Pin for 5668.....
5672	9617	" " Lifting Spring for 11445.....

FOR MACHINES NOS. 7-5 TO 7-8

11463	851	Lifting Presser Bar Guide Bracket with 159E and 453c.....
11949	839	Vibrating Presser Bar.....
11468	851	" " " Guide Bracket with 448c, for 11469.....
11469	—	Vibrating Presser Bar Guide Bracket complete, Nos. 11468, 11470 and two 190E.....
11470	851	Vibrating Presser Bar Guide Bracket Cap for 11469.....
164E	899	Vibrating Presser Bar Hinge Cap Screw
41544	4415	" " " " " " Washer.....
11473	853	Vibrating Presser Foot.....

FOR MACHINE NO. 7-10

*11628	—	Arm with 11515, 15404 and two each 134E and 15405.....
*11911	—	Arm with 11559, 11560, 15404 and two each 128E, 612E and 15405, for No. 8..
*19960	—	Arm with 11559, 11560, 15404 and two each 128E, 612E and 15405.....
11514	855	Arm Shaft for 11628.....
*11515	—	" Side Plate for 11628.....
134E	900	" " " Screw for 11628.....
11520	854	Face Plate.....
11548	862	" " Thread Eyelet for 11520.....
11369	4416	Feed Dog, 14 teeth (10 teeth to the inch)
11893	4455	" " 14 teeth (10 teeth to the inch) for general work.....
283D	902	Guide Thumb Screw.....
41544	4415	" " " Washer.....
11522	855	Lifting Presser Bar.....
11551	4433	" " " Bell Crank Lifting Cam for 11550.....
2117	890	Lifting Presser Bar Bell Crank Lifting Cam Pin for 11550.....
11529	—	Lifting Presser Bar Lifter for 11530...
11530	856	" " " " 11529 with 11532 and 11533.....

NO.	PLATE	NAME
164E	899	Lifting Presser Bar Lifter Cap Screw
11534	862	" " " " " "
		Washer.....
11535	862	Lifting Presser Bar Lifter Cap Screw
		Washer Steady Pin.....
11532	862	Lifting Presser Bar Lifter Friction Spring
11533	862	" " " " " "
		Stud.....
11868	860	Lifting Presser Bar Lifter Hinge Pin....
11537	889	" " " Spring Adjusting Block
		with 435c.....
11869	860	Lifting Presser Bar Spring Adjusting Block
		with 523c.....
435c	900	Lifting Presser Bar Spring Adjusting Block
		Set Screw for 11537.....
523c	901	Lifting Presser Bar Spring Adjusting Block
		Set Screw for 11869.....
446F	899	Needle Bar Connecting Stud Set Screw...
11898	860	" " Thread Eyelet.....
190E	899	" " " " Screw.....
11574	862	" " " Guard for 11538.....
11542	—	" Clamp with 680F and 11385, for
		11543.....
11543	889	Needle Clamp complete, Nos. 830F, 10107,
		11542 and two 10106.....
10106	889	Needle Clamp Disc for 11543.....
10107	889	" " Spring for 11543.....
830F	901	" " " Screw for 11543....
11387	855	Oil Cup for 11920.....
11920	855	Oil Cup complete, Nos. 2205, 8482, 9084,
		11387, 11917, 11918, two 8953 and three
		207F.....
11879	—	Spool Holder Bracket for 11880.....
11880	855	Spool Holder Bracket complete, Nos.
		11879 and 11881.....
381E	899	Spool Holder Bracket Screw.....
58229	—	" " " for 58230.....
58230	—	Spool Holder Bracket complete, Nos.
		11881 and 58229.....
11545	858	Shuttle Race Slide (right).....
11549	—	Thread Take-up Cam with two 434c, for
		11550.....
11550	854	Thread Take-up Cam 11549 with 2117,
		11551 and two each 159E and 434c....
19754	922	Thread Take-up Lever with 1948 and
		1995.....

NO.	PLATE	NAME
11552	859	Thread Take-up Lever Spring.....
11553	859	" " " " Regulator
		Plate.....
11554	862	Thread Take-up Staple.....
11575	856	Wrench for 611.....
FOR MACHINE NO. 7-11		
11585	838	Arm Shaft.....
19700	915	" " for 11358.....
11592	844	Feed Dog, 17 teeth (12 teeth to the inch)
		for 11638 and 19516.....
19698	4401	Feed Dog, 26 teeth (16 teeth to the inch)
11900	4427	" Forked Connection Friction Spring
		Extension (left).....
19511	861	Feed Reverse Stop Lever Spring Hook...
11946	842	Guide with Ridge.....
11602	840	Knee Lever for 11895.....
11895	840	" " 11602 with 11896.....
11603	838	" " Connecting Rod.....
11604	—	" Plate for 11896.....
11896	840	" " 11604 with 135E, 11605, 11897
		and four 11606, for 11895.....
11605	856	Knee Plate Bracket (left) for 11896....
11897	856	" " " (right) for 11896....
11606	879	" " Rivet for 11896....
135E	899	" " Clamping Screw for 11896....
2117	890	Presser Bar Guide Bracket Pin.....
11637	861	" Foot.....
11625	842	Shuttle Race Ring.....
11613	840	Switch Lever.....
11614	843	" " Bracket.....
11615	—	" " Connecting Rod for 11616..
11616	840	" " " 11615 with
		11621 and 11624.....
11617	843	Switch Lever Connecting Rod Guide.....
11618	843	" " " " " Bracket
11619	843	" " " " " Cap....
11620	843	" " " " " Plate....
11621	889	" " " " " Stop Pin for
		11616.....
11622	886	Switch Lever Spring.....
11623	843	" Ring.....
11624	889	" " Point for 11616.....
11630	843	Thread Take-up Cam with two 434c....
11948	844	Throat Plate 11687 with 11947 and two
		401D.....

NO.	PLATE	NAME
11638	905	Throat Plate complete for 11592, Nos. 11631, 11632 or 11863 and two 401D...
19516	844	Throat Plate complete for 11592, Nos. 19514, 19515 and two 401D.....
11631	—	Throat Plate Body for 11638.....
19514	—	" " " " 19516.....
11687	—	" " " " 11948.....
11632	905	" " Needle Hole Strip for 11638
19515	—	" " " " " " 19516
11863	905	" " " " " (oblong needle hole) for 11638.....
11947	—	Throat Plate Needle Hole Strip with Ridge, for 11948.....
11633	9627	Throat Plate Packing.....

FOR MACHINES NOS. 7-13 AND 7-15

11592	844	Feed Dog, 17 teeth (12 teeth to the inch)
19698	4401	" " 26 teeth (16 teeth to the inch)
11885	4455	" " (double).....
11463	851	Lifting Presser Bar Guide Bracket with 159E and 453c.....
11688	904	Throat Plate complete, Nos. 11687, 11689 and two 401D.....
11687	—	Throat Plate Body for 11688.....
11689	—	" " Needle Hole Strip for 11688
11690	9627	" " Packing.....
11722	—	Vibrating Presser Bar for 19523.....
19523	839	" " " 11722 with 11739 and two 11740.....
11468	851	Vibrating Presser Bar Guide Bracket with 448c, for 11469 and 11724.....
11724	886	Vibrating Presser Bar Guide Bracket complete, Nos. 11468, 11725 and two 190E.....
11469	—	Vibrating Presser Bar Guide Bracket complete, Nos. 11468, 11470 and two 190E.....
11470	851	Vibrating Presser Bar Guide Bracket Cap for 11469.....
11725	886	Vibrating Presser Bar Guide Bracket Cap with 9042, for 11724.....
3012	853	Vibrating Presser Bar Guide Bracket Pin.....
164E	899	Vibrating Presser Bar Hinge Cap Screw
41544	4415	" " " " " " Washer.....

NO.	PLATE	NAME
11728	844	Vibrating Presser Foot.....
191F	899	" " " Screw.....

FOR MACHINES NOS. 7-14 AND 7-20

*11692	—	Arm Side Plate.....
11715	846	Feed Bar.....
11830	845	" " Bracket.....
11716	—	" " Guide Bracket (lower) with 453c for 11717.....
11717	846	Feed Bar Guide Bracket (lower) complete, Nos. 11716, 11718 and two 190E.....
453c	899	Feed Bar Guide Bracket (lower) Set Screw for 11716.....
11718	—	Feed Bar Guide Bracket (lower) Cap with 9042, for 11717.....
9042	890	Feed Bar Guide Bracket (lower) Cap Hook for 11718.....
11719	846	Feed Bar Guide Bracket (upper).....
11048	845	" " Hinge Bracket with 145E, 434c and 445c.....
445c	900	Feed Bar Hinge Bracket Set Screw (short) for 11048.....
9043	9621	Feed Bar Hinge Washer.....
2049	853	" " " " Pin.....
11720	874	" " Spring Bracket with 8077.....
11721	874	" " " Block.....
8077	879	" " " Hook for 11720.....
11694	847	" Cam with two 445c.....
19526	847	" " " 445c.....
11695	846	" Connecting Link.....
11711	884	" Point.....

NOTE: When ordering No. 11711, give stitches to the inch.

11697	846	Feed Regulator with 453c.....
11699	846	" " Shaft Bracket.....
11700	—	" " " Crank with 453c, for 11701.....
11701	884	Feed Regulator Shaft Crank 11700 with 1518J and 1845.....
1845	899	Feed Regulator Shaft Crank Roller and Screw Stud for 11701.....
1518J	907	Feed Regulator Shaft Crank Roller and Screw Stud Nut for 11701.....
453c	899	Feed Regulator Shaft Crank Set Screw for 11700.....

NUMERICAL LIST OF PARTS

NO.	PLATE	NAME
8D	898	Lifting Presser Bar Bell Crank Hinge Screw for 7-24 Machine, obsolete.....
9D	898	Driving Attachment Brake Block Screw for 58286, 58378 and 58441, obsolete...
10D	9619	Belt Shifter Chain Pulley Screw for 19994
16D	899	Lifting Presser Bar Lifter Hinge Screw for 7-5 to 7-8, 7-11, 7-13, 7-15 to 7-18, 7-30, 7-32, 7-40, 7-42 to 7-46 and 7-53 to 7-55 Machines.....
16D	899	Presser Bar Lifter Hinge Screw for 7-1 to 7-4, 7-14, 7-20, 7-29 and 7-35 Machines
23D	4451	Feed (upper) Bar Hinge Screw for 7-43 and 7-54 Machines.....
23F	4451	Vibrating Presser Bar Hinge Screw for 7-32, 7-42, 7-44 and 7-45 Machines.....
24D	899	Bobbin Winder Stop Latch Hinge Screw for 9061, obsolete.....
25F	901	Presser Bar Clutch Hinge Screw for 7-14, 7-20 and 7-35 Machines.....
32D	901	Lifting Lever Spring Screw for 19521 and 19648.....
32D	901	Shuttle Race Back Spring Screw for 11836, 19552, 19579 and 19640.....
58D	899	Feed Regulator Hinge Screw, obsolete....
58D	899	" Reverse Lever Connection Hinge Screw (lower end) for 7-11 and 7-46 Machines.....
58D	899	Feed Reverse Lever Hinge Screw for 7-11 and 7-46 Machines.....
65D	899	Arm Side Cover Hinge Screw for 7-1 to 7-8, 7-10, 7-11, 7-13 to 7-18, 7-20, 7-22, 7-24, 7-26, 7-29, 7-30, 7-32, 7-35 to 7-37, 7-40, 7-42, 7-43 to 7-47 and 7-50 to 7-55 Machines.....
65D	899	Feed Connecting Link Hinge Screw for 7-14, 7-20 and 7-35 Machines.....
65D	899	Feed (upper) Connecting Link Hinge Screw for 7-30, 7-43 and 7-54 Machines.....
65D	899	Feed Reverse Lever Connection Hinge Screw (switch clutch end) for 7-11 and 7-46 Machines.....
65D	899	Lifting Presser Bar Lifting Link Hinge Screw for 7-30 Machine.....
65D	899	Presser Bar Lifting Link Hinge Screw for 7-14, 7-20 and 7-35 Machines.....

Genuine Singer Needles should be used
in Singer Machines.
These Needles and their Containers
are marked with the
Company's Trade Mark "SIMANCO." 1

Needles in Containers marked
"For Singer Machines"
are not Singer made needles. 2

NO.	PLATE	NAME
65D	899	Switch Clutch Lever Hinge Screw for 7-11 and 7-46 Machines.....
82D	905	Feed Reverse Stop Lever Spring Screw for 7-11 and 7-46 Machines.....
86D	4451	Guide Slide Clamping Plate Screw for 19656 and 19725.....
96D	901	Shuttle Race Cap Screw for 19552.....
96D	901	Strip Guide Screw for 7-11 and 7-46 Machines.....
122E	901	Tension Screw Stud Clamping Screw for 11501.....
123E	901	Bed Extension Screw for 7-24, 7-32, 7-40, 7-53 and 7-55 Machines.....
123E	901	Lifting Presser Bar Rock Shaft Bracket Screw for 7-32, 7-40, 7-42, 7-44, 7-45, 7-53 and 7-55 Machines.....
123E	901	Shuttle Race Clamping Screw for 7-29 Machine.....
123E	901	Shuttle Race Screw for 7-22, 7-26, 7-36, 7-37, 7-42, to 7-45, 7-50 to 7-52 and 7-54 Machines.....
128E	901	Vibrating Presser Bar Cap Bracket Screw (short) for 11911, 19555, 19755, 19960, 19962, 19963 and 58250.....
129E	901	Feed Reverse Lever Bracket Screw for 7-11 and 7-46 Machines.....
129E	901	Needle Bar Connecting Stud Clamping Screw for 19565 and 58242.....
129E	901	Spool Holder Bracket Screw for 7-10 and 7-47 Machines.....
134E	900	Arm Side Plate Screw for 11628, obsolete
134E	900	Driving Attachment Lever Screw for 58286, 58378, 58441, 58460, 58461 and 58464.....
134E	900	Feed Lifting Rock Shaft Wearing Block Screw for 19968, 19970, 58346 and 58390
134E	900	Feed (lower) Lifting Rock Shaft Wearing Block Screw for 19970, 58346 and 58390
134E	900	Feed (upper) Bar Guide Bracket (upper) Screw (front) for 7-43 and 7-54 Machines
134E	900	Feed Reverse Stop Lever Bracket Screw for 7-11 and 7-46 Machines.....
134E	900	Lifting Lever Bracket Screw for 19521....
134E	900	Oil Cup Screw.....
134E	900	Shuttle Race Ring Screw for 19778 and 58365.....

NO.	PLATE	NAME
134E	900	Shuttle Race Screw for 7-1 to 7-8, 7-10, 7-11, 7-13 to 7-18, 7-20, 7-24, 7-30, 7-32, 7-35, 7-40, 7-46, 7-47, 7-53 and 7-55 Machines.....
135E	899	Bed Bracket Screw for 11519 (Accessories)
135E	899	Bobbin Winder Screw for 11754.....
135E	899	Feed Lifting Rock Shaft Crank Clamping Screw for 19765, obsolete.....
135E	899	Knee Plate Clamping Screw for 11896, obsolete.....
138E	3583	Bobbin Winder Thread Unwinder Spool Rest Set Screw for 27556 and 41451....
138E	3583	Bobbin Winder Thread Unwinder Thread Guard Rod Set Screw for 27557.....
138E	898	Lifting Presser Bar Spring Bracket Screw for 11494, obsolete.....
138E	3583	Thread Unwinder Spool Rest Set Screw for 27556.....
138E	3583	Thread Unwinder Thread Guard Rod Set Screw for 27557 and 60636.....
138E	898	Treadle Extension Set Screw for 11843, obsolete.....
141E	901	Lifting Presser Bar Rock Shaft Eccentric Strap Adjusting Screw for 11486.....
145F	899	Cloth Plate Screw for 7-26, 7-37, 7-43, 7-50 to 7-52 and 7-54 Machines.....
145E	899	Feed Bar Guide Bracket (upper) Screw for 7-14, 7-20 and 7-35 Machines.....
145E	899	Feed Bar Hinge Bracket Adjusting Screw for 11048 and 11071.....
145E	899	Feed (upper) Bar Guide Bracket (upper) Screw for 7-30 Machine.....
145E	899	Feed (upper) Bar Hinge Bracket Adjusting Screw for 11071 and 19674.....
145E	899	Lifting Presser Bar Bracket Clamping Screw for 11478.....
145E	899	Lifting Presser Bar Bracket Clamping Screw (upper) for 19910.....
145E	899	Switch Clutch Lever Bracket Screw for 7-11 and 7-46 Machines.....
145E	899	Tension Bracket and Vibrating Presser Bar Cap Screw for 7-42, 7-44 and 7-45 Machines.....
145E	899	Tension Bracket and Vibrating Presser Bar Cap Screw (right) for 7-40, 7-53 and 7-55 Machines.....
145E	899	Vibrating Presser Bar Hinge Bracket Adjusting Screw for 11510 and 19920.....

NO.	PLATE	NAME
145E	899	Vibrating Presser Bar Cap Bracket Screw for 7-32 Machine.....
149F	874	Needle Clamp Screw for 9060.....
155c	3583	Bobbin Winder Pulley Set Screw for 41443
155E	901	Feed Cam Clutch Screw for 11590.....
158E	901	Thread Retaining Bracket Screw for 7-10, 7-24 and 7-47 Machines.....
159E	901	Feed (upper) Bar Guide Bracket (upper) Screw (back) for 7-43 and 7-54 Machines
159E	901	Lifting Presser Bar Bell Crank Lifting Cam Screw for 11550 and 11858.....
159E	901	Lifting Presser Bar Guide Bracket Adjusting Screw for 11463 and 58402.....
159E	901	Presser Bar Clutch Hinge Bracket Adjusting Screw for 11034 and 11062.....
159E	901	Presser Bar Guide Bracket Adjusting Screw for 11404.....
159E	901	Switch Clutch Driver Screw for 7-11 and 7-46 Machines.....
159F	901	Tension Bracket and Vibrating Presser Bar Cap Screw (left) for 7-40, 7-53 and 7-55 Machines.....
161E	901	Face Plate Screw for 7-10, 7-22, 7-24, 7-26, 7-36, 7-37, 7-47 and 7-50 to 7-52 Machines.....
161E	901	Feed Reverse Lever Stop Washer Screw for 7-11 and 7-46 Machines.....
161E	901	Switch Clutch Driving Screw for 11590...
164E	899	Arm Side Plate Screw for 11351, obsolete
164D	4415	Binder Screw for 11576.....
164E	899	Bobbin Winder Screw for 11752, obsolete
164E	899	Buff Wheel Clamp Carrier Stop Screw for 7-24 and 7-32 Machines.....
164E	899	Buff Wheel Clamp Carrier Weight Connection Pulley Bracket Screw for 7-24 and 7-32 Machines.....
164E	899	Face Plate Thread Guard Screw for 19885 and 58217.....
164D	4415	Guide Screw for 19658, for 7-10 and 7-47 Machines.....
164D	899	Lap Seam Feller Screw for 26789 and 26794
164E	899	Lifting Presser Bar Bell Crank Connecting Stud Cap Screw for 11527.....
164E	899	Lifting Presser Bar Lifter Cap Screw for 7-10 Machine, obsolete.....
164E	4406	Oscillating Shaft Crank Slide Block Cap Screw for 19773.....

NO.	PLATE	NAME
164E	899	Presser Bar Clutch Roller Cap Screw for 11055 and 19881.....
164E	899	Presser Bar Hinge Cap Screw for 7-11 and 7-46 Machines and obsolete for 7-16 to 7-18 Machines.....
164E	899	Shuttle Race Ring Screw for 11415 and 11933.....
164E	899	Tension Thread Guard Screw for 7-43 and 7-54 Machines.....
164E	899	Thread Take-up Spring Lever Regulator Screw for 7-43 and 7-54 Machines....
164E	899	Thread Take-up Spring Regulator Screw for 19596, 19865, 19885, 58215, 58217, 7-26 and 7-30 Machines.....
164E	899	Thread Take-up Spring Screw for 19596, 19865, 19885, 58215 and 58217.....
164E	899	Vibrating Presser Bar Hinge Cap Screw for 7-40, 7-53 and 7-55 Machines and obsolete for 7-5 to 7-8, 7-13 and 7-15 to 7-18 Machines.....
164E	899	Vibrating Presser Foot Screw for 7-10 and 7-47 Machines.....
166E	899	Buff Wheel Clamp Carrier Sliding Rack Cap Screw for 7-32 Machine.....
166E	899	Feed Dog Screw for 7-1 to 7-8, 7-10, 7-11, 7-13, 7-15 to 7-18, 7-29, 7-32, 7-46 and 7-47 Machines.....
166E	899	Feed (lower) Dog Screw for 7-30 Machine
166E	899	" Point Screw for 7-14, 7-20 and 7-35 Machines.....
166E	899	Lifting Presser Bar Bell Crank Hinge Cap Screw for 7-32, 7-40, 7-42, 7-45, 7-53 and 7-55 Machines.....
166E	899	Lifting Presser Bar Lifting Link Cap Screw for 7-40, 7-53 and 7-55 Machines.....
166E	899	Lifting Presser Foot Screw for 7-30 Machine.....
166E	899	Presser Foot Screw for 7-14, 7-20 and 7-35 Machines.....
166E	899	Thread Eyelet Screw for 7-22, 7-26, 7-36, 7-37 and 7-50 to 7-52 Machines.....
166E	899	Thread Eyelet (double) Screw for 7-42 to 7-45 and 7-54 Machines.....
168E	4494	Lifting Presser Foot Clamping Screw for 58276 and 58540.....
168E	4494	Thread Unwinder Spool Rest Set Screw for 27778.....

NO.	PLATE	NAME
172F	923	Needle Clamp Adjusting Screw for 19730, obsolete.....
175E	901	Oscillating Rock Shaft Oil Pad Screw for 11396, 11792, 11824 and 11860 to 11862, obsolete.....
176E	3583	Bobbin Winder Tripping Arm Clamping Screw for 41447 and 41899.....
178F	899	Bobbin Winder Stand Shaft Set Screw for 9062, obsolete.....
178F	899	Bobbin Winder Stop Latch Bracket Set Screw for 9070.....
180D	901	Shuttle Race Slide Screw for 7-40, 7-53 and 7-55 Machines.....
180D	901	Shuttle Race Slide (right) Screw for 7-1 to 7-8, 7-10, 7-14, 7-16 to 7-18, 7-20, 7-30, 7-35 and 7-47 Machines.....
180E	901	Thread Retaining Bracket Screw for 7-22, 7-26, 7-36, 7-37 and 7-50 to 7-52 Machines.....
190E	899	Buff Wheel Clamp Carrier Sliding Rack Cap Roller Cap Screw for 1885.....
190E	899	Corder Cord Guide Screw for 26799.....
190E	899	Face Plate Thread Guard Screw for 19596, 19865 and 58215.....
190E	899	Feed Bar Guide Bracket (lower) Cap Screw for 11717 and 19726.....
190E	899	Feed (upper) Bar Guide Bracket (lower) Cap Screw for 19671, 19726 and 58349..
190E	899	Feed Lifting Rock Shaft Crank Roller Cap Screw for 1885.....
190E	899	Needle Bar Thread Eyelet Screw for 7-10 Machine, obsolete.....
190E	899	Oil Cup Lamp Holder Screw for 7-10 and 7-47 Machines.....
190E	899	Oscillating Shaft Crank Roller Cap Screw, obsolete.....
190E	899	Oscillating Shaft Crank Slide Block Cap Screw for 5868.....
190E	899	Presser Bar Clutch Hinge Bracket Stop Screw for 7-14, 7-20 and 7-35 Machines
190E	899	Presser Bar Guide Bracket Cap Screw for 11635.....
190E	899	Tension Bracket Screw for 7-1 to 7-8, 7-11, 7-13, 7-15 to 7-18, 7-29 and 7-46 Machines.....

NO.	PLATE	NAME
190E	899	Thread Eyelet (side of arm) Screw for 7-32, 7-40, 7-42, 7-44, 7-45, 7-53 and 7-55 Machines.....
190E	899	Thread Take-up Spring Regulator Plate Screw for 7-42, 7-44 and 7-45 Machines
190E	899	Thread Take-up Spring Regulator Plate Adjusting Screw for 11501 and for 7-1 to 7-8, 7-11, 7-13 to 7-18, 7-20, 7-29, 7-32, 7-35 and 7-46 Machines.....
190E	899	Vibrating Presser Bar Guide Bracket Cap Screw for 11469, 11724, 14594 and 19752
190E	899	Vibrating Presser Bar Spring Adjusting Staple Screw for 7-40, 7-53 and 7-55 Machines.....
190E	899	Vibrating Presser Bar Spring Stud Screw for 7-10, 7-22, 7-24, 7-26, 7-36, 7-37, 7-47 and 7-50 to 7-52 Machines.....
191F	899	Needle Set Screw for 19733, 19734, 58355 and 58356.....
191F	907	Roller Arm Lock Spring Screw for 19652..
191F	899	Vibrating Presser Foot Screw for 7-13 and 7-15 Machines, obsolete.....
193F	901	Feed Bar Hinge Pin Set Screw for 11071
193F	901	" (upper) Bar Hinge Pin Set Screw for 11071.....
193F	901	Tension Bracket Screw for 7-14, 7-20, 7-30 and 7-35 Machines.....
194E	4451	Buff Wheel Clamp Carrier Driving Gear Disengaging Lever Stop Screw for 58396 to 58398 and 58536 to 58538.....
202F	900	Throat Plate Needle Hole Strip Screw for 11556.....
202E	900	Vibrating Presser Bar Spring Stop Screw for 7-32 Machine.....
207F	4415	Binder Bed Spring Guide Screw for 11576
207F	901	Needle Set Screw for 19566, obsolete.....
207F	901	Oil Cup Cover Latch Spring Screw for 11920, 11921, 19534 and 58254.....
207F	901	Oil or Wax Stripper Washer Screw for 11920, 11921, 19534 and 58254.....
207E	901	Thread Take-up Spring Bracket Screw for 7-42, 7-44 and 7-45 Machines.....
207E	901	Vibrating Presser Bar Spring Stop Screw for 7-42, 7-44 and 7-45 Machines.....
208E	4451	Vibrating Presser Bar Spring Screw for 7-32, 7-42, 7-44 and 7-45 Machines.....

NO.	PLATE	NAME
211F	901	Lifting Presser Foot Set Screw for 19914 and 19951.....
212c	903	Vibrating Presser and Stretching Foot Stop Screw for 7-24 Machine, obsolete.....
219F	901	Throat Plate Needle Plate Screw for 11433, 11737, 11888, 19807, 19875, 58241, 58292, 58433 and 58543.....
223F	899	Shuttle Cylinder Latch Spring Screw for 11794, obsolete.....
223E	899	Vibrating Presser Bar Spring Screw for 7-40, 7-53 and 7-55 Machines.....
231c	901	Feed Regulator Adjusting Screw Stop Screw for 19528.....
231c	901	Feed (upper) Regulator Adjusting Screw Stop Screw for 19528.....
231c	901	Vibrating Presser Bar Spring Bracket Screw for 14594.....
233E	901	Feed Reverse Stop Lever Cushion Screw for 7-11 and 7-46 Machines.....
233E	901	Vibrating Presser Bar Cushion Screw for 7-40, 7-53 and 7-55 Machines.....
252E	898	Pressure Regulating Thumb Screw for 7-1 to 7-8, 7-11, 7-13, 7-15 to 7-18, 7-29 and 7-46 Machines.....
254D	902	Guide Thumb Screw for 19656, 19725 and for 7-1 to 7-8, 7-10, 7-11, 7-13 to 7-18, 7-20, 7-30, 7-35, 7-42 and 7-44 to 7-47 Machines.....
257E	902	Lifting Presser Bar Screw Bushing (lower) for 7-30, 7-43 and 7-54 Machines.....
257E	902	Needle Bar Screw Bushing (upper) for 7-42, 7-44, 7-45 and 7-50 to 7-52 Machines.....
257E	902	Needle Bar Screw Bushing for 7-22, 7-26, 7-30, 7-36, 7-37, 7-43, 7-50 to 7-52 and 7-54 Machines.....
257E	902	Presser Bar Screw Bushing for 7-14, 7-20 and 7-35 Machines.....
258E	899	Lifting Presser Bar Screw Bushing for 7-5 to 7-8, 7-11, 7-13, 7-15 to 7-18, 7-32, 7-40, 7-42, 7-44 to 7-46, 7-53 and 7-55 Machines.....
258E	899	Needle Bar Screw Bushing for 7-1 to 7-8, 7-10, 7-11, 7-13, to 7-18, 7-20, 7-24, 7-29, 7-32, 7-35, 7-40, 7-46, 7-47, 7-53 and 7-55 Machines.....

NO.	PLATE	NAME
258E	899	Presser Bar Screw Bushing for 7-1 to 7-4 and 7-29 Machines.....
283D	902	Guide Slide Clamping Plate Thumb Screw for 19656 and 19725.....
283D	902	Guide Thumb Screw for 7-10 Machine, obsolete.....
284D	899	Bobbin Winder Frame Thumb Screw for 11752, obsolete.....
294c	4453	Feed Lifting Rock Shaft Screw Center for 58594.....
294c	4453	Feed (lower) Lifting Rock Shaft Screw Center (right) for 58594.....
294c	4453	Feed Rock Shaft Screw Center for 58594
294c	4453	" (lower) Rock Shaft Screw Center (right) for 58594.....
304c	898	Feed Lifting Rock Shaft Screw Center, obsolete.....
304c	898	Oscillating Rock Shaft Screw Center, obsolete.....
307c	898	Feed Bar Screw Center for 56814.....
307c	898	" (lower) Bar Screw Center for 56814
308c	898	" Bar Screw Center, obsolete.....
315F	907	Roller Arm Screw Center for 19652.....
330E	3583	Bobbin Winder Thread Unwinder Thread Guard Set Screw for 60609.....
330D	3583	Shuttle (inside) Cylinder Latch Spring Screw for 43250.....
330D	3583	Shuttle (outside) Cylinder Latch Spring Screw for 43249.....
330E	3583	Thread Unwinder Thread Guard Set Screw for 60609 and 60611.....
333E	4453	Arm Spool Bracket Screw for 7-22 Machine, obsolete.....
346E	4453	Feed Lifting Rock Shaft Crank Clamping Screw for 19812, 19814, 19816 and 19819
346E	4453	Feed (lower) Lifting Rock Shaft Crank Clamping Screw for 19812 and 19819...
346E	4453	Feed Rock Shaft Crank Clamping Screw for 58235.....
346E	4453	Feed (lower) Rock Shaft Crank Clamping Screw for 58235.....
347c	900	Balance Wheel Set Screw for 11517.....
353c	899	Lifting Presser Bar Spring Bracket Set Screw for 11465.....
353c	899	Presser Bar Lifting Link Cap Screw for 11404.....

NO.	PLATE	NAME
354c	899	Balance Wheel and Pulley (tight) Set Screw for 58407.....
354c	899	Balance Wheel Set Screw for 11356, 11358, 11438, 11678, 19991, 58247, 58249, 58335, 58411 and 122301.....
354c	899	Belt Shifter Pulley (tight) Set Screw for 11456, obsolete.....
354c	899	Driving Attachment Balance Wheel Set Screw for 58335 and 122301.....
354c	899	Driving Attachment Treadle Pitman Rod Clamp Screw for 9079.....
362f	899	Driving Attachment Treadle Stop Collar Set Screw for 2762, obsolete.....
362f	899	Presser Foot Screw for 11412, 11686 and 19708.....
362f	907	Roller Arm Bracket Set Screw for 19651..
372c	898	Crank Connecting Rod Hinge Screw, obsolete.....
372c	898	Feed Connecting Link Hinge Screw, obsolete.....
372c	898	Feed Forked Connection Hinge Screw, obsolete.....
372c	898	Feed Lifting Rock Shaft Crank Roller Screw for 1866.....
372c	898	Lifting Presser Bar Bell Crank Adjusting Link Roller Screw for 1828.....
372c	898	Presser Bar Lifting Bell Crank Adjusting Link Roller Screw for 1828.....
373f	907	Roller Screw for 1929.....
375c	4451	Needle Bar Connecting Link Hinge Screw, obsolete.....
381E	899	Buff Wheel Clamp Carrier Locking Rack Screw for 7-24 and 7-32 Machines.....
381E	899	Feed Bar Hinge Bracket Guide Plate Screw for 7-14, 7-20 and 7-35 Machines
381E	899	Feed (upper) Bar Hinge Bracket Guide Plate Screw for 7-30, 7-43 and 7-54 Machines.....
381E	899	Feed Dog Screw for 7-22, 7-26, 7-36, 7-37, 7-40, 7-42, 7-44, 7-45, 7-50 to 7-53 and 7-55 Machines.....
381E	899	Feed (lower) Dog Screw for 7-43 and 7-54 Machines.....
381E	899	Lifting Presser Bar Guide Bracket Guide Screw for 7-5 to 7-8, 7-11, 7-13, 7-15 to 7-18 and 7-46 Machines.....

NO.	PLATE	NAME
381E	899	Lifting Presser Bar Spring Bracket Screw for 11032, obsolete.....
381D	899	Needle Plate Screw for 7-14, 7-20, 7-30 and 7-35 Machines.....
381E	899	Presser Bar Guide Bracket Guide Screw, for 7-1 to 7-4 and 7-29 Machines.....
381E	899	Presser Bar Spring Bracket Screw for 11032, obsolete.....
381E	899	Spool Holder Bracket Screw for 7-10 Machine, obsolete.....
381D	899	Throat Plate Screw for all machines except 7-50 to 7-52 and 7-54.....
389F	901	Cloth Plate Screw for 7-11, 7-13, 7-15, 7-22, 7-24, 7-32, 7-36, 7-42 and 7-44 to 7-46 Machines.....
389D	901	Throat Plate Needle Hole Strip Screw for 19711 and 58386.....
399E	4401	Presser Bar Rack Screw for 19879.....
401E	899	Balance Wheel Friction Washer Screw for 58289, 58290, 58336 and 122302.....
401D	899	Buff Wheel Clamp Carrier Spindle Plate Screw for 19943 and 58530.....
401D	899	Buff Wheel Clamp Spindle Plate Screw for 9169.....
401E	899	Driving Attachment Balance Wheel Friction Washer Screw for 58336 and 122302
401D	899	Guide Screw for 120690, for 7-11 and 7-46 Machines.....
401D	899	Throat Plate Needle Hole Strip Screw for 11638, 11688, 11948, 19516, 19593, 19643, 19740, 19743, 19745, 19917, 58369 and 58371.....
401D	899	Throat Plate Needle Plate Screw (small) for 58375 and 58377.....
408E	898	Thread Retaining Screw Stud for 58600..
411E	898	Tension Screw Stud for 58589.....
423F	907	Roller Arm Adjusting Screw for 19652....
434c	899	Belt Shifter Fork Set Screw for 11449 and 11941.....
434c	899	Feed Bar Hinge Bracket Set Screw (short) for 11071.....
434c	899	Feed (upper) Bar Hinge Bracket Set Screw (short) for 11048 and 11071.....
434c	899	Thread Take-up Cam Set Screw for 11428, 11505, 11549, 11550, 11630, 11805, 11815, 11817, 11857 and 19513.....

NO.	PLATE	NAME
435c	900	Belt Shifter Pulley (loose) Flanged Bushing Set Screw for 58409.....
435c	900	Lifting Presser Bar Spring Adjusting Block Set Screw for 11537, obsolete.....
437c	899	Arm Shaft Bushing Set Screw.....
445c	900	Feed Bar Hinge Bracket Set Screw (short) for 11048, obsolete.....
445c	900	Feed (upper) Bar Hinge Bracket Set Screw (short) for 19674.....
445c	900	Feed Cam Set Screw for 11367, 11694, 19526 and 58511.....
445c	900	Feed (lower) Cam Set Screw for 11367....
445c	900	" (upper) Cam Set Screw for 19676 and 58511.....
445c	900	Feed Rock Shaft Crank Set Screw for 11601, obsolete.....
445c	900	Lifting Presser Bar Bell Crank Connecting Stud Set Screw (small) for 19682....
445f	900	Needle Bar Connecting Stud Set Screw for 11383, 19565 and 19902.....
445c	900	Oscillating Shaft Crank Set Screw for 19770
445c	900	Shuttle Driver Set Screw for 11932, 19572, 19774 and 58361.....
446c	899	Needle Bar Connecting Stud Set Screw for 7-10 Machine, obsolete.....
446c	899	Presser Bar Guide Bracket Set Screw for 11634.....
448c	900	Belt Shifter Pulley (loose) Collar Set Screw for 11459.....
448c	900	Belt Shifter Slide Rod Collar Set Screw for 11453 and 11459.....
448c	900	Belt Shifter Slide Rod Spring Collar Set Screw for 11453.....
448c	900	Bobbin Winder Friction Pulley Set Screw for 43270.....
448c	900	Driving Attachment Friction Pulley Set Screw for 11440.....
448c	900	Feed Bar Hinge Bracket Support Screw for 7-14, 7-20 and 7-35 Machines.....
448c	900	Feed (upper) Bar Hinge Bracket Support Screw for 7-30, 7-43 and 7-54 Machines
448c	900	Table Belt Guide Pulley Shaft Set Screw for 58263.....
448c	900	Vibrating Presser Bar Guide Bracket Set Screw for 11468 and 14593.....
449c	3583	Bobbin Winder Spindle Collar Set Screw for 41553.....

NO.	PLATE	NAME
449c	3583	Bobbin Winder Frame Hinge Pin Set Screw for 41894.....
453c	899	Buff Wheel Clamp Carrier Locking Rack Bracket Hinge Pin Set Screw for 19602
453c	899	Buff Wheel Clamp Carrier Locking Rack Bracket Latch Body Set Screw for 19605
453c	899	Buff Wheel Clamp Carrier Sliding Flange Set Screw for 19609.....
453c	899	Feed Bar Guide Bracket (lower) Set Screw for 11716, obsolete.....
453c	899	Feed Lifting Rock Shaft Crank Set Screw for 11374, 11783 and 11785, obsolete....
453c	899	Feed Regulator Set Screw for 11697 and 19528.....
453c	899	Feed (upper) Regulator Set Screw for 19528
453c	899	" Regulator Shaft Collar Set Screw for 11393.....
453c	899	Feed (upper) Regulator Shaft Collar Set Screw for 11393.....
453c	899	Feed Regulator Shaft Crank Set Screw for 11700, obsolete.....
453c	899	Feed Regulator Shaft Driving Crank Set Screw for 11708.....
453c	899	Feed (upper) Regulator Shaft Driving Crank Set Screw for 11708.....
453c	899	Feed Rock Shaft Crank Set Screw for 11379, obsolete.....
453c	899	Feed Shaft Crank Set Screw for 11706 and 19531.....
453c	899	Feed (upper) Shaft Crank Set Screw for 19531 and 19678.....
453c	899	Feed Shaft Driving Crank Set Screw for 19532.....
453c	899	Feed (upper) Shaft Driving Crank Set Screw for 19532.....
453c	899	Lifting Collar Set Screw for 19517.....
453c	899	" Presser Bar Guide Bracket Set Screw for 11463 and 58402.....
453c	899	Lifting Presser Bar Guide Set Screw for 58270.....
453c	899	Lifting Presser Bar Rock Shaft Adjusting Arm Set Screw for 58578.....
453c	899	Lifting Presser Bar Rock Shaft Crank Set Screw for 11484.....
453c	899	Lifting Presser Bar Spring Collar Set Screw for 11411.....

NO.	PLATE	NAME
453c	899	Oscillating Shaft Collar Set Screw for 11393.....
453c	899	Oscillating Shaft Crank Set Screw for 11395, 11788, 11790, 19696 and 19697..
453c	899	Presser Bar Guide Bracket Set Screw for 11404.....
453c	899	Presser Bar Spring Collar Set Screw for 11411.....
453c	899	Shuttle Driver Set Screw for 11727, 11800 and 11856.....
454c	4494	Bobbin Winder Spindle Set Screw for 60215
456c	9620	Feed Bar Guide Bracket (lower) Set Screw for 19546.....
456c	9620	Feed (upper) Bar Guide Bracket (lower) Set Screw for 19546, 19670 and 58348
458c	3583	Bobbin Winder Frame Hinge Pin Set Screw for 41439 and 41550.....
460c	4451	Vibrating Presser Bar Hinge Pin Set Screw for 58402.....
462c	4451	Buff Wheel Clamp Carrier Sliding Flange Gear Set Screw for 19611.....
462c	4451	Buff Wheel Clamp Carrier Spindle Gear Set Screw for 19944.....
462c	4451	Buff Wheel Clamp Spindle Gear Set Screw for 19611.....
470E	893	Bobbin Winder Tension Spool Pin, fixed cone, for 9071, obsolete.....
496E	4453	Arm Screw for 7-26 and 7-37 Machines, obsolete.....
497E	900	Driving Attachment Lever Bracket Bolt with 1522E, for 58286, 58378, 58441, 58460, 58461 and 58464.....
507E	898	Bed Bracket Bolt with 1515E (Accessories)
523c	901	Lifting Presser Bar Bell Crank Connecting Stud Set Screw (large) for 19682.....
523c	901	Lifting Presser Bar Spring Adjusting Block Set Screw for 11869, obsolete.....
524c	9619	Lifting Presser Bar Lifting Link Cap Screw for 7-5 to 7-8, 7-11, 7-13, 7-15 to 7-18 and 7-46 Machines.....
528E	859	Bobbin Winder Clamping Screw for 11766
564c	898	Feed Lifting Rock Shaft Screw Center for 58384.....
564c	898	Feed (lower) Lifting Rock Shaft Screw Center for 58384.....
564c	898	Feed Rock Shaft Screw Center for 58384....

NO.	PLATE	NAME
564c	898	Feed (lower) Rock Shaft Screw Center for 58384.....
564c	898	Oscillating Rock Shaft Screw Center, obsolete.....
565c	898	Crank Connecting Rod Hinge Screw for 7-1 to 7-8, 7-10, 7-11, 7-13 to 7-18, 7-20, 7-22, 7-24, 7-29, 7-30, 7-32, 7-35, 7-36, 7-40, 7-42, 7-44 to 7-47, 7-53 and 7-55 Machines.....
565c	898	Feed Connecting Link Hinge Screw for 7-1 to 7-8, 7-10, 7-11, 7-13, 7-15 to 7-18, 7-22, 7-24, 7-26, 7-29, 7-32, 7-36, 7-37, 7-40, 7-42, 7-44 to 7-47 and 7-50 to 7-53 and 7-55 Machines.....
565c	898	Feed (lower) Connecting Link Hinge Screw for 7-30, 7-43 and 7-54 Machines.....
565c	898	Feed Forked Connection Hinge Screw for 7-1 to 7-8, 7-10, 7-11, 7-13, 7-15 to 7-18, 7-22, 7-24, 7-26, 7-29, 7-32, 7-36, 7-37, 7-40, 7-42, 7-44 to 7-47, 7-50 to 7-53 and 7-55 Machines.....
565c	898	Feed (lower) Forked Connection Hinge Screw for 7-30, 7-43 and 7-54 Machines
566c	898	Needle Bar Connecting Link Hinge Screw
567D	898	Belt Shifter Chain Pulley Screw for 11445 and 11945.....
567D	898	Feed Reverse Stop Lever Hinge Screw for 7-11 and 7-46 Machines.....
567D	898	Thread Take-up Lever Hinge Screw, obsolete.....
568c	898	Feed Dog Carrier Hinge Screw for 7-24 and 7-32 Machines.....
568E	898	Feed Regulator Hinge Screw for 7-1 to 7-8, 7-10, 7-11, 7-13, 7-15 to 7-18, 7-22, 7-24, 7-26, 7-29, 7-32, 7-36, 7-37, 7-40, 7-42, 7-44 to 7-47, 7-50 to 7-53 and 7-55 Machines.....
568E	898	Feed (lower) Regulator Hinge Screw for 7-30, 7-43 and 7-54 Machines.....
590D	901	Shuttle Cylinder Latch Spring Screw for 58294.....
590D	901	Shuttle (inside) Cylinder Latch Spring Screw for 58514.....
590D	901	Shuttle (outside) Cylinder Latch Spring Screw for 58514.....
597c	900	Driving Attachment Shaft Driving Pulley Clamping Screw for 9091 and 11864....

NO. PLATE	NAME
605c 4453	Oscillating Rock Shaft Screw Center, obsolete.....
606E 902	Thread Retaining Screw Stud for 58597..
607E 902	Tension Screw Stud, for 58598.....
608E 900	Lifting Presser Bar Rock Shaft Eccentric Strap Hinge Screw for 7-32, 7-40, 7-42, 7-44, 7-45, 7-53 and 7-55 Machines.....
609D 902	Lifting Presser Bar Spring Regulating Thumb Screw for 7-10, 7-22, 7-26, 7-30, 7-32, 7-36, 7-37 and 7-40 Machines, obsolete.....
609D 902	Presser Bar Spring Regulating Thumb Screw for 7-14, 7-20 and 7-35 Machines, obsolete.....
610E 901	Lifting Presser Bar Bell Crank Lifting Roller Screw for 1851.....
611c 905	Lifting Presser Bar Bell Crank Adjusting Link Screw for 19681 and 19809, for 7-10, 7-16, 7-22, 7-24, 7-26, 7-30, 7-36, 7-37, 7-43, 7-47 and 7-50 to 7-52 Machines.....
611c 905	Presser Bar Lifting Bell Crank Adjusting Link Screw for 7-14, 7-20 and 7-35 Machines.....
612E 901	Vibrating Presser Bar Cap Bracket Screw (long) for 11911, 19555, 19755, 19960, 19962, 19963 and 58250.....
618c 4453	Oscillating Rock Shaft Screw Center, obsolete.....
622c 899	Oscillating Rock Shaft Hinge Pin Screw Bearing for 11397 and 11842, obsolete..
632E 862	Tension Screw Stud for 58596.....
633E 862	Thread Retaining Screw Stud for 58592..
647E 4451	Lifting Presser Bar Bracket Clamping Screw (lower) for 19910.....
654c 4453	Oscillating Rock Shaft Hinge Pin Screw Bearing for 19790, obsolete.....
657E 903	Buff Wheel Clamp Carrier Sliding Rack Stop Screw for 7-32 Machine.....
657c 903	Vibrating Presser and Stretching Foot Hinge Screw for 7-24 and 7-32 Machines
664J 901	Shuttle Race Cap Latch Spring Screw for 19551.....
670E 862	Shuttle Race Frame Clamping Screw for 7-1 to 7-8, 7-10, 7-11, 7-13 to 7-18, 7-20, 7-24, 7-30, 7-32, 7-35, 7-40, 7-46, 7-47, 7-53 and 7-55 Machines.....

NO. PLATE	NAME
680F 862	Needle Clamp Thumb Screw for 11542 and 19702.....
681D 862	Vibrating Presser Bar Hinge Screw for 7-10, 7-22, 7-24, 7-26, 7-36, 7-37, 7-47 and 7-50 to 7-52 Machines.....
682D 862	Vibrating Presser Bar Stop Block Thumb Screw for 7-10, 7-22, 7-26, 7-27, 7-36, 7-47 and 7-50 to 7-52 Machines.....
682D 862	Vibrating Presser Bar Stop Thumb Screw for 11565, obsolete.....
685E 905	Buff Wheel Clamp Carrier Sliding Rack Screw for 7-24 Machine, obsolete.....
686E 902	Thread Retaining Screw Stud for 58590..
690E 4451	Feeding Foot Screw for 7-43 and 7-54 Machines.....
690E 4451	Thread Take-up Spring Staple Screw for 7-14, 7-20, 7-30 and 7-35 Machines.....
690E 4451	Tension Thread Guard Screw for 7-42, 7-44 and 7-45 Machines.....
690E 4451	Vibrating Presser Foot Screw for 7-22, 7-26, 7-36, 7-37, 7-42, 7-44, 7-45 and 7-50 to 7-52 Machines.....
691F 905	Buff Wheel Clamp Carrier Cap Screw for 58396 to 58398, 58536 to 58538 and for 7-24, 7-32, 7-40, 7-53 and 7-55 Machines
691F 905	Buff Wheel Clamp Carrier Stop Plate Screw for 7-24, 7-32, 7-40, 7-53 and 7-55 Machines.....
691F 905	Guide Plate Screw for 7-24 and 7-32 Machines.....
691D 905	Throat Plate Needle Hole Strip Screw for 58425, 58429.....
691D 905	Throat Plate Needle Plate Screw (large) for 58375 and 58377.....
704E 9620	Presser Foot Screw for 7-11 and 7-46 Machines.....
709E 4451	Tension Screw Stud for 58593.....
710E 4451	" " " " 58599.....
742D 9620	Throat Plate Needle Hole Strip Screw for 58438, 58440, 58457 and 58584.....
761c 900	Feed Cam Position Screw for 11590.....
773F 7268	Shuttle Tension Regulating Screw for 11794, 19986, 58213 and 58404.....
774F 4494	Shuttle (inside) Tension Regulating Screw for 58513.....
774F 4494	Shuttle (outside) Tension Regulating Screw for 58518.....

NO.	PLATE	NAME
792c	903	Buff Wheel Clamp Carrier Sliding Rack Stop Screw for 7-24 Machine, obsolete..
795c	9620	Feed (upper) Bar Hinge Bracket Set Screw (long) for 19674.....
828c	4494	Bobbin Winder Thread Unwinder Tension Screw Stud for 60609.....
828c	4494	Thread Unwinder Tension Screw Stud for 60609 and 60611.....
830f	901	Needle Clamp Spring Screw for 11543, obsolete.....
832c	9620	Feed Bar Hinge Bracket Set Screw (long) for 11071.....
832c	9620	Feed (upper) Bar Hinge Bracket Set Screw (long) for 11071.....
850E	902	Tension Screw Stud for 58591.....
851E	857	Spool Holder Tension Spool Pin with fixed cone, for 11881.....
858c	900	Lifting Presser Bar Bell Crank Connecting Stud Set Screw for 11526.....
869E	901	Feed Forked Connection Friction Spring Screw for 7-11 and 7-46 Machines.....
874E	4491	Vibrating Presser Bar Stop Block Stop Screw for 58239.....
885D	902	Guide Thumb Screw for 7-22, 7-26, 7-29, 7-36, 7-37, 7-43, 7-50 to 7-52 and 7-54 Machines.....
894E	899	Bobbin Winder Base Screw for 60219, 60260, 60272, 60273, 60275 and 60277 to 60279.....
894D	899	Cloth Plate Screw for 7-29 Machine.....
896E	4491	Lifting Presser Bar Guide Adjusting Screw for 58270.....
898E	901	Needle Clamp Screw for 19735 and 58354
898E	901	Vibrating Presser Foot Screw for 7-5 to 7-8, 7-13, 7-15 to 7-18, 7-40, 7-53 and 7-55 Machines.....
909c	9620	Balance Wheel Set Screw for 58563.....
910c	900	Lifting Presser Bar Lifter Hinge Pin Set Screw for 19596, 19865, 19885, 58215 and 58217.....
912c	903	Feed Regulator Adjusting Screw for 7-14, 7-20 and 7-35 Machines.....
912c	903	Feed (upper) Regulator Adjusting Screw for 7-30, 7-43 and 7-54 Machines.....
913E	903	Lifting Presser Bar Screw Bushing (upper) for 7-30, 7-43 and 7-54 Machines.....

NO.	PLATE	NAME
913D	903	Pressure Regulating Thumb Screw for 7-14 and 7-20 Machines, obsolete.....
915E	903	Thread Retaining Screw Stud for 7-22 Machine, obsolete.....
917D	900	Buff Wheel Clamp Carrier Weight Connection Pulley Screw for 7-24 and 7-32 Machines.....
918D	900	Buff Wheel Screw for 7-24 Machine, obsolete.....
919c	900	Feed Dog Screw for 7-24 Machine, obsolete.....
949E	4494	Arm Shaft Screw for 7-3, 7-7, 7-11, 7-13, 7-14, 7-15, 7-17, 7-20, 7-24, 7-29, 7-30, 7-35, 7-36, 7-37, 7-43, 7-44, 7-46, 7-47 and 7-54 Machines.....
965E	4451	Buff Wheel Clamp Carrier Rack Screw for 7-40, 7-53 and 7-55 Machines.....
1015c	4453	Feed Lifting Rock Shaft Screw Center (front) for 58601.....
1015c	4453	Feed (lower) Lifting Rock Shaft Screw Center (left) for 58601.....
1015c	4453	Feed (lower) Rock Shaft Screw Center (left) for 58601.....
1036c	9620	Driving Attachment Brake Block Stud Set Screw for 58459 and 58463.....
1044D	4451	Corder Cord Guide Arm Hinge Screw for 26799.....
1054c	4421	Buff Wheel Clamp Carrier Sliding Rack Cap Roller Screw Stud for 1885.....
1054c	4421	Feed Lifting Rock Shaft Crank Roller Screw Stud for 1885.....
1054c	4421	Oscillating Shaft Crank Roller Screw Stud, obsolete.....
1054c	4421	Oscillating Shaft Crank Slide Block Screw Stud for 5868.....
1140F	923	Needle Clamp Thumb Screw for 19730, obsolete.....
1149c	9620	Lifting Collar Set Screw for 64052.....
1151c	4452	Crank Connecting Rod Hinge Screw for 7-26, 7-37, 7-43, 7-50 to 7-52 and 7-54 Machines.....
1156c	4406	Oscillating Shaft Crank Slide Block Screw Stud for 19773.....
1161E	9620	Buff Wheel Clamp Carrier Spindle Screw Stud Thumb Nut Spring Screw for 58533.....

NO.	PLATE	NAME
1177E	4494	Lifting Presser Bar Spring Bracket Screw for 7-10, 7-22, 7-26, 7-30, 7-32, 7-36, 7-37, 7-40, 7-42 to 7-45, 7-47 and 7-50 to 7-55 Machines.....
1177E	4494	Presser Bar Spring Bracket Screw for 7-14, 7-20 and 7-35 Machines.....
1192c	9620	Feed Bar Guide Bracket (lower) Position Screw for 19546.....
1192c	9620	Feed (upper) Bar Guide Bracket (lower) Position Screw for 19546.....
1192c	9620	Presser Bar Guide Bracket Position Screw for 11634.....
1192c	9620	Vibrating Presser Bar Guide Bracket Position Screw for 14593.....
1323F	901	Shuttle (inside) Tension Regulating Screw for 43286 and 58405.....
1323F	901	Shuttle (outside) Tension Regulating Screw for 43287 and 58403.....
1323F	901	Shuttle Tension Regulating Screw for 43288.....
1326F	4451	Pressure Regulating Thumb Screw for 7-14, 7-20 and 7-35 Machines.....
1402E	4494	Balance Wheel Ball Washer (right) Screw for 58336 and 122302.....
1402E	4494	Driving Attachment Balance Wheel Ball Ring Washer (right) Screw for 58336 and 122302.....
1480D	4448	Buff Wheel Clamp Carrier Driving Gear Disengaging Lever Shaft Cap Screw for 58396 to 58398 and 58536 to 58538....
1497F	4491	Lifting Presser Bar Lifter Bracket Set Screw for 58237.....
1497F	4491	Vibrating Presser Bar Guide Bracket Set Screw for 58239.....
1503J	903	Feed Lifting Rock Shaft Screw Center Nut for 58594.....
1503J	903	Feed Lifting Rock Shaft Screw Center (front) Nut for 58601.....
1503J	903	Feed (lower) Lifting Rock Shaft Screw Center (left) Nut for 58601.....
1503J	903	Feed (lower) Lifting Rock Shaft Screw Center (right) Nut for 58594.....
1503J	903	Feed Rock Shaft Screw Center Nut for 58594.....
1503J	903	Feed (lower) Rock Shaft Screw Center (left) Nut for 58601.....

NO.	PLATE	NAME
1503J	903	Feed (lower) Rock Shaft Screw Center (right) Nut for 58594.....
1503J	903	Oscillating Rock Shaft Hinge Pin Nut for 19790 and 58595.....
1503J	903	Oscillating Rock Shaft Hinge Pin Screw Bearing Nut for 19790 and 58551.....
1508J	890	Feed Lifting Rock Shaft Screw Center Nut for 58384.....
1508J	890	Feed (lower) Lifting Rock Shaft Screw Center Nut for 58384.....
1508J	890	Feed Rock Shaft Screw Center Nut for 58384.....
1508J	890	Feed (lower) Rock Shaft Screw Center Nut for 58384.....
1508J	890	Oscillating Rock Shaft Hinge Pin Nut for 58293 and 58586.....
1508J	890	Oscillating Rock Shaft Hinge Pin Screw Bearing Nut for 11397, 11842, 58566 and 58572.....
1508J	890	Oscillating Rock Shaft Screw Center Nut for 564 and 605, obsolete.....
1508J	890	Oscillating Shaft Crank Slide Block Screw Stud Nut for 19789.....
1513J	890	Buff Wheel Clamp Carrier Sliding Rack Cap Roller Screw Stud Nut for 7-32 Machine.....
1513J	890	Crank Connecting Rod Hinge Screw Nut for 7-1 to 7-8, 7-10, 7-11, 7-13 to 7-18, 7-20, 7-22, 7-24, 7-29, 7-30, 7-32, 7-36, 7-37, 7-40, 7-42, 7-44 to 7-47, 7-53 and 7-55 Machines.....
1513J	890	Feed Bar Screw Center Nut for 56814....
1513J	890	" (lower) Bar Screw Center Nut for 56814.....
1513J	890	Feed Connecting Link Hinge Screw Nut for 7-1 to 7-8, 7-10, 7-11, 7-13, 7-15 to 7-18, 7-20, 7-22, 7-24, 7-26, 7-29, 7-32, 7-36, 7-37, 7-40, 7-42, 7-44 to 7-47, 7-50 to 7-53 and 7-55 Machines...
1513J	890	Feed (lower) Connecting Link Hinge Screw Nut for 7-30, 7-43 and 7-54 Machines..
1513J	890	Feed Forked Connection Hinge Screw Nut for 7-1 to 7-8, 7-10, 7-11, 7-13, 7-15 to 7-18, 7-22, 7-24, 7-26, 7-29, 7-32, 7-36, 7-37, 7-40, 7-42, 7-44 to 7-47, 7-50 to 7-53 and 7-55 Machines.....

NO.	PLATE	NAME
1513J	890	Feed (lower) Forked Connection Hinge Screw Nut for 7-30, 7-43 and 7-54 Machines.....
1513J	890	Feed Lifting Rock Shaft Crank Roller Screw Stud Nut for 19816.....
1513J	890	Feed Lifting Rock Shaft Screw Center, Nut, obsolete.....
1513J	890	Needle Bar Connecting Link Hinge Screw Nut.....
1513J	890	Oscillating Shaft Crank Roller Screw Stud Nut, obsolete.....
1513J	890	Oscillating Rock Shaft Screw Center Nut for 304 and 618, obsolete.....
1513J	890	Oscillating Shaft Crank Slide Block Screw Stud Nut for 19696 and 19697.....
1515E	890	Bed Bracket Bolt Nut for 507.....
1517J	890	Feed Bar Screw Center Nut, obsolete.....
1518J	907	Crank Connecting Rod Hinge Screw Nut, obsolete.....
1518J	907	Feed Connecting Link Hinge Screw Nut, obsolete.....
1518J	907	Feed Forked Connection Hinge Screw Nut, obsolete.....
1518J	907	Feed Lifting Rock Shaft Crank Roller Screw Nut for 19814.....
1518J	907	Feed Regulator Shaft Crank Roller and Screw Stud Nut for 11701, obsolete.....
1518J	907	Feed Reverse Stop Lever Roller and Screw Stud Nut for 11846.....
1518J	907	Feed Shaft Crank Roller and Screw Stud Nut for 19531.....
1518J	907	Feed (upper) Shaft Crank Roller and Screw Stud Nut for 19531 and 19678.....
1518J	907	Lifting Presser Bar Bell Crank Adjusting Link Roller Screw Nut for 11525, 19540 and 19810.....
1518J	907	Lifting Presser Bar Bell Crank Lifting Roller Screw Nut for 7-32, 7-40, 7-42, 7-44, 7-45, 7-53 and 7-55 Machines....
1518J	907	Lifting Presser Bar Rock Shaft Eccentric Strap Hinge Screw Nut for 7-32, 7-40, 7-42, 7-44, 7-45, 7-53 and 7-55 Machines
1518J	907	Needle Bar Connecting Link Hinge Screw Nut, obsolete.....
1518J	907	Presser Bar Lifting Bell Crank Adjusting Link Roller Screw Nut for 19540.....
1518J	907	Roller Arm Screw Center Nut for 19652..
1518J	907	" Screw Nut for 1929.....

NO.	PLATE	NAME
1518J	907	Thread Take-up Lever Roller and Screw Stud Nut for 1951, 1990, 1995 and 11430
1520J	905	Driving Attachment Lever Spring Hook Nut for 19664, 19862, 58379, 58380, 58443 and 58508 to 58510.....
1520J	905	Feed Bar Hinge Bracket Support Screw Nut for 7-14, 7-20 and 7-35 Machines..
1520J	905	Feed (upper) Bar Hinge Bracket Support Screw Nut for 7-30, 7-43 and 7-54 Machines.....
1520J	905	Feed Forked Connection Friction Spring Screw Nut for 7-11 and 7-46 Machines.
1520F	907	Roller Arm Adjusting Screw Nut for 19652
1522E	903	Driving Attachment Lever Bracket Bolt Nut for 497.....
1528C	903	Lifting Presser Bar Rock Shaft Eccentric Strap Adjusting Screw Nut for 11486..
1535E	903	Tension Regulating Thumb Nut for 58593 and 58599.....
1541E	890	Bobbin Winder Tension Regulating Thumb Nut for 9071, obsolete.....
1541E	890	Spool Holder Tension Spool Pin Nut for 11881.....
1547J	903	Vibrating Presser Foot Screw Nut for 7-5 to 7-8, 7-13, 7-15 to 7-18, 7-40, 7-53 and 7-55 Machines.....
1549E	903	Presser Bar Clutch Hinge Bracket Stop Screw Nut for 7-14, 7-20 and 7-35 Machines.....
1560C	3583	Bobbin Winder Thread Unwinder Tension Regulating Thumb Nut for 60609.....
1560C	903	Tension Regulating Thumb Nut for 58589, 58591, 58596 and 58598.....
1560C	903	Thread Retaining Regulating Thumb Nut for 58590, 58592, 58597 and 58600.....
1560C	3583	Thread Unwinder Tension Regulating Thumb Nut for 60609 and 60611.....
1596D	903	Feed Regulator Adjusting Screw Nut for 7-14, 7-20 and 7-35 Machines.....
1596D	903	Feed (upper) Regulator Adjusting Screw Nut for 7-30, 7-43 and 7-54 Machines...
1620E	903	Vibrating Presser and Stretching Foot Hinge Screw Nut for 7-24 and 7-32 Machines.....
1646J	903	Crank Connecting Rod Hinge Screw Nut for 7-26, 7-37, 7-43, 7-50 to 7-52 and 7-54 Machines.....

NO.	PLATE	NAME
1654c	903	Feeding Foot Screw Nut for 7-43 and 7-54 Machines.....
1654c	903	Vibrating Presser Foot Screw Nut for 7-22, 7-26, 7-36, 7-37, 7-42, 7-44, 7-45 and 7-50 to 7-52 Machines.....
1700j	9620	Presser Foot Screw Nut for 7-11 and 7-46 Machines.....
1804	899	Buff Wheel Clamp Carrier Sliding Rack Roller and Stud for 9161.....
1804	899	Feed Lifting Rock Shaft Crank Roller and Stud for 11783, obsolete.....
1804	899	Feed Regulator Shaft Driving Crank Roller and Stud for 11708.....
1804	899	Feed (upper) Regulator Shaft Driving Crank Roller and Stud for 11708.....
1804	899	Oscillating Shaft Crank Roller and Stud for 11788, obsolete.....
1813	899	Switch Clutch Lever Roller and Stud for 11610.....
1813	899	Thread Take-up Lever Roller and Screw Stud for 11803, obsolete.....
1828	899	Lifting Presser Bar Bell Crank Adjusting Link Roller with 372c, for 11525, 19540 and 19810.....
1828	899	Presser Bar Lifting Bell Crank Adjusting Link Roller with 372c, for 19540.....
1844	4452	Feed Lifting Rock Shaft Crank Roller and Stud for 11785, obsolete.....
1844	4452	Oscillating Shaft Crank Roller and Stud for 11790, obsolete.....
1845	899	Feed Regulator Shaft Crank Roller and Screw Stud for 11701, obsolete.....
1845	899	Feed Shaft Crank Roller and Screw Stud for 19531.....
1845	899	Feed (upper) Shaft Crank Roller and Screw Stud for 19531 and 19678.....
1845	899	Thread Take-up Lever Roller and Screw Stud for 11430.....
1850	900	Lifting Presser Bar Rock Shaft Crank Roller and Stud for 11484.....
1851	900	Lifting Presser Bar Bell Crank Lifting Roller with 610E, for 7-32, 7-40, 7-42, 7-44, 7-45, 7-53 and 7-55 Machines.....
1861	862	Feed Lifting Rock Shaft Crank Roller and Stud for 11374, 19765, 19812 and 19819.....

NO.	PLATE	NAME
1861	862	Feed (lower) Lifting Rock Shaft Crank Roller and Stud for 19812 and 19819..
1861	862	Oscillating Shaft Crank Roller and Stud for 11395, obsolete.....
1866	900	Feed Lifting Rock Shaft Crank Roller with 372c, for 19814.....
1885	900	Buff Wheel Clamp Carrier Sliding Rack Cap Roller with 190E, 1054c and 5968, for 7-32 Machine.....
1885	900	Feed Lifting Rock Shaft Crank Roller with 190E, 1054c and 5968, for 19816..
1892	900	Feed Reverse Stop Lever Roller and Screw Stud for 11846.....
1916	4401	Presser Bar Clutch Roller for 11055 and 19881.....
1929	907	Roller, 1¼ in. diam., with 373F and 1518J, for 19652.....
1948	4452	Thread Take-up Lever Thread Guiding Roller and Screw Stud for 19754, 19868, 58298 and 58300.....
1951	4452	Thread Take-up Lever Roller and Screw Stud with 1518J, for 11845, obsolete...
1990	4452	Thread Take-up Lever Roller and Screw Stud with Cap Screw and 1518J, for 11845, obsolete.....
1995	4452	Thread Take-up Lever Roller and Screw Stud with 1518J, for 11845, 19589, 19754, 19780, 19868, 58296, 58298, 58300, 58302, 58304 and 58306.....
2002	853	Lifting Presser Bar Rock Shaft Bracket Dowel Pin (lower) for 7-32, 7-40, 7-42, 7-44, 7-45, 7-53 and 7-55 Machines.....
2022	887	Buff Wheel Clamp Carrier Locking Rack Bracket Hinge Pin Dowel Pin for 7-24 and 7-32 Machines.....
2022	887	Buff Wheel Clamp Carrier Locking Rack Bracket Latch Body Pin for 7-24 and 7-32 Machines.....
2022	887	Feed Lifting Rock Shaft Wearing Block Position Pin for 19968, 19970, 58346 and 58390.....
2022	887	Feed (lower) Lifting Rock Shaft Wearing Block Position Pin for 19970, 58346 and 58390.....
2022	887	Lifting Presser Bar Bell Crank Lifting Cam Pin for 11858.....

224 NUMERICAL LIST OF PARTS

NO.	PLATE	NAME
2027	—	Shuttle Cylinder Latch Pin for 19636, obsolete.....
2049	853	Buff Wheel Clamp Carrier Driving Gear Plate Flanged Bushing Pin for 58396 to 58398 and 58536 to 58538.....
2049	853	Buff Wheel Clamp Carrier Sliding Flange Pin for 7-24 and 7-32 Machines.....
2049	853	Buff Wheel Clamp Carrier Sliding Flange Gear Pin for 7-24 and 7-32 Machines..
2049	853	Buff Wheel Clamp Carrier Driving Gear Disengaging Lever Pin for 19939.....
2049	853	Buff Wheel Clamp Carrier Spindle Gear Pin for 58396 to 58398 and 58536 to 58538.....
2049	853	Buff Wheel Clamp Spindle Gear Pin for 7-24 and 7-32 Machines.....
2049	853	Feed Bar Hinge Washer Pin for 7-14 and 7-20 Machines, obsolete.....
2049	853	Lifting Collar Pin for 19512, 19521 and 19879.....
2049	853	Lifting Presser Foot Pin for 7-32, 7-40, 7-53 and 7-55 Machines.....
2049	853	Thread Retaining Thread Guide Pin for 11546.....
2049	853	Vibrating Presser Bar Guide Bracket Pin for 11561, for 7-24 Machine, obsolete..
2102	3583	Bobbin Winder Thread Unwinder Tension Disc for 60609.....
2102	888	Thread Retaining Disc for 11041, 11426, 11503, 11546 and 19587.....
2102	3583	Thread Unwinder Tension Disc for 60609
2103	3583	Bobbin Winder Thread Unwinder Tension Spring for 60609.....
2103	888	Thread Retaining Spring for 11041, 11426, 11503, 11546 and 19587.....
2103	3583	Thread Unwinder Tension Spring for 60609 and 60611.....
2117	890	Belt Shifter Guide Rod Pin for 11445 and 11945.....
2117	890	Belt Shifter Slide Rod Pin for 11445, 11945 and 19994.....
2117	890	Feed Lifting Rock Shaft Crank Pin, obsolete.....
2117	890	Feed Rock Shaft Crank Pin, obsolete.....
2117	890	" (upper) Bar Guide Bracket (lower) Pin for 7-43 and 7-54 Machines.....
2117	890	Feed Shaft Crank Pin for 7-14, 7-20 and 7-35 Machines.....

NUMERICAL LIST OF PARTS 225

NO.	PLATE	NAME
2117	890	Feed (upper) Shaft Crank Pin for 7-30, 7-43 and 7-54 Machines.....
2117	890	Feed Shaft Driving Crank Pin for 7-14, 7-20 and 7-35 Machines.....
2117	890	Feed (upper) Shaft Driving Crank Pin for 7-30, 7-43 and 7-54 Machines.....
2117	890	Lifting Lever Bracket Dowel Pin for 19521.....
2117	890	Lifting Presser Bar Bell Crank Lifting Cam Pin for 11550, obsolete.....
2117	890	Lifting Presser Bar Lifter Bracket Pin for 11531, obsolete.....
2117	890	Lifting Presser Bar Rock Shaft Adjusting Arm Pin for 7-32, 7-40, 7-42, 7-44, 7-45, 7-53 and 7-55 Machines.....
2117	890	Lifting Presser Bar Rock Shaft Crank Pin for 7-32, 7-40, 7-42, 7-44, 7-45, 7-53 and 7-55 Machines.....
2117	890	Presser Bar Guide Bracket Pin, obsolete.
2117	890	Oscillating Shaft Crank Pin for 7-1 to 7-8, 7-10, 7-11, 7-13 to 7-18, 7-20, 7-22, 7-24, 7-29, 7-30, 7-32, 7-35, 7-36 and 7-40 Machines, obsolete.....
2117	890	Shuttle Driver Pin for 7-1 to 7-8, 7-10, 7-11, 7-13 to 7-18, 7-20, 7-24, 7-30, 7-32, 7-35, 7-40, 7-46, 7-47, 7-50, 7-53 and 7-55 Machines.....
2117	890	Vibrating Presser Bar Guide Bracket Pin for 14593, for 7-5 and 7-16 Machines, obsolete.....
2205	887	Oil Cup Cover Latch Spring for 11920, 11921 and 58254.....
2269	889	Bobbin Winder Pulley Driving Wheel Stud Pin for 11754 and 11766.....
2269	3583	Bobbin Winder Stop Latch Pin for 41555, 60217 and 60630.....
2269	889	Needle Clamp Pin for 19731 and 7-22 Machine, obsolete.....
2448	891	Bobbin Winder Spindle Pulley for 9061, obsolete.....
2460	897	Bobbin Winder Friction Ring (rubber) for 11748 and 11752, obsolete.....
2461	891	Bobbin Winder Spindle Pulley for 11748 and 11752, obsolete.....

NO.	PLATE	NAME
2718r	897	Driving Attachment Treadle Extension Screw Washer for 126037.....
2718	897	Lifting Presser Bar Bell Crank Adjusting Link Roller Screw Nut Washer for 11525, 19540 and 19810.....
2718	897	Lifting Presser Bar Bell Crank Lifting Roller Screw Nut Washer for 7-32, 7-40, 7-42, 7-44, 7-45, 7-53 and 7-55 Machines
2718	897	Presser Bar Lifting Bell Crank Adjusting Link Roller Screw Nut Washer for 19540
2762	4454	Driving Attachment Treadle Stop Collar with 362r, for 27640, obsolete.....
2875	896	Driving Attachment Treadle, obsolete....
3012	853	Belt Shifter Guide Rod Pin for 19994....
3012	853	Feed Regulator Pin for 7-14, 7-20 and 7-35 Machines.....
3012	853	Feed (upper) Regulator Pin for 7-30, 7-43 and 7-54 Machines.....
3012	853	Feed Regulator Shaft Driving Crank Pin for 7-14, 7-20 and 7-35 Machines.....
3012	853	Feed (upper) Regulator Shaft Driving Crank Pin for 7-30, 7-43 and 7-54 Machines.....
3012	853	Vibrating Presser Bar Guide Bracket Pin for 7-13 and 7-15 Machines, obsolete....
3146	4415	Binder Bed Spring Guide Screw Washer for 11576.....
3146	4415	Feed Reverse Lever Handle Washer for 19505.....
4389	853	Lifting Presser Bar Rock Shaft Bracket Dowel Pin (upper) for 7-32, 7-40, 7-42, 7-44, 7-45, 7-53 and 7-55 Machines....
4784	3583	Bobbin Winder Frame Oil Pad for 41555, 41558, 41900 and 60217.....
4879	858	Belt Shifter Chain Connecting Link for 4885.....
4879	858	Chain Connecting Link for 4885..... Nos. 4881 to 4884 for 4885
4881	609	Belt Shifter Treadle.....
4881	609	Treadle.....

NO.	PLATE	NAME
4882	858	Belt Shifter Treadle Shaft.....
4882	858	Treadle Shaft.....
4883	858	Belt Shifter Treadle Spring.....
4883	858	Treadle Spring.....
4884	609	Belt Shifter Treadle Stand.....
4884	609	Treadle Stand.....
4885	609	Belt Shifter Treadle complete for 11945 and 19994, Nos. 4879, 4881 to 4884 and two wood screws 1 in. No. 16.....
4885	609	Treadle complete for 19521 and 19648, Nos. 4879, 4881 to 4884 and two wood screws 1 in. No. 16.....
5667	609	Foot Lever for 5668, obsolete.....
5668	609	" " 5667 with 5669, 5671 and three wood screws 1½ in. No. 16, for 11445, obsolete.....
5669	609	Foot Lever Bracket for 5668, obsolete....
5671	897	" " Hinge Pin for 5668, obsolete..
5672	9617	" " Lifting Spring for 11445, obsolete.....
5769	3583	Bobbin Winder Thread Unwinder Tension Thread Eyelet for 60609.....
5769	3583	Thread Unwinder Tension Thread Eyelet for 60609 and 60611.....
5868	4421	Oscillating Shaft Crank Slide Block complete for 19696 and 19697, Nos. 190e, 1054c, 5968 and 9119.....
5968	887	Buff Wheel Clamp Carrier Sliding Rack Cap Roller Cap Screw Washer for 1885
5968	887	Feed Lifting Rock Shaft Crank Roller Cap Screw Washer for 1885.....
5968	887	Oscillating Shaft Crank Roller Cap Screw Washer, obsolete.....
5968	887	Oscillating Shaft Crank Slide Block Cap Screw Washer for 5868.....
5983	4492	Tension Friction Washer (felt) for 12042..
6037	889	Corder Cord Guide Bracket Rivet for 26796.....
6055	4454	Driving Attachment Lever Spring Hook Nut Washer for 19664, 19862, 58379, 58380, 58443 and 58508 to 59510.....
6055	4454	Driving Attachment Treadle Pitman Rod (lower) Spring Washer for 27640, obsolete.....
6312	862	Thread Retaining Screw Stud Washer for 19587.....

NO.	PLATE	NAME
6312	862	Vibrating Presser Bar Stop Block Thumb Screw Washer for 7-10, 7-22, 7-26, 7-36, 7-37, 7-47 and 7-50 to 7-52 Machines..
6312	862	Vibrating Presser Bar Stop Block Washer (large) for 11565, obsolete.....
6439	—	Belt Shifter Chain, 36 in. to 45 in., with 56864 and 56865, for 11445, 11945 and 19994.....
7071	4415	Binder Bed Spring Guide Cam Stud Washer for 11576.....
7585	4442	Buff Wheel Clamp Carrier Sliding Flange Shaft for 7-32 Machine.....
7958	890	Bobbin Winder Spindle Frame Spring Pin for 9070, obsolete.....
7958	890	Presser Bar Lifter Link Hinge Stud Pin for 11407, obsolete.....
8018	890	Bobbin Winder Tension Spool Pin Adjustable Cone for 9071, obsolete.....
8018	887	Spool Holder Tension Spool Pin Cone for 11881.....
8019	887	Bobbin Winder Tension Spool Pin Adjustable Cone Spring for 9071, obsolete
8019	887	Spool Holder Tension Spool Pin Spring for 11881.....
8055	860	Lifting Lever Hinge Pin for 19521 and 19648.....
8055	860	Shuttle Driver Pin for 7-26, 7-37, 7-43, 7-50 to 7-52 and 7-54 Machines.....
8077	879	Feed Bar Spring Hook for 11720, obsolete
8077	879	" Dog Carrier Spring Hook for 19632.
8077	879	Thread Take-up Spring Hook for 19904..
8380	893	Bobbin Winder Pulley Driving Wheel Handle (wood) for 11761.....
8382	887	Bobbin Winder Pulley Driving Wheel Handle Stud Washer for 11761.....
8482	890	Oil or Wax Stripper Washer (steel) for 58253, for 11920, 11921, 19534 and 58254.....
8582	889	Presser Foot Hinge Pin for 19708.....
8702	887	Arm Dowel Pin for 7-1 to 7-8, 7-10, 7-11, 7-13 to 7-18, 7-20, 7-22, 7-24, 7-29, 7-30, 7-32, 7-35, 7-36, 7-40, 7-42, 7-44 to 7-47, 7-53 and 7-55 Machines.....
8708	827	Arm Spool Pin for 7-1 to 7-8, 7-11, 7-13 to 7-18, 7-20, 7-24, 7-29, 7-30, 7-32, 7-35, 7-40, 7-46, 7-53 and 7-55 Machines

NO.	PLATE	NAME
8734	886	Buff Wheel Clamp Carrier Sliding Rack Spring for 7-24 and 7-32 Machines.....
8734	886	Feed Dog Carrier Spring for 7-24 Machine, obsolete.....
8734	886	Vibrating Presser Bar Spring for 7-13 and 7-15 Machines.....
8749	874	Needle Clamp Gib for 9060.....
8760	888	Lifting Presser Bar Lifter Friction Washer for 7-5 to 7-8, 7-11, 7-13, 7-15 to 7-18, 7-30, 7-32, 7-40 to 7-46 and 7-53 to 7-55 Machines.....
8760	888	Presser Bar Lifter Friction Washer for 7-1 to 7-4, 7-14, 7-20, 7-29 and 7-35 Machines.....
8761	890	Lifting Presser Bar Lifter Stop Pin for 11909.....
8761	890	Presser Bar Lifter Stop Pin for 11407, 11829 and 11909.....
8763	890	Lifting Presser Bar Lifting Link Hinge Stud for 11909.....
8763	890	Presser Bar Lifting Link Hinge Stud for 11407, 11829 and 11909.....
8773	907	Roller Arm Lock Spring for 19652.....
8777	9621	Shuttle Cylinder Hinge Pin for 43285.....
8777	9621	" (inside) Cylinder Hinge Pin for 43275 and 58358.....
8777	9621	Shuttle (outside) Cylinder Hinge Pin for 43283 and 58360.....
8778	9621	Shuttle (outside) Cylinder Latch Spring for 43249.....
8779	883	Shuttle (outside) Frame for 43249.....
8780	883	" " Tension Spring for 58403
8787	890	Tension Regulating Thumb Nut Washer for 19701 and 19889.....
8791	888	Tension Spring for 11042, 11871, 12042 and 58317.....
8804	892	Belt Shifter Frame Handle for 11449 and 11941.....
8873	887	Balance Wheel Pin for 19664 and 19862, obsolete.....
8873	887	Bed Extension Dowel Pin for 7-24, 7-32, 7-40, 7-53 and 7-55 Machines.....
8873	887	Feed Rock Shaft Crank Pin for 7-11, 7-13, 7-15 and 7-46 Machines.....
8873	887	Oscillating Shaft Crank Pin for 7-26, 7-37, 7-43, 7-50 to 7-52 and 7-54 Machines...

NO.	PLATE	NAME
8873	887	Shuttle Driver Pin for 7-22, 7-29 and 7-36 Machines.....
8873	887	Thread Take-up Cam Pin.....
8879	887	Tension Friction Washer (cloth) for 11042, 11420, 11871 and 58317.....
8879	887	Tension Friction Washer (cloth) small, for 19701 and 19889.....
8893	6029	Shuttle (inside) Cylinder Latch Spring for 43250.....
8894	9609	Shuttle (inside) Frame for 43250.....
8895	9622	" " Tension Spring for 43286 and 58405.....
8900	9622	Shuttle (outside) Tension Spring for 43287
8905	887	Tension Regulating Thumb Nut Washer for 11042, 11420, 11871, 12042 and 58317.....
8905	887	Thread Retaining Regulating Thumb Nut Washer for 11041, 11426, 11503, 11546 and 19587.....
8908	4484	Wrench for 1520 and 1620 (Accessories) ..
8909	4484	" " 353, 523, 609, 1513, 1517, 50323 and 51581 (Accessories).....
8910	4484	Wrench for 338, 611, 1508 and 1596 (Accessories).....
8911	4484	Wrench for 1503 (Accessories).....
8937	862	Balance Wheel Pin for 11356, obsolete....
8951	862	Oil Cup Thread Eyelet, obsolete.....
8953	874	" or Wax Stripper (felt) for 11920, 11921, 19534 and 58254.....
8961	833	Shuttle (inside) Cylinder Hinge Pin for 58516.....
8961	833	Shuttle (outside) Cylinder Hinge Pin for 58521.....
8961	833	Shuttle Cylinder Hinge Pin for 11794 and 19636.....
8964	833	Shuttle Tension Spring for 19986
8973	862	Lifting Presser Bar Lifting Link Hinge Stud Pin for 7-5 to 7-8, 7-11, 7-13, 7-15 to 7-18, 7-30, 7-32, 7-40, 7-42 to 7-46 and 7-53 to 7-55 Machines.....
8973	862	Presser Bar Lifting Link Hinge Stud Pin for 7-1 to 7-4, 7-14, 7-20, 7-29 and 7-35 Machines.....
8984	827	Driving Attachment Brake Block (wood) for 58286, 58378, 58441, 58460, 58461 and 58464.....

NO.	PLATE	NAME
8991	828	Driving Attachment Lever Screw Washer for 58286, 58378, 58441, 58460, 58461 and 58464.....
8992	828	Driving Attachment Lever Spring for 58286, 58378, 58441, 58460, 58461 and 58464.....
9042	890	Feed Bar Guide Bracket (lower) Cap Hook for 11718, obsolete.....
9042	890	Vibrating Presser Bar Guide Bracket Cap Hook for 11725 and 19751.....
9042	890	Vibrating Presser Bar Spring Bracket Hook for 11739.....
9043	9621	Feed Bar Hinge Washer, for 7-14 and 7-20 Machines, obsolete.....
9046	879	Thread Take-up Spring Lever Stop Pin for 19906, obsolete.....
9060	874	Needle Clamp with 149F and 8749, for 7-30 Machine.....
9061	891	Bobbin Winder (automatic) complete for 11910, Nos. 24D, 2448, 9062 to 9071, 9074 and two wood screws 1 in. No. 7, obsolete.....
Nos. 9062 TO 9071 FOR 9061, OBSOLETE		
9062	891	Bobbin Winder Stand with 178F.....
9063	891	" " " Shaft.....
9064	890	" " " Collar.....
9065	891	" " " Pulley.....
9066	891	" " Spindle.....
9067	891	" " Frame.....
9068	890	" " " Spring....
9069	891	" " Stop Latch.....
9070	891	" " " Bracket with 178F and 7958.....
9071	891	Bobbin Winder Tension Spool Pin complete, Nos. 470E, 1541E, 8018 and 8019
9074	893	Bobbin Winder Tension Thread Guide Pin for 9061.....
9079	9629	Driving Attachment Treadle Pitman Rod Clamp with 354c, for 27640 and 60626
9084	889	Oil Cup Cover Hinge Pin for 11920, 11921, 19534 and 58254.....
9091	4480	Driving Attachment Shaft Driving Pulley (sectional) 10 in. diam., 1½ in. face, 1⅞ in. bore, with two 597c, for 58379, 58380, 58443 and 58508 to 58510.....

NO.	PLATE	NAME
9115	4433	Oscillating Rock Shaft Hinge Pin for 19790, obsolete.....
9119	4421	Oscillating Shaft Crank Slide Block for 5868.....
9137	—	Belt Shifter Chain Pulley for 19994.....
Nos. 9159 TO 9165 FOR 7-32 MACHINE		
9159	4442	Buff Wheel Clamp Carrier with 19614....
9160	4442	" " " " Cap.....
9161	4442	" " " " Locking Rack with 9164 and two 1804.....
9162	4442	Buff Wheel Clamp Carrier Sliding Rack with 9164.....
9163	4442	Buff Wheel Clamp Carrier Sliding Rack Cap.....
9164	889	Buff Wheel Clamp Carrier Sliding Rack Spring Hook for 9161 and 9162.....
9165	4443	Buff Wheel Clamp Carrier Stop.....
9167	4442	" " " " Weight Connection Pulley for 7-32 Machine.....
9168	4443	Buff Wheel Clamp Spindle for 9169.....
9169	—	" " " " 9168 with 9170 and three 401b, for 7-32 Machine.....
9170	4443	Buff Wheel Clamp Carrier Spindle Plate with three 9199, for 19943.....
9170	4443	Buff Wheel Clamp Spindle Plate with three 9199, for 9169.....
9173	4444	Feed Dog, 5 teeth (8 teeth to the inch) for 19917, for 7-32 Machine.....
9199	879	Buff Wheel Clamp Carrier Spindle Plate Spur for 9170 and 58531.....
9199	879	Buff Wheel Clamp Spindle Plate Spur for 9170.....
9219	9621	Thread Take-up Lever Thread Eyelet Bushing for 58303.....
9521	4448	Buff Wheel Clamp Carrier Driving Gear Disengaging Lever Shaft Cap Screw Washer for 58396 to 58398 and 58536 to 58538.....
9525	889	Thread Take-up Spring Staple Washer for 11501.....
9842	4492	Arm Shaft Screw Washer for 7-3, 7-7, 7-11, 7-13, 7-14, 7-15, 7-17, 7-20, 7-24, 7-29, 7-30, 7-35, 7-36, 7-37, 7-43, 7-44, 7-46, 7-47 and 7-54 Machines.....
9842	4492	Bobbin Winder Bracket Screw Washer for 60219, 60260, 60272, 60273, 60275 and 60277 to 60279.....

NO.	PLATE	NAME
10106	889	Needle Clamp Disc for 11543, obsolete...
10107	889	" " Spring for 11543, obsolete
11014	884	Feed Point for 7-14, 7-20 and 7-35 Machines.....
11031	863	Lifting Presser Bar Spring (flat) for 7-10, 7-22, 7-26, 7-30, 7-36, 7-37, 7-43, 7-47 and 7-50 to 7-52 Machines.....
11031	863	Presser Bar Spring (flat) for 7-14, 7-20 and 7-35 Machines.....
11032	846	Lifter Presser Bar Spring Bracket for 7-22, 7-26, 7-29, 7-30, 7-36 and 7-37 Machines, obsolete.....
11032	846	Presser Bar Spring Bracket for 7-14, 7-20 and 7-35 Machines, obsolete.....
11033	885	Presser Bar Spring (spiral) for 7-14, 7-20 and 7-35 Machines.....
11034	846	Presser Bar Clutch Hinge Bracket with 159E, for 7-14 and 7-20 Machines, obsolete.....
11036	—	Presser Bar Clutch for 11055, obsolete...
11040	9621	Shuttle Race Cap Latch Spring for 19551
11041	—	Thread Retainer complete for 7-1 to 7-8, 7-11, 7-13 to 7-18, 7-20, 7-29, 7-30, 7-35 and 7-46 Machines, Nos. 2103, 8905, 58590 and two 2102.....
11041	—	Thread Retainer (short stud) complete for 7-42 to 7-45 and 7-54 Machines, Nos. 2103, 8905, 58590 and two 2102..
11042	—	Tension (wheel) complete, for 7-30 Machine, Nos. 8701, 8905, 11043, 11044, 58596 and two 8879.....
11043	897	Tension Friction Washer (steel) for 11042 and 11871.....
11044	897	Tension Wheel for 11042, 11420, 11871, 12042 and 58317.....
11048	845	Feed Bar Hinge Bracket with 145E, 434c and 445c, for 7-14 and 7-20 Machines, obsolete.....
11052	887	Thread Take-up Spring for 7-1 to 7-8, 7-11, 7-13 to 7-18, 7-20, 7-29, 7-32, 7-35 and 7-46 Machines.....
11055	849	Presser Bar Clutch complete for 7-14 and 7-20 Machines, Nos. 164E, 1916, 11036 and 41544, obsolete.....
11062	922	Presser Bar Clutch Hinge Bracket with 159E, for 7-14, 7-20 and 7-35 Machines

NO.	PLATE	NAME
11071	878	Feed Bar Hinge Bracket with 145E, 193F, 434c and 832c, for 7-14, 7-20 and 7-35 Machines.....
11071	878	Feed (upper) Bar Hinge Bracket with 145E, 193F, 434c and 832c, for 7-30 Machine.....
11072	889	Feed Bar Hinge Pin for 7-14, 7-20 and 7-35 Machines.....
11072	889	Feed (upper) Bar Hinge Pin for 7-30 Machine.....
11075	921	Feed Point Packing for 7-14, 7-20 and 7-35 Machines.....
11075	921	Lifting Presser Foot Packing for 7-30 Machine.....
11075	921	Presser Foot Packing for 7-14, 7-20 and 7-35 Machines.....
11107	3580	Bobbin Winder Stop Latch Hinge Pin for 41555 and 60217.....
11165	897	Oscillating Rock Shaft Oil Pad for 11842, 19790, 58551, 58566 and 58572.....
11241	858	Arm Spool Pin Washer (cloth) for 7-1 to 7-8, 7-11, 7-13 to 7-18, 7-20, 7-24, 7-29, 7-30, 7-32, 7-35, 7-40, 7-43, 7-46, 7-53 and 7-55 Machines.....
11241	858	Tension Friction Washer (cloth) large, for 19889 and 19701.....
*11351	—	Arm with 11352, 15404 and two each 164e and 15405, for 7-1 to 7-8, 7-13 and 7-15 to 7-18 Machines, obsolete.....
*11352	—	Arm Side Plate for 11351, obsolete.....
11353	825	" Shaft for 7-1, 7-5, 7-6, 7-16, 7-35 and 7-42 Machines.....
11354	830	Arm Shaft Bushing.....
11356	896	Balance Wheel with two 354c, for 7-2, 7-4, 7-6, 7-8, 7-14, 7-16, 7-18, 7-22, 7-32, 7-35, 7-40 and 7-45 Machines, obsolete
11358	896	Balance Wheel (two speed) with two 354c, for 7-1, 7-5, 7-16, 7-35, 7-46 and 7-52 Machines.....
*11359	—	Bed for 7-1 to 7-8, 7-10, 7-11, 7-13 to 7-18, 7-30, 7-35, 7-46 and 7-47 Machines.....
11360	894	Bed Bracket (right) with wood screws 1 in. No. 16 (Accessories).....
11361	894	Bed Bracket (left) with wood screw 1 in. No. 16 (Accessories).....

NO.	PLATE	NAME
11363	825	Crank Connecting Rod for 7-1 to 7-8, 7-10, 7-11, 7-13 to 7-18, 7-20, 7-22, 7-24, 7-29, 7-30, 7-32, 7-35, 7-36, 7-40, 7-42, 7-44 to 7-47, 7-53 and 7-55 Machines...
11365	828	Feed Bar for 7-1 to 7-8, 7-10, 7-16 to 7-18, 7-29 and 7-47 Machines.....
11365	828	Feed (lower) Bar for 7-30 Machine.....
11367	830	" Cam with two 445c, for 7-1 to 7-8, 7-10, 7-13, 7-15 to 7-18, 7-22, 7-24, 7-26, 7-29, 7-32, 7-36, 7-37, 7-40, 7-42, 7-44, 7-45, 7-47, 7-50 to 7-52, 7-53 and 7-55 Machines.....
11367	830	Feed (lower) Cam with two 445c, for 7-30, 7-43, 7-54 and 7-55 Machines.....
11368	830	Feed Connecting Link for 7-1 to 7-8, 7-10, 7-11, 7-13, 7-15 to 7-18, 7-22, 7-24, 7-26, 7-29, 7-32, 7-36, 7-37, 7-40, 7-42, 7-44 to 7-47, 7-50 to 7-53 and 7-55 Machines
11368	830	Feed (lower) Connecting Link for 7-30, 7-43 and 7-54 Machines.....
11369	4416	Feed Dog, 14 teeth (10 teeth to the inch) for 11433, 58241, for 7-1 to 7-8, 26793, 28997 and 36181, and obsolete for 7-10 Machine.....
11370	825	Feed Forked Connection for 7-1 to 7-8, 7-10, 7-16 to 7-18, 7-22, 7-24, 7-29, 7-32, 7-40, 7-42, 7-44, 7-45, 7-47, 7-53 and 7-55 Machines.....
11370	825	Feed (lower) Forked Connection for 7-30 Machine.....
11374	830	Feed Lifting Rock Shaft Crank with 453c and 1861, for 11822, obsolete.....
11375	830	Feed Regulator for 7-1 to 7-8, 7-10, 7-11, 7-13, 7-15 to 7-18, 7-22, 7-24, 7-26, 7-29, 7-32, 7-36, 7-37, 7-40, 7-42, 7-44 to 7-47, 7-50 to 7-52, 7-53 and 7-55 Machines...
11375	830	Feed (lower) Regulator for 7-30, 7-43 and 7-54 Machines.....
11379	893	Feed Rock Shaft Crank with 453c, for 11820, obsolete.....
11380	828	Needle Bar for 7-1 to 7-8, 7-11, 7-14, 7-20, 7-24, 7-35, 7-40, 7-46, 7-53 and 7-55 Machines.....
11383	887	Needle Bar Connecting Stud with two 445F, for 19981.....
*11385	890	Needle Clamp Gib for 11542 and 19702..
11387	855	Oil Cup for 11920, obsolete.....

NO.	PLATE	NAME
11391	855	Oscillating Shaft, obsolete.....
11393	887	Feed Regulator Shaft Collar with two 453c, for 7-14, 7-20 and 7-35 Machines
11393	887	Feed (upper) Regulator Shaft Collar with two 453c, for 7-30, 7-43 and 7-54 Machines.....
11393	887	Oscillating Shaft Collar with two 453c, for 7-1 to 7-8, 7-10, 7-11, 7-13 to 7-18, 7-20, 7-24, 7-29, 7-30, 7-32, 7-35, 7-40, 7-46, 7-47, 7-53 and 7-55 Machines.....
11395	837	Oscillating Shaft Crank with 453c and 1861, obsolete.....
11396	831	Oscillating Rock Shaft with 175e, 11399 and two each 11400 and 11401, for 11397, obsolete.....
11397	—	Oscillating Rock Shaft complete, Nos. 622c, 1508j, 11396 and 58293, obsolete
11398	827	Oscillating Rock Shaft Hinge Pin for 58293, obsolete.....
11399	923	Oscillating Rock Shaft Oil Pad for 11396, 11792, 11824 and 11860 to 11862, obsolete.....
11400	837	Oscillating Rock Shaft Steel Plate for 11396 and 11824, obsolete.....
11401	837	Oscillating Rock Shaft Steel Plate Rivet for 11396, 11792, 11824 and 11860 to 11862, obsolete.....
11402	828	Lifting Presser Bar for 19512, for 7-5 to 7-8, 7-11, 7-13, 7-15 to 7-18 and 7-46 Machines.....
11402	828	Presser Bar for 7-1 to 7-4 and 7-29 Machines.....
11404	827	Presser Bar Guide Bracket with 159e, 353c and 453c, for 7-1 to 7-4 and 7-29 Machines.....
11405	830	Lifting Presser Bar Guide Bracket Guide for 7-5 to 7-8, 7-11, 7-13, 7-15 to 7-18 and 7-46 Machines.....
11405	830	Presser Bar Guide Bracket Guide for 7-1 to 7-4 and 7-29 Machines.....
11407	832	Presser Bar Lifter with 7958, 8761, 8763 and 43267, for 11408, obsolete.....
11408	832	Presser Bar Lifter Link, obsolete.....
11409	827	Lifting Presser Bar Spring for 7-5 to 7-8, 7-10, 7-11, 7-13, 7-15 to 7-18, 7-24, 7-46 and 7-47 Machines, and obsolete for 7-22 Machine.....

NO.	PLATE	NAME
11409	827	Presser Bar Spring for 7-1 to 7-4 and 7-29 Machines.....
11411	887	Lifting Presser Bar Spring Collar with 453c, for 7-11 and 7-46 Machines, and obsolete for 7-16 to 7-18 Machines.....
11411	887	Presser Bar Spring Collar with 453c, for 7-1 to 7-4 and 7-29 Machines.....
11412	827	Presser Foot with 362f, for 7-1 to 7-4 Machines.....
11415	—	Shuttle Race complete, Nos. 11416, 11417 and two 164e, obsolete.....
11416	832	Shuttle Race Frame for 11415.....
11417	829	“ “ Ring for 11415.....
11418	858	“ “ Slide (left) for 7-1 to 7-8, 7-10, 7-14, 7-16 to 7-18, 7-30, 7-35 and 7-47 Machines.....
11419	828	Shuttle Race Slide (right) obsolete.....
11420	—	Tension (wheel) complete for 7-1 to 7-8, 7-11, 7-13, 7-14, 7-15, 7-20, 7-32, 7-35 and 7-46 Machines, Nos. 8905, 11044, 11422, 11423, 58589 and two 8879....
11421	887	Tension Bracket for 7-1 to 7-8, 7-11, 7-13, 7-15 to 7-18, 7-29 and 7-46 Machines...
11422	888	Tension Spring for 11420.....
11423	888	“ Friction Washer (steel) for 11420, 12042 and 58317.....
11424	888	Thread Eyelet for 11502, 19919 and 58351
11424	888	“ “ (front of arm) for 7-1 to 7-4 and 7-29 Machines.....
11425	836	Thread Eyelet (side of arm) obsolete.....
11425	836	“ Retaining Thread Eyelet for 7-42 7-45 and 7-54 Machines.....
11426	—	Thread Retainer (long stud) complete for 7-42 to 7-45 and 7-54 Machines, Nos. 2103, 8905, 58600 and two 2102..
11428	827	Thread Take-up Cam with two 434c, for 7-1 to 7-8, 7-13 to 7-18, 7-20, 7-22, 7-24, 7-26, 7-29, 7-30, 7-35 to 7-37, 7-43, 7-50 to 7-52 and 7-55 Machines.....
11430	829	Thread Take-up Lever with 1518j and 1845, obsolete.....
11431	888	Thread Take-up Spring Regulator Plate for 7-1 to 7-8, 7-11, 7-13 to 7-18, 7-20, 7-29, 7-32, 7-35, 7-42 and 7-44 to 7-46 Machines.....
11432	—	Throat Plate Body for 11433 and 58241

NO.	PLATE	NAME
11433	4416	Throat Plate complete for 11369, 19524, for 7-1 to 7-8, 7-10 and 7-47 Machines, Nos. 219F, 11432 and 11434.....
11434	4416	Throat Plate Needle Plate (round needle hole) for 11433.....
11435	4416	Throat Plate Needle Plate (oblong needle hole) for 58241.....
11438	896	Balance Wheel with two 354c, for 58290, obsolete.....
11440	896	Driving Attachment Friction Pulley 7 in. diam., 1½ in. face, with 448c and 11441, for 19664, 19862, 58379, 58380, 58443 and 58508 to 58510.....
11441	849	Driving Attachment Friction Pulley Center Bearing for 11440.....
11442	896	Balance Wheel Friction Washer (paper) for 58289, 58290, 58336 and 122302....
11442	896	Driving Attachment Balance Wheel Friction Washer (paper) for 58336 and 122302..
11445	—	Belt Shifter complete for 7-4 Machine, Nos. 567D, 5668, 5672, 6439, 11446 to 11451, 11454, 11456, 11457, 11459 and two each 2117 and 11453, obsolete....
11446	890	Belt Shifter Chain Eyelet for 11445, 11945 and 19994.....
11446	890	Feed Reverse Stop Lever Spring Hook for 7-11 and 7-46 Machines.....
11447	874	Belt Shifter Chain Pulley for 11445 and 11945.....
11448	906	Belt Shifter Fork for 11445, obsolete.....
11449	906	" " Frame with 8804 and two 434c, for 11445, obsolete.....
11450	828	Belt Shifter Guide Rod for 11445 and 11945.....
11451	828	Belt Shifter Slide Rod for 11445, 11945 and 19994.....
11453	887	Belt Shifter Slide Rod Collar with two 448c, for 11445 and 11945.....
11453	887	Belt Shifter Slide Rod Spring Collar with two 448c, for 11445, 11945 and 19994..
11454	893	Belt Shifter Slide Rod Spring for 11445 and 19994.....
11456	906	Belt Shifter Pulley (tight) with two 354c, for 11445, obsolete.....
11457	906	Belt Shifter Pulley (loose) for 11445, obsolete.....

NO.	PLATE	NAME
11459	897	Belt Shifter Pulley (loose) Collar with two 448c, for 11445 and 19994.....
11463	851	Lifting Presser Bar Guide Bracket with 159E and 453c, for 7-11 and 7-46 Machines and obsolete for 7-5 to 7-8, 7-13 and 7-15 Machines.....
11465	853	Lifting Presser Bar Spring Bracket with 353c, for 7-5 to 7-8, 7-13 and 7-15 to 7-18 Machines.....
11466	853	Lifting Presser Bar Spring Bracket Set Screw Washer for 7-5 to 7-8, 7-13 and 7-15 to 7-18 Machines.....
11468	851	Vibrating Presser Bar Guide Bracket with 448c, for 11469 and 11724, obsolete....
11469	—	Vibrating Presser Bar Guide Bracket complete for 7-5 to 7-8, 7-13 and 7-15 to 7-18 Machines, Nos. 11468, 11470 and two 190E, obsolete.....
11470	851	Presser Bar Guide Bracket Cap for 11635
11470	851	Vibrating Presser Bar Guide Bracket Cap for 11469, obsolete.....
11472	853	Vibrating Presser Bar Spring Bracket for 14594.....
11473	853	Vibrating Presser Foot for 7-5 to 7-8 Machines, obsolete.....
11475	851	Lifting Presser Bar for 7-32, 7-40, 7-42, 7-44, 7-45, 7-53 and 7-55 Machines....
11476	850	Lifting Presser Bar Bell Crank for 7-32, 7-40, 7-42, 7-44, 7-45, 7-53 and 7-55 Machines.....
11478	850	Lifting Presser Bar Bracket with two 145E, for 7-40, 7-53 and 7-55 Machines
11479	852	Lifting Presser Bar Rock Shaft for 7-32, 7-40, 7-42, 7-44, 7-45, 7-53 and 7-55 Machines.....
11481	851	Lifting Presser Bar Rock Shaft Bracket for 7-32, 7-40, 7-53 and 7-55 Machines
11484	852	Lifting Presser Bar Rock Shaft Crank with 453c and 1850, for 7-32, 7-40, 7-42, 7-44, 7-45, 7-53 and 7-55 Machines....
11486	850	Lifting Presser Bar Rock Shaft Eccentric Strap with two each 141E and 1528c, for 7-32, 7-40, 7-42, 7-44, 7-45, 7-53 and 7-55 Machines.....
11487	853	Lifting Presser Bar Rock Shaft Eccentric Strap Hinge Screw Slide for 7-32, 7-40, 7-42, 7-44, 7-45, 7-53 and 7-55 Machines

NO.	PLATE	NAME
11488	853	Lifting Presser Bar Rock Shaft Eccentric Strap Hinge Screw Slide Washer for 7-32, 7-40, 7-42, 7-44, 7-45, 7-53 and 7-55 Machines.....
11489	852	Lifting Presser Bar Sleeve (lower) for 7-32, 7-40, 7-42, 7-44, 7-45, 7-53 and 7-55 Machines.....
11490	852	Lifting Presser Bar Sleeve (upper) for 11491.....
11491	—	Lifting Presser Bar Sleeve (upper) 11490 with 11492, for 7-40, 7-53 and 7-55 Machines.....
11492	853	Lifting Presser Bar Sleeve (upper) Cap for 11491 and 19913.....
11493	825	Lifting Presser Bar Spring (flat) for 7-32, 7-40, 7-42, 7-44, 7-45, 7-53 and 7-55 Machines.....
11494	850	Lifting Presser Bar Spring Bracket with 12232, for 7-32 and 7-40 Machines, obsolete.....
11495	9608	Thread Eyelet (side of arm) for 7-32, 7-40, 7-42, 7-44, 7-45, 7-53 and 7-55 Machines.....
11497	825	Oil Cup for 11921, obsolete.....
11500	851	Shuttle Race Slide (right) for 7-1 to 7-8, 7-14, 7-16 to 7-18, 7-30 and 7-35 Machines.....
11501	—	Tension Bracket and Vibrating Presser Bar Cap complete for 7-40, 7-53 and 7-55 Machines, Nos. 122E, 9525, 11502, 11506, 11936, 11937, 12042 and two 190E.....
11502	851	Tension Bracket and Vibrating Presser Bar Cap with 11424, for 11501.....
11503	—	Thread Retainer complete for 7-32, 7-40, 7-53 and 7-55 Machines, Nos. 2103, 8905, 58597 and two 2102.....
11505	851	Thread Take-up Cam with two 434c, for 7-32, 7-40, 7-42, 7-44, 7-45, 7-53 and 7-55 Machines.....
11506	853	Thread Take-up Spring for 11501.....
11509	853	Vibrating Presser Bar Cushion (rawhide) for 7-40, 7-53 and 7-55 Machines.....
11510	850	Vibrating Presser Bar Hinge Bracket with 145E, for 7-40, 7-53 and 7-55 Machines.....
11512	851	Vibrating Presser Bar Spring for 7-32, 7-40, 7-42, 7-44, 7-45, 7-53 and 7-55 Machines.....

NO.	PLATE	NAME
11514	855	Arm Shaft for 11628, for 7-10 Machine, obsolete.....
*11515	—	Arm Side Plate for 11628, obsolete.....
11517	854	Balance Wheel (two speed) with 347c, for 7-10 Machine.....
11518	859	Balance Wheel Key for 7-10 and 7-47 Machines.....
11519	858	Bed Bracket with wood screw 1¼ in. No. 14 R. H., for 7-10 Machine (Accessories).....
11520	854	Face Plate for 7-10 Machine, obsolete....
11521	4425	Feed Dog, 8 teeth (10 teeth to the inch) for bag handles, for 11556, for 7-10 and 7-47 Machines.....
11522	855	Lifting Presser Bar for 7-10, 7-22 and 7-24 Machines, obsolete.....
11523	856	Lifting Presser Bar Bell Crank for 7-10, 7-22, 7-24, 7-26, 7-36, 7-37, 7-47 and 7-50 to 7-52 Machines.....
11524	—	Lifting Presser Bar Bell Crank Adjusting Link for 11525.....
11525	856	Lifting Presser Bar Bell Crank Adjusting Link complete for 7-10, 7-22, 7-24, 7-26, 7-36, 7-37, 7-47 and 7-50 to 7-52 Machines, Nos. 1518i, 1828, 2718 and 11524.....
11526	889	Lifting Presser Bar Bell Crank Connecting Stud with two 858c, for 11527.....
11527	—	Lifting Presser Bar Bell Crank Connecting Stud complete for 7-10, 7-22, 7-24, 7-26, 7-36, 7-37, 7-47 and 7-50 to 7-52 Machines, Nos. 164E, 11526, and 11528....
11528	862	Lifting Presser Bar Bell Crank Connecting Stud Cap Screw Washer for 11527.....
11529	—	Lifting Presser Bar Lifter for 11530, obsolete.....
11530	856	Lifting Presser Bar Lifter 11529 with 11532 and 11533, for 7-10 Machine, obsolete..
11531	881	Lifting Presser Bar Lifter Bracket for 7-10, 7-22, 7-24, 7-26, 7-36 and 7-37 Machines, obsolete.....
11532	862	Lifting Presser Bar Lifter Friction Spring for 11530, obsolete.....
11533	862	Lifting Presser Bar Lifter Friction Spring Stud for 11530, obsolete.....
11534	862	Lifting Presser Bar Lifter Cap Screw Washer for 7-10 Machine obsolete.....
11535	862	Lifting Presser Bar Lifter Cap Screw Washer Steady Pin for 7-10 Machine, obsolete.....

242 NUMERICAL LIST OF PARTS

NO.	PLATE	NAME
11537	889	Lifting Presser Bar Spring Adjusting Block with 435c, for 7-10 Machine, obsolete.....
11538	855	Needle Bar for 7-10, 7-13, 7-15, 7-32 and 7-47 Machines.....
*11539	856	Needle Bar Connecting Link for 19981 and 58246.....
11542	—	Needle Clamp with 680f and 11385, for 11543, obsolete.....
11543	889	Needle Clamp complete for 7-10 Machine, Nos. 830f, 10107, 11542 and two 10106, obsolete.....
11544	854	Oil Cup Lamp Holder for 7-10 and 7-47 Machines.....
11545	858	Shuttle Race Slide (right) for 7-10 Machine, obsolete.....
11546	—	Thread Retainer complete for 7-10, 7-24 and 7-47 Machines, Nos. 2049, 2103, 8905, 11547, 58592 and two 2102.....
11547	859	Thread Retaining Bracket for 11546.....
11548	862	Face Plate Thread Eyelet for 11520, for 7-10 Machine, obsolete.....
11549	—	Thread Take-up Cam with two 434c, for 11550, obsolete.....
11550	854	Thread Take-up Cam 11549 with 2117, 11551, and two each 159e and 434c, for 7-10 Machine, obsolete.....
11551	4433	Lifting Presser Bar Bell Crank Lifting Cam for 11550, obsolete.....
11552	859	Thread Take-up Lever Spring for 7-10 Machine, obsolete.....
11553	859	Thread Take-up Lever Spring Regulator Plate for 7-10 Machine, obsolete.....
11554	862	Thread Take-up Staple for 7-10 Machine, obsolete.....
11555	—	Throat Plate Body for 11556.....
11556	4425	Throat Plate complete for 11521, for 7-10 and 7-47 Machines, Nos. 11555, 11557 and two 202f.....
11557	4425	Throat Plate Needle Hole Strip (round needle hole) for 11556.....
11558	848	Vibrating Presser Bar for 7-10 and 7-47 Machines.....
11559	4433	Vibrating Presser Bar Cap Bracket (upper) for 11911, 19555, 19755, 19960, 19962, 19963 and 58250.....

NUMERICAL LIST OF PARTS 243

NO.	PLATE	NAME
11560	4433	Vibrating Presser Bar Cap Bracket (lower) for 11911, 19555, 19960, 19962 and 58250.....
11561	859	Vibrating Presser Bar Guide Bracket for 7-10, 7-22, 7-24, 7-26, 7-36 and 7-37 Machines, obsolete.....
11563	862	Vibrating Presser Bar Spring Stud with 19877, for 7-10, 7-22, 7-24, 7-26, 7-36, 7-37, 7-47 and 7-50 to 7-52 Machines..
11564	862	Vibrating Presser Bar Spring Stud Spring for 7-10, 7-22, 7-24, 7-26, 7-36, 7-37, 7-47 and 7-50 to 7-52 Machines.....
11565	859	Vibrating Presser Bar Stop complete for 7-24 Machine, Nos. 682d, 6312, 11566 and 11567, obsolete.....
11566	862	Vibrating Presser Bar Stop Block for 11565, obsolete.....
11567	862	Vibrating Presser Bar Stop Block Washer (small) for 11565, obsolete.....
11568	4426	Vibrating Presser Foot (narrow) for 7-10 and 7-47 Machines.....
11569	4426	Vibrating Presser Foot (wide) for 7-10 and 7-47 Machines.....
11574	862	Needle Bar Thread Guard for 11538, for 7-10 Machine, obsolete.....
11575	856	Wrench for 611, for 7-10 Machine, obsolete
11576	857	Binder (adjustable) complete for 7-10 and 7-47 Machines, Nos. 207f, 3146, 7071, 11577 to 11579 and 11832.....
Nos. 11577 to 11579 FOR 11576		
11577	4415	Binder Bed.....
11578	4415	" " Spring Guide.....
11579	4415	" " " " Cam.....
*11584	—	Arm with 15404 and two 15405, for 7-11 and 7-46 Machines.....
11585	838	Arm Shaft for 7-11 Machine, obsolete....
11589	—	Feed Cam for 11590.....
11590	843	Feed Cam complete for 7-11 and 7-46 Machines, Nos. 155e, 161e, 761c, 11589 and 11591.....
11591	843	Feed Cam Clutch for 11590.....
11592	844	" Dog, 17 teeth (12 teeth to the inch) for 11638 and 19516, for 7-11, 7-13 and 7-15 Machines, obsolete.....
11593	838	Feed Forked Connection for 7-11, 7-13, 7-15 and 7-46 Machines.....

NO.	PLATE	NAME
11598	838	Feed Rock Shaft for 11599.....
11599	—	Feed Rock Shaft complete for 7-11, 7-13, 7-15 and 7-46 Machines, Nos. 11598 and 58447.....
11601	839	Feed Rock Shaft Crank with 445c, for 11812, obsolete.....
11602	840	Knee Lever for 11895, obsolete.....
11603	838	“ “ Connecting Rod for 7-11 Machine, obsolete.....
11604	—	Knee Plate for 11896, obsolete.....
11605	856	“ “ Bracket (left) for 11896, ob- solete.....
11606	879	Knee Plate Bracket Rivet for 11896, obsolete.....
11607	843	Switch Clutch for 7-11 and 7-46 Machines
11608	9616	“ “ Driver for 7-11 and 7-46 Machines.....
11610	843	Switch Clutch Lever with 1813, for 7-11 and 7-46 Machines.....
11611	9617	Switch Clutch Lever Bracket for 7-11 and 7-46 Machines.....
11612	9621	Switch Clutch Key for 7-11 and 7-46 Ma- chines.....
11613	840	Switch Lever for 7-11 Machine, obsolete..
11614	843	“ “ Bracket for 7-11 Machine, obsolete.....
11615	—	Switch Lever Connecting Rod for 11616, obsolete.....
11616	840	Switch Lever Connecting Rod 11615 with 11621 and 11624, for 7-11 Machine, obsolete.....
11617	843	Switch Lever Connecting Rod Guide for 7-11 Machine, obsolete.....
11618	843	Switch Lever Connecting Rod Guide Bracket for 7-11 Machine, obsolete....
11619	843	Switch Lever Connecting Rod Guide Cap for 7-11 Machine, obsolete.....
11620	843	Switch Lever Connecting Rod Guide Plate for 7-11 Machine, obsolete.....
11621	889	Switch Lever Connecting Rod Stop Pin for 11616, obsolete.....
11622	886	Switch Lever Spring for 7-11 Machine, obsolete.....
11623	843	Switch Ring for 7-11 Machine, obsolete...
11624	889	“ “ Point for 11616, obsolete....
11625	842	Shuttle Race Ring for 7-11 Machine, ob- solete.....

NO.	PLATE	NAME
11626	843	Strip Guide (right) for 7-11 and 7-46 Machines.....
11627	843	Strip Guide (left) for 7-11 and 7-46 Ma- chines.....
*11628	—	Arm with 11515, 15404 and two each 134E and 15405, for 7-10 Machine, obsolete..
11630	843	Thread Take-up Cam with two 434c, for 7-11 Machine, obsolete.....
11631	—	Throat Plate Body for 11638, obsolete....
11632	905	“ “ Needle Hole Strip for 11638, obsolete.....
11633	9627	Throat Plate Packing for 7-11 Machine, obsolete.....
11634	886	Presser Bar Guide Bracket with 446c and 1192c, for 11635.....
11635	—	Presser Bar Guide Bracket complete for 7-11 and 7-46 Machines, Nos. 11470, 11634 and two 190e.....
11637	861	Presser Foot for 7-11 Machine, obsolete..
11638	905	Throat Plate complete for 11592, for 7-11 Machine, Nos. 11631, 11632 or 11863 and two 401b, obsolete.....
11661	9608	Lifting Presser Bar Spring Guide Pin for 7-10, 7-22, 7-26, 7-30, 7-32, 7-36, 7-37, 7-40, 7-42 to 7-45, 7-47 and 7-50 to 7-55 Machines.....
11661	9608	Presser Bar Spring Guide Pin for 7-14, 7-20 and 7-35 Machines.....
11678	906	Balance Wheel with two 354c, for geared machine, obsolete.....
11680	840	Cloth Plate for 7-11, 7-13, 7-15 and 7-46 Machines.....
11686	848	Presser Foot with 362f, obsolete.....
11687	—	Throat Plate Body for 11688 and 11948, obsolete.....
11688	904	Throat Plate complete for 7-13 and 7-15 Machines, Nos. 11687, 11689 and two 401b, obsolete.....
11689	—	Throat Plate Needle Hole Strip for 11688, obsolete.....
11690	9627	Throat Plate Packing for 7-13 and 7-15 Machines, obsolete.....
*11691	—	Arm with 15404 and two 15405, for No. 8, for 7-14, 7-20 and 7-35 Machines, ob- solete.....
*11692	—	Arm Side Plate for 7-14 and 7-20 Ma- chines, obsolete.....

NO.	PLATE	NAME
11694	847	Feed Cam with two 445c, for 7-14 and 7-20 Machines, obsolete.....
11695	846	Feed Connecting Link, for 7-14 and 7-20 Machines, obsolete.....
11697	846	Feed Regulator with 453c, for 7-14 and 7-20 Machines, obsolete.....
11698	847	Feed Shaft for 7-14, 7-20 and 7-35 Machines.....
11698	847	Feed (upper) Shaft for 7-30, 7-43 and 7-54 Machines.....
11699	846	Feed Regulator Shaft Bracket for 7-14 and 7-20 Machines, obsolete.....
11700	—	Feed Regulator Shaft Crank with 453c, for 11701, obsolete.....
11701	884	Feed Regulator Shaft Crank 11700 with 1518j and 1845, for 7-14 and 7-20 Machines, obsolete.....
11702	863	Feed Shaft for 7-14 and 7-20 Machines, obsolete.....
11703	846	Feed Shaft Bracket (front) for 7-14 and 7-20 Machines, obsolete.....
11704	846	Feed Shaft Bracket (back) for 7-14 and 7-20 Machines, obsolete.....
11706	849	Feed Shaft Crank with 453c, for 7-14 and 7-20 Machines, obsolete.....
11708	846	Feed Regulator Shaft Driving Crank with 453c and 1804, for 7-14, 7-20 and 7-35 Machines.....
11708	846	Feed (upper) Regulator Shaft Driving Crank with 453c and 1804, for 7-30, 7-43 and 7-54 Machines.....
11709	849	Needle Plate for 7-14 and 7-20 Machines, obsolete.....
11710	848	Presser Bar Lifting Link for 7-14 and 7-20 Machines, obsolete.....
11711	884	Feed Point for 7-14 and 7-20 Machines, obsolete.....
11714	829	Shuttle Race Slide, obsolete.....
11715	846	Feed Bar for 7-14 and 7-20 Machines, obsolete.....
11716	—	Feed Bar Guide Bracket (lower) with 453c, for 11717, obsolete.....
11717	846	Feed Bar Guide Bracket (lower) complete for 7-14 and 7-20 Machines, Nos. 11716, 11718 and two 190e, obsolete.....
11718	—	Feed Bar Guide Bracket (lower) Cap with 9042, for 11717, obsolete.....

NO.	PLATE	NAME
11719	846	Feed Bar Guide Bracket (upper) for 7-14 and 7-20 Machines, obsolete.....
11720	874	Feed Bar Spring Bracket with 8077, for 7-14 and 7-20 Machines, obsolete.....
11721	874	Feed Bar Spring Bracket Block for 7-14 and 7-20 Machines, obsolete.....
11722	—	Vibrating Presser Bar for 19523, obsolete
11724	886	Vibrating Presser Bar Guide Bracket complete for 7-13 and 7-15 Machines, Nos. 11468, 11725 and two 190e, obsolete.....
11725	886	Vibrating Presser Bar Guide Bracket Cap with 9042, for 11724, obsolete.....
11726	848	Needle Bar for 7-16 to 7-18 Machines....
11727	4435	Shuttle Driver with 453c, for 7-16 to 7-18 Machines.....
11728	844	Vibrating Presser Foot for 7-13 and 7-15 Machines, obsolete.....
11736	—	Throat Plate Body for 11737, obsolete....
11737	875	Throat Plate complete for 11884, for 7-16 to 7-18 Machines, Nos. 219f, 11736 and 11738 or 11891, obsolete.....
11738	875	Throat Plate Needle Plate (large oblong needle hole) for 11737, obsolete.....
11739	886	Vibrating Presser Bar Spring Bracket with 9042, for 19523 and 19750.....
11740	879	Vibrating Presser Bar Spring Bracket Rivet for 19523 and 19750.....
11741	—	Gear Cover, obsolete.....
11744	4435	" Stud Washer, obsolete.....
11745	910	Pinion.....
*11746	—	Bed for 7-20 Machine.....
11748	891	Bobbin Winder complete, for machine on Stand No. 25205, Nos. 2460, 2461, 11749 and 11750, obsolete.....
11749	891	Bobbin Winder Frame for 11748, obsolete
11750	891	" " Spindle for 11748 and 11752, obsolete.....
11751	891	Bobbin Winder Spring for 11748, obsolete
11752	891	Bobbin Winder complete for Stand, Nos. 284d, 2460, 2461, 11750 and 11753, obsolete.....
11753	891	Bobbin Winder Frame for 11752, obsolete
11754	855	Bobbin Winder (hand) complete for Machine Bed, Nos. 2269, 11756, 11758 to 11761 and 11763 to 11765.....

NO.	PLATE	NAME
11756	—	Bobbin Winder Belt with 25028, for 11754
11758	858	" " Frame for 11754.....
11759	858	" " Pulley for 11754.....
11760	892	" " " Driving Wheel for 11754 and 11766.....
11761	4433	Bobbin Winder Pulley Driving Wheel Handle complete, for 11754 and 11766, Nos. 8380, 8382 and 11762.....
11762	893	Bobbin Winder Pulley Driving Wheel Handle Stud for 11761.....
11763	859	Bobbin Winder Pulley Driving Wheel Stud for 11754 and 11766.....
11764	862	Bobbin Winder Pulley Driving Wheel Stud Washer for 11754 and 11766.....
11765	858	Bobbin Winder Spindle for 11754.....
11766	855	Bobbin Winder (hand) complete for wood table, Nos. 528E, 2269, 11760, 11761, 11763, 11764 and 11768 to 11771.....
11768	—	Bobbin Winder Belt with 25028, for 11766
11769	892	" " Frame for 11766.....
11770	859	" " Pulley for 11766.....
11771	858	" " Spindle for 11766.....
11773	826	Crank Connecting Rod for 372, obsolete
11774	826	Feed Forked Connection for 372, obsolete
11775	835	" Connecting Link for 372, obsolete...
11776	831	" Regulator for 58, obsolete.....
11779	832	" Bar for 308, obsolete.....
11780	826	" Lifting Rock Shaft for 304, for 11781, obsolete.....
11781	—	Feed Lifting Rock Shaft complete, Nos. 11780 and 11783, obsolete.....
11783	9617	Feed Lifting Rock Shaft Crank with 453c and 1804, for 11781, obsolete.....
11785	837	Feed Lifting Rock Shaft Crank with 453c and 1844, obsolete.....
11786	835	Needle Bar Connecting Link for 375, obsolete.....
11788	837	Oscillating Shaft Crank with 453c and 1804, obsolete.....
11790	837	Oscillating Shaft Crank with 453c and 1844, obsolete.....
11791	831	Oscillating Rock Shaft for 304, obsolete...
11792	831	" " with 175E, 11399 and two each 11401 and 11793, for 564, obsolete.....
11793	837	Oscillating Rock Shaft Steel Plate for 11792 and 11860 to 11862, obsolete.....

NO.	PLATE	NAME
11794	834	Shuttle (cylinder) 3 in. diam., complete, Nos. 223F, 773F, 8961, 11795 to 11798 and 11910, obsolete.....
11795	836	Shuttle Frame for 11794, obsolete.....
11796	834	" Cylinder for 11794, obsolete.....
11797	834	" " Latch Spring for 11794, obsolete.....
11798	834	Shuttle Tension Spring for 11794, obsolete
11800	835	" Driver with 453c, obsolete.....
11801	837	" " Thread Pull-off, obsolete..
11803	829	Thread Take-up Lever with 1813, obsolete.....
11805	832	Thread Take-up Cam with two 434c, for 1813, obsolete.....
11806	836	Throat Plate for 11839, for 7-1 to 7-8 Machines, obsolete.....
11807	829	Assisting Presser Foot, obsolete.....
11808	829	" " Bar Lifting Link, obsolete.....
11809	835	Assisting Presser Bar Lifting Link Bracket, obsolete.....
11810	826	Feed Forked Connection for 372, obsolete
11811	826	" Rock Shaft for 11812, obsolete.....
11812	—	Feed Rock Shaft complete, Nos. 11601 and 11811, obsolete.....
11813	832	Feed Bar for 308, obsolete.....
11815	4497	Thread Take-up Cam with two 434c, for 1813, obsolete.....
11817	4497	Thread Take-up Cam with two 434c, for 1845, obsolete.....
11818	836	Assisting Presser Bar Spring, obsolete...
11819	4402	Feed Rock Shaft for 11820, obsolete.....
11820	—	" " " 11819 with 11379, obsolete.....
11821	4402	Feed Lifting Rock Shaft for 605, for 11822, obsolete.....
11822	—	Feed Lifting Rock Shaft 11821 with 11374, obsolete.....
11824	831	Oscillating Rock Shaft with 175E, 11399 and two each 11400 and 11401, for 605, obsolete.....
11829	829	Presser Bar Lifter with 8761 and 8763, for 11408, obsolete.....
11830	845	Feed Bar Bracket for 7-14 and 7-20 Machines, obsolete.....
11831	4484	Screw Driver (large) Accessories.....
11832	830	Shuttle Race Back for 11836 and 19552...

NO.	PLATE	NAME
11833	889	Shuttle Race Back Position Pin for 11836, 19552, 19579 and 19640.....
11835	—	Shuttle Race Body for 11836.....
11836	825	Shuttle Race complete for 7-1 to 7-8, 7-10, 7-11, 7-13 to 7-18, 7-30, 7-35, 7-40, 7-46, 7-47, 7-53 and 7-55 Machines, Nos. 32D, 11832, 11835, 19577 and two 11833.....
11837	825	Shuttle Race Frame with 11838, for 7-1, to 7-8, 7-10, 7-11, 7-13 to 7-18, 7-20, 7-24, 7-30, 7-32, 7-35, 7-46 and 7-47 Machines.....
11838	889	Shuttle Race Frame Position Pin for 11837 and 19952.....
11839	836	Feed Dog, 16 teeth (10 teeth to the inch) for 11806, for 7-1 to 7-8 Machines, obsolete.....
11841	827	Oscillating Rock Shaft for 11842, obsolete
11842	—	Oscillating Rock Shaft complete for 7-1 to 7-8, 7-10, 7-11, 7-13 to 7-18, 7-20, 7-22, 7-24, 7-29, 7-30, 7-32, 7-35, 7-36, 7-40, 7-42, 7-44 to 7-47, 7-53 and 7-55 Machines, Nos. 622c, 1508J, 11165, 11841 and 58293, obsolete.....
11843	826	Treadle Extension with 138E, obsolete....
11845	827	Thread Take-up Lever with 1995, for 7-1 to 7-8, 7-10, 7-11, 7-13 to 7-15, 7-20, 7-24, 7-32, 7-35 and 7-40 Machines, obsolete.....
11846	839	Feed Reverse Stop Lever with 1518J and 1892, for 7-11 and 7-46 Machines.....
11848	—	Oscillating Shaft Crank for 19696.....
11850	825	" " for 7-1 to 7-8, 7-10, 7-11, 7-13 to 7-18, 7-20, 7-24, 7-30, 7-32, 7-35, 7-40, 7-46, 7-47, 7-53 and 7-55 Machines
11852	833	Shuttle Cylinder for 19986.....
11853	833	" " Latch for 58294.....
11854	833	" " Spring for 58294..
11854	833	" (inside) Cylinder Latch Spring for 58514.....
11854	833	Shuttle (outside) Cylinder Latch Spring for 58519.....
11856	830	Shuttle Driver with 453c, for 7-1 to 7-8, 7-10, 7-11, 7-13 to 7-15, 7-20, 7-24, 7-30, 7-32, 7-35, 7-40, 7-46, 7-47, 7-53 and 7-55 Machines.....

NO.	PLATE	NAME
11857	—	Thread Take-up Cam with two 434c, for 11858.....
11858	910	Thread Take-up Cam complete for 7-10 and 7-47 Machines, Nos. 2022, 11857, 11859 and two 159E.....
11859	4433	Lifting Presser Bar Bell Crank Lifting Cam, for 11858.....
11860	831	Oscillating Rock Shaft with 175E, 11399 and two each 11401 and 11793, for 304 and 1804, obsolete.....
11861	4433	Oscillating Rock Shaft with 175E, 11399 and two each 11401 and 11793, for 304 and 1861, obsolete.....
11862	4433	Oscillating Rock Shaft with 175E, 11399 and two each 11401 and 11793, for 618 and 1861, obsolete.....
11863	905	Throat Plate Needle Hole Strip (oblong needle hole) for 11638, obsolete.....
11864	906	Driving Attachment Shaft Driving Pulley (sectional) 10 in. diam., 1¼ in. face, 1⅝ in. bore, with two 597c, for 19664 and 19802, obsolete.....
11867	857	Lifting Presser Bar Lifter for 19596, 19865, 19885, 58215 and 58217.....
11868	860	Lifting Presser Bar Lifter Hinge Pin for 19596, for 7-10 and 7-24 Machines, obsolete.....
11869	860	Lifting Presser Bar Spring Adjusting Block with 523c, for 7-10, 7-22 and 7-24 Machines, obsolete.....
11871	—	Tension (wheel) complete for 19865, 58215 and for 7-24 Machine, Nos. 8791, 8905, 11043, 11044, 58591 and two 8879.....
11872	861	Face Plate Thread Eyelet for 19865 and 58215.....
11873	861	Face Plate Thread Guard for 19596 and 19865, obsolete.....
11875	857	Thread Take-up Spring Regulator for 19596, 19865, 19885, 58215 and 58217..
11876	860	Thread Take-up Spring Thread Guard for 19865 and 58215.....
11877	914	Thread Take-up Spring (11506 light wire) obsolete.....
11878	838	Arm Shaft for 7-4, 7-8, 7-15, 7-18, 7-22, 7-24, 7-32, 7-40, 7-45 and 7-55 Machines
11879	—	Spool Holder Bracket for 11880, obsolete

252 NUMERICAL LIST OF PARTS

NO.	PLATE	NAME
11880	855	Spool Holder Bracket complete for 7-10 Machine, Nos. 11879 and 11881, obsolete.....
11881	857	Spool Holder Tension Spool Pin complete for 11880, 58230 and 58256, Nos. 851E, 1541E, 8018 and 8019.....
11882	4415	Binder Bed Spring Guide Cam Stud for 11576.....
11883	4457	Bracket, for securing machine to power table, obsolete.....
11884	875	Feed Dog, 14 teeth (10 teeth to the inch) for 7-16 to 7-18 Machines, obsolete....
11885	4455	Feed Dog (double) for 7-13 and 7-15 Machines, obsolete.....
11886	904	Feed Dog, 16 teeth (10 teeth to the inch) for 11888, for 7-1 to 7-8 Machines, obsolete.....
11887	—	Throat Plate Body for 11888, obsolete....
11888	904	Throat Plate complete for 11886, for 7-1 to 7-8 Machines, Nos. 219F, 11887 and 11889 or 11890, obsolete.....
11889	904	Throat Plate Needle Plate (round needle hole) for 11888, obsolete.....
11890	904	Throat Plate Needle Plate (oblong needle hole) for 11888, obsolete.....
11891	875	Throat Plate Needle Plate (small oblong needle hole) for 11737, obsolete.....
11892	829	Shuttle Race Ring, obsolete.....
11893	4455	Feed Dog, 14 teeth (10 teeth to the inch) for general work, for 7-10 Machine, obsolete.....
11894	914	Thread Take-up Spring (11052 light wire) obsolete.....
11895	840	Knee Lever 11602 with 11896, for 7-11 Machine, obsolete.....
11896	840	Knee Plate 11604 with 135E, 11605, 11897 and four 11606, for 11895, obsolete....
11897	856	Knee Plate Bracket (right) for 11896, obsolete.....
11898	860	Needle Bar Thread Eyelet for 7-10 Machine, obsolete.....
11900	4427	Feed Forked Connection Friction Spring Extension (left) for 7-11 Machine, obsolete.....
11906	827	Lifting Presser Bar Lifting Link for 7-5 to 7-8, 7-11, 7-16 to 7-18 and 7-46 Machines.....

NUMERICAL LIST OF PARTS 253

NO.	PLATE	NAME
11906	827	Presser Bar Lifting Link for 7-1 to 7-4 and 7-29 Machines.....
11907	842	Lifting Presser Bar Lifting Link for 7-40, 7-53 and 7-55 Machines.....
11909	830	Lifting Presser Bar Lifter with 8761 and 8763, for 7-5 to 7-8, 7-11, 7-13, 7-15 to 7-18, 7-30, 7-32, 7-40, 7-42 to 7-46 and 7-53 to 7-55 Machines.....
11909	830	Presser Bar Lifter with 8761 and 8763, for 7-1 to 7-4, 7-14, 7-15, 7-20, 7-29 and 7-35 Machines.....
11910	7268	Shuttle Bobbin for 11794, 19636, 58525 and 58526.....
11910	833	Shuttle (inside) Bobbin for 58516.....
11910	833	" (outside) Bobbin for 58521.....
*11911	—	Arm with 11559, 11560, 15404 and two each 128E, 612E and 15405, for No. 8, for 7-10 Machine, obsolete.....
11912	915	Arm Shaft for 7-10 Machine.....
11913	825	" Side Cover for 7-1 to 7-8, 7-10, 7-11, 7-13, 7-15 to 7-18, 7-22, 7-24, 7-26, 7-29, 7-32, 7-36, 7-37, 7-40, 7-42, 7-44 to 7-47, 7-50 to 7-52, 7-53 and 7-55 Machines...
11914	839	Feed Reverse Lever Connection for 7-11 and 7-46 Machines.....
11915	841	Feed Reverse Lever for 19505.....
11916	849	Needle Plate for 7-14, 7-30 and 7-35 Machines.....
11917	825	Oil Cup Cover for 11920, 11921, 19534 and 58254.....
11918	888	Oil or Wax Stripper Washer (steel) for 11917, for 11920, 11921, 19534 and 58254.....
11919	888	Oil Cup Thread Eyelet for 58254, obsolete
11920	855	Oil Cup complete for 7-10 Machine, Nos. 2205, 8482, 9084, 11387, 11917, 11918, two 8953 and three 207F, obsolete.....
11921	825	Oil Cup complete for 7-1 to 7-8, 7-11, 7-13, 7-15 to 7-18, 7-22, 7-24, 7-26, 7-29, 7-32, 7-36, 7-37, 7-40, 7-42 and 7-44 to 7-46 Machines, Nos. 2205, 8482, 9084, 11497, 11917, 11918, two 8953 and three 207F, obsolete.....
*11922	—	Bed for 7-29 Machine.....
11928	842	Needle Bar for 7-29 Machine.....
11929	916	Oscillating Shaft for 7-29 Machine.....
11930	—	" " Crank for 19697.....

NO.	PLATE	NAME
11932	882	Shuttle Driver with 445c, for 7-29 Machine
11933	882	" Race with 11934 and four 164E, for 7-29 Machine.....
11934	882	Shuttle Race Ring for 11933.....
11936	852	Thread Take-up Spring Regulator Plate for 11501.....
11937	853	Thread Take-up Spring Staple for 11501..
11939	9608	Vibrating Presser Bar Spring Adjusting Staple for 7-40, 7-53 and 7-55 Machines
11940	896	Belt Shifter Fork for 11945 and 19994....
11941	896	" " Frame with 8804 and two 434c, for 11945 and 19994.....
11942	828	Belt Shifter Slide Rod Spring for 11945...
11945	—	Belt Shifter complete for 7-4, 7-8, 7-15, 7-18, 7-22, 7-24, 7-32, 7-40, 7-45 and 7-55 Machines, Nos. 567D, 4885, 6439, 11446, 11447, 11450, 11451, 11940 to 11942, 58408, 58409 and two each 2117 and 11453.....
11946	842	Guide with Ridge for 7-11 Machine, obsolete.....
11947	—	Throat Plate Needle Hole Strip with Ridge for 11948, obsolete.....
11948	844	Throat Plate 11687 with 11947 and two 401D, for 7-11 Machine, obsolete.....
11949	839	Presser Bar for 7-11 and 7-46 Machines and obsolete for 7-5 to 7-8 Machines...
11949	839	Vibrating Presser Bar for 7-16 to 7-18 Machines, obsolete.....
11950	888	Thread Eyelet for 11503, for 7-32, 7-40, 7-53 and 7-55 Machines.....
11950	888	Thread Eyelet (side of arm) for 7-1 to 7-8, 7-11, 7-13 to 7-18, 7-20, 7-29, 7-30, 7-32, 7-35 and 7-46 Machines.....
11950	888	Thread Retaining Thread Eyelet for 11041, for 7-43 and 7-54 Machines.....
12002	7268	Shuttle Cylinder Latch Pin for 58294 and 58524.....
12002	833	Shuttle (inside) Cylinder Latch Pin for 58514.....
12002	833	Shuttle (outside) Cylinder Latch Pin for 58519.....
12042	—	Tension (wheel) complete for 11501, Nos. 8791, 8905, 11044, 11423, 58598 and two 5983.....
12232	4492	Lifting Presser Bar Spring Guide Pin for 11494, obsolete.....

NO.	PLATE	NAME
12596	879	Buff Wheel Clamp Carrier Cap Pin for 7-24 Machine, obsolete.....
13175	4443	Feed Dog Carrier Spring for 7-32 Machine
13351	—	Chain, length 46 in. to 55 in., with 56864 and 56865, for 19521 and 19648.....
14592	922	Vibrating Presser Bar for 26799 and for 7-5 to 7-8 and 7-16 to 7-18 Machines..
14593	4401	Vibrating Presser Bar Guide Bracket with 448c and 1192c, for 14594 and 19752..
14594	—	Vibrating Presser Bar Guide Bracket complete for 7-5 to 7-8 and 7-16 to 7-18 Machines, Nos. 231c, 11472, 14593, 14595 and two 190E.....
14595	4401	Vibrating Presser Bar Guide Bracket Cap for 14594.....
14596	862	Vibrating Presser Bar Hinge Pin for 7-5 to 7-8, 7-13 and 7-15 to 7-18 Machines..
14597	4416	Vibrating Presser Foot for 26793, 28997, 36181 and for 7-5 to 7-8 and 7-16 to 7-18 Machines.....
14785	4454	Driving Attachment Lever Spring Hook (for machine on top of table) for 19664, 19862, 58379, 58380, 58443 and 58508 to 58510.....
*15404	—	Trade Mark for 11351, 11584, 11628, 11691, 11911, 19501, 19502, 19555, 19755, 19898, 19959 to 19963, 19965, 58250, 58274, 58285 and 58339.....
15405	4492	Bobbin Winder Friction Pulley Ring Rivet for 43270.....
15405	4492	Trade Mark Rivet for 11351, 11584, 11628, 11691, 11911, 19501, 19502, 19555, 19755, 19898, 19959 to 19963, 19965, 58250, 58274, 58285 and 58339.....
16901	9622	Shuttle Bobbin for 43285.....
16901	9622	" (inside) Bobbin for 43275 and 58358.....
16901	9622	Shuttle (outside) Bobbin for 43283 and 58360.....
17547	4492	Bobbin Winder Thread Unwinder Tension Thread Guard for 60609.....
17547	4492	Thread Unwinder Tension Thread Guard for 60609 and 60611.....
*19501	—	Arm with 15404 and two 15405, for No. 8, for 7-1 to 7-8, 7-13, 7-15 to 7-18 and 7-29 Machines, obsolete.....

NO.	PLATE	NAME
*19502	—	Arm with 15404 and two 15405, for 7-32, 7-40, 7-53 and 7-55 Machines.....
19503	841	Feed Bar for 7-11, 7-13, 7-15 and 7-46 Machines.....
Nos. 19504 TO 19510 FOR 7-11 AND 7-46 MACHINES		
19504	847	Feed Forked Connection Friction Spring
19505	841	Feed Reverse Lever complete, Nos. 3146, 11915 and 19507.....
19506	861	Feed Reverse Lever Bracket.....
19507	841	“ “ “ Handle for 19505....
19508	841	“ “ “ Stop Lever Bracket.....
19509	890	“ “ “ “ Cushion (raw-hide).....
19510	886	Feed Reverse Stop Lever Spring.....
19511	861	“ “ “ “ “ Hook for 7-11 Machine, obsolete.....
19512	842	Lifting Presser Bar 11402 with 2049 and 19517, for 7-11 and 7-46 Machines.....
19513	842	Thread Take-up Cam with two 434c, for 7-11 and 7-46 Machines.....
19514	—	Throat Plate Body for 19516, obsolete....
19515	—	“ “ Needle Hole Strip for 19516, obsolete.....
19516	844	Throat Plate complete, for 11592, for 7-11 Machine, Nos. 19514, 19515 and two 401D, obsolete.....
19517	4435	Lifting Collar with 453c, for 19512 and 19521.....
19518	838	Foot Lifter Lifting Lever for 19521 and 19648, obsolete.....
19519	839	Lifting Lever Bracket for 19521.....
19520	860	“ “ Spring for 19521 and 19648
19521	—	Foot Lifter complete for 7-11 and 7-46 Machines, Nos. 32D, 134E, 2049, 2117, 4885, 8055, 13351, 19517, 19519, 19520 and 58310.....
19522	875	Vibrating Presser Foot for 7-16 to 7-18 Machines, obsolete.....
19523	839	Vibrating Presser Bar 11722 with 11739 and two 11740, for 7-13 and 7-15 Machines, obsolete.....
19524	875	Feed Dog, 14 teeth (10 teeth to the inch) for general work, for 11433 and 58241, for 7-10 and 7-47 Machines.....
19525	847	Arm Side Cover for 7-14, 7-20 and 7-35 Machines.....

NO.	PLATE	NAME
19526	847	Feed Cam with two 445c, for 7-14 and 7-20 Machines, obsolete.....
19527	845	Feed Connecting Link for 7-14, 7-20 and 7-35 Machines.....
19527	845	Feed (upper) Connecting Link for 7-30, 7-43 and 7-54 Machines.....
19528	865	Feed Regulator with 231c and 453c, for 7-14, 7-20 and 7-35 Machines.....
19528	865	Feed (upper) Regulator with 231c and 453c, for 7-30, 7-43 and 7-54 Machines
19529	9621	Feed Regulator Adjusting Screw Sleeve for 7-14, 7-20 and 7-35 Machines.....
19529	9621	Feed (upper) Regulator Adjusting Screw Sleeve for 7-30, 7-43 and 7-54 Machines
19530	873	Feed Regulator Shaft for 7-14, 7-20 and 7-35 Machines.....
19531	865	Feed Shaft Crank with 453c, 1518J and 1845, for 7-14, 7-20 and 7-35 Machines
19531	865	Feed (upper) Shaft Crank with 453c, 1518J and 1845, for 7-30 Machine.....
19532	869	Feed Shaft Driving Crank with 453c, for 7-14, 7-20 and 7-35 Machines.....
19532	869	Feed (upper) Shaft Driving Crank with 453c, for 7-30, 7-43 and 7-54 Machines
19533	863	Oil Cup for 19534, obsolete.....
19534	863	Oil Cup complete for 7-14, 7-20, 7-27, 7-30 and 7-35 Machines, Nos. 2205, 8482, 9084, 11917, 11918, 19533, two 8953 and three 207F, obsolete.....
19535	—	Lifting Presser Bar for 19536.....
19535	—	Presser Bar for 19536, obsolete.....
19536	848	Lifting Presser Bar 19535 with 64052, for 7-30, 7-43 and 7-54 Machines.....
19536	848	Presser Bar 19535 with 64052, for 7-14 and 7-20 Machines, obsolete.....
19538	845	Presser Bar Lifting Bell Crank for 7-14, 7-20 and 7-35 Machines.....
19539	—	Presser Bar Lifting Bell Crank Adjusting Link for 19540.....
19539	—	Lifting Presser Bar Bell Crank Adjusting Link for 19540.....
19540	845	Lifting Presser Bar Bell Crank Adjusting Link complete for 19681, Nos. 1518J, 1828, 2718 and 19539.....
19540	845	Presser Bar Lifting Bell Crank Adjusting Link complete, for 7-14, 7-20 and 7-35 Machines, Nos. 1518J, 1828, 2718 and 19539.....

NO.	PLATE	NAME
19541	848	Lifting Presser Bar Lifting Link for 7-30 Machine.....
19541	848	Presser Bar Lifting Link for 7-14, 7-20 and 7-35 Machines.....
19542	874	Tension Bracket for 7-14, 7-20 and 7-35 Machines.....
19543	884	Thread Take-up Spring Staple for 7-14, 7-20 and 7-35 Machines.....
19544	845	Feed Bar for 7-14, 7-20 and 7-35 Machines.....
19544	845	Feed (upper) Bar for 7-30 Machine.....
19545	884	" Bar Guide Bracket (upper) for 7-14, 7-20 and 7-35 Machines.....
19545	884	Feed (upper) Bar Guide Bracket (upper) for 7-30 Machine.....
19546	845	Feed Bar Guide Bracket (lower) with 456c and 1192c, for 19726.....
19546	845	Feed (upper) Bar Guide Bracket (lower) with 456c and 1192c, for 19726.....
19547	845	Feed Bar Guide Bracket (lower) Cap for 19726.....
19547	845	Feed (upper) Bar Guide Bracket (lower) Cap for 19726.....
19548	845	Feed Bar Hinge Bracket Guide Plate for 7-14, 7-20 and 7-35 Machines.....
19549	873	Shuttle Race Body for 19552.....
19550	873	" " Cap for 19551.....
19551	—	Shuttle Race Cap complete for 19552, Nos. 11040, 19550 and two 664J.....
19552	—	Shuttle Race complete for 7-20 Machine, Nos. 32D, 11832, 19549, 19551, 19577 and two each 96D and 11833.....
19553	873	Shuttle Race Slide for 7-20 Machine.....
19554	874	Needle Plate for 7-20 Machine.....
*19555	—	Arm with 11559, 11560, 15404 and two each 128E, 612E and 15405, for No. 8, for 7-22, 7-24 and 7-36 Machines, obsolete.....
*19556	—	Bed for 7-22, 7-36, 7-42, 7-44 and 7-45 Machines.....
19558	863	Face Plate for 19596, obsolete.....
19559	873	Feed Bar for 7-22, 7-36 and 7-42 Machine, obsolete.....
19560	868	Feed Dog, 13 teeth (10 teeth to the inch) for 7-22, 7-36 and 7-42 Machines, and for 26789 for 7-22 and 7-36 Machines, obsolete.....

NO.	PLATE	NAME
19563	848	Needle Bar for 7-22 Machine, obsolete....
*19564	869	" " Connecting Link for 58203, for 7-30 Machine.....
19565	869	Needle Bar Connecting Stud with 129E and 445E, for 58203.....
19566	865	Needle Clamp with two 207F, for 7-22 Machine, obsolete.....
19567	863	Oscillating Shaft for 7-22, 7-36, 7-42, 7-44 and 7-45 Machines.....
19572	864	Shuttle Driver with 445c, for 7-22, 7-36, 7-42, 7-44 and 7-45 Machines.....
19573	9614	Shuttle (inside) Frame for 58514....
19574	9614	" (outside) Frame for 58519....
19575	864	" Race Back (inside) for 19579
19576	864	" " (outside) for 19579
19577	864	" " " Spring for 11836, 19552, 19579 and 19640.....
19578	864	Shuttle Race Body for 19579.....
19579	—	Shuttle Race complete for 7-22, 7-36, 7-42, 7-44 and 7-45 Machines, Nos. 19575, 19576, 19578, two each 32D, 19577 and four 11833.....
19583	869	Face Plate Thread Eyelet for 19596 and 19885, obsolete.....
19584	869	Thread Eyelet (double) top of arm, for 7-22, 7-26, 7-36, 7-37 and 7-50 to 7-52 Machines.....
19585	869	Thread Retaining Bracket for 19587.....
19586	865	" " Thread Guide Pin for 19587.....
19587	—	Thread Retainer complete for 7-22, 7-26, 7-36, 7-37 and 7-50 to 7-52 Machines, Nos. 19585, 19586, two each 2103, 6312, 8905, 58592 and four 2102.....
19589	864	Thread Take-up Lever with 1995, for 7-22 and 7-36 Machines, obsolete.....
19590	865	Face Plate Thread Guard for 19596, 19885 and 58217.....
19591	—	Throat Plate Body for 19593.....
19592	868	" " Needle Hole Strip (right) for 19593.....
19593	868	Throat Plate complete for 58328, for 7-22, 7-36, 7-42, 7-44 and 7-45 Machines, Nos. 19591, 19592, 19997 and four 401D
19594	4427	Vibrating Presser Bar for 7-22 and 7-36 Machines.....

NO.	PLATE	NAME
19595	884	Vibrating Presser Foot for 7-22, 7-26, 7-36, 7-37 and 7-50 to 7-52 Machines..
19596	---	Face Plate complete for 7-22 Machine, Nos. 190E, 910c, 11867, 11868, 11873, 11875, 19558, 19583, 19590, 19701, 58579 or 58580 and two each 164E and 41544, obsolete.....
*19597	---	Bed for 7-24 and 7-32 Machines.....
*19598	---	" Extension with 19633, for 7-24 and 7-32 Machines.....
19599	876	Buff Wheel Clamp Carrier with 19614, for 7-24 Machine, obsolete.....
19600	878	Buff Wheel Clamp Carrier Cap for 7-24 Machine, obsolete.....
19601	876	Buff Wheel Clamp Carrier Locking Rack with 19614, for 7-24 Machine, obsolete
19602	876	Buff Wheel Clamp Carrier Locking Rack Bracket with two 453c, for 7-24 and 7-32 Machines.....
19603	878	Buff Wheel Clamp Carrier Locking Rack Bracket Hinge Pin for 7-24 and 7-32 Machines.....
19604	---	Buff Wheel Clamp Carrier Locking Rack Bracket Latch complete for 7-24 and 7-32 Machines, Nos. 19605 to 19608..
Nos. 19605 to 19608 FOR 19604		
19605	877	Buff Wheel Clamp Carrier Locking Rack Bracket Latch Body with 453c.....
19606	880	Buff Wheel Clamp Carrier Locking Rack Bracket Latch Pin.....
19607	880	Buff Wheel Clamp Carrier Locking Rack Bracket Latch Pin Head.....
19608	879	Buff Wheel Clamp Carrier Locking Rack Bracket Latch Spring.....
19609	881	Buff Wheel Clamp Carrier Sliding Flange with 453c, for 7-24 and 7-32 Machines..
19610	880	Buff Wheel Clamp Carrier Sliding Flange Shaft for 7-24 Machine, obsolete.....
19611	880	Buff Wheel Clamp Carrier Sliding Flange Gear with 462c, for 7-24 and 7-32 Machines.....
19611	880	Buff Wheel Clamp Spindle Gear with 462c, for 7-24 and 7-32 Machines.....
19612	876	Buff Wheel Clamp Carrier Sliding Rack with 19613, for 7-24 Machine, obsolete

NO.	PLATE	NAME
19613	879	Buff Wheel Clamp Carrier Sliding Rack Spring Hook for 19612, obsolete.....
19614	879	Buff Wheel Clamp Carrier Hook for 9159.....
19614	879	Buff Wheel Clamp Carrier Sliding Rack Spring Hook for 19601, obsolete.....
19614	879	Buff Wheel Clamp Carrier Weight Connection Hook for 19599, obsolete.....
19614	879	Thread Take-up Spring Hook for 19691 and 19906.....
19615	880	Buff Wheel Clamp Carrier Stop for 7-24 Machine, obsolete.....
Nos. 19616 TO 19619 FOR 7-24 AND 7-32 MACHINES		
19616	878	Buff Wheel Clamp Carrier Stop Plate..
19617	878	" " " " Weight (3¼ lbs.) with 19624 and 19625.....
19618	878	Buff Wheel Clamp Carrier Weight (4½ lbs.) with 19624 and 19625.....
19619	---	Buff Wheel Clamp Carrier Weight Connection (belt) with 19621.....
19620	879	Buff Wheel Clamp Carrier Weight Connection Guide Pin for 19641 and 19915
19621	904	Buff Wheel Clamp Carrier Weight Connection Hook for 19619.....
19622	881	Buff Wheel Clamp Carrier Weight Connection Pulley for 7-24 Machine, obsolete.....
19623	880	Buff Wheel Clamp Carrier Weight Connection Pulley Bracket for 7-24 and 7-32 Machines.....
19624	881	Buff Wheel Clamp Carrier Weight Eyelet for 19617 and 19618.....
19625	881	Buff Wheel Clamp Carrier Weight Eyelet Hook for 19617 and 19618.....
19626	880	Buff Wheel Clamp Spindle with three 19627, for 7-24 Machine, obsolete.....
19627	879	Buff Wheel Clamp Spindle Spur for 19626, obsolete.....
19628	880	Buff Wheel Thumb Screw Washer for 7-24, 7-32, 7-40, 7-53 and 7-55 Machines
19629	4430	Cloth Plate for 7-24 Machine, obsolete...
19630	877	Feed Bar for 7-24 and 7-32 Machines.....
19631	879	" Dog, 5 teeth (10 teeth to the inch) for 19643, for 7-24 Machine, obsolete...
19632	877	Feed Dog Carrier with 8077, for 7-24 and 7-32 Machines.....

NO.	PLATE	NAME
19633	879	Feed Dog Carrier Spring Hook for 19598.
Nos. 19634 TO 19636 FOR 7-24 AND 7-32 MACHINES		
19634	880	Guide Pin for circular stitching.....
19635	876	" Plate for circular stitching.....
19636	4429	Shuttle (cylinder) 3 in. diam., complete, Nos. 8961, 11910, 19986 and 58294.....
19637	881	Shuttle Frame for 58294.....
19638	877	" Race Back for 19640.....
19639	877	" " Body for 19640.....
19640	—	Shuttle Race complete for 7-24 and 7-32 Machines, Nos. 32D, 19577, 19638, 19639 and two 11833.....
Nos. 19641 TO 19645 FOR 7-24 MACHINE, OBSOLETE		
19641	—	Throat Plate Body with 19620, for 19643.
19642	879	" " Needle Hole Strip for 19643
19643	879	Throat Plate complete for 19631, Nos. 19641, 19642 and two 401D.....
19644	876	Vibrating Presser Bar.....
19645	879	" " and Stretching Foot....
19647	879	" " " " "Spring Stud for 7-24 and 7-32 Machines.....
19648	—	Foot Lifter complete for 7-14, 7-20, 7-27, 7-30, 7-35 and 7-43 Machines, Nos. 32D, 4885, 8055, 13351, 19520, 58311 and 64052.....
19650	907	Roller Arm for 19652.....
19651	907	" " Bracket with 362F, for 19652
19652	4422	Roller Presser complete, 1 $\frac{3}{4}$ in. roller, for 7-1 to 7-4 Machines, Nos., 191F, 423F, 1520F, 1929, 8773, 19650, 19651 and two each 315F and 1518J.....
Nos. 19653 TO 19661 FOR 7-10 AND 7-47 MACHINES		
19653	908	Guide Body for 19656.....
19654	908	" Slide for 19656.....
19655	908	" " Clamping Plate for 19656 and 19725.....
19656	908	Guide (adjustable) complete, for traces, Nos. 283D, 19653 to 19655 and two 86D
19657	908	Shuttle Race Slide (back) for 19656 and 19725.....
19657	908	Shuttle Race Slide (right).....
19658	909	Guide, for stitching round eye flaps, for 19659.....

NO.	PLATE	NAME
19659	909	Vibrating Presser Foot, for blinds and stitching round eye flaps.....
19660	909	Vibrating Presser Foot, for stitching bag and trunk handles.....
19661	909	Vibrating Presser Foot, for stitching over rounded traces of any width.....
19662	906	Driving Attachment Lever for 58378, obsolete.....
19663	906	Driving Attachment Lever Bracket for 58286 and 58378, obsolete.....
19664	—	Driving Attachment complete for 19699, for 7-3, 7-7, 7-13, 7-14, 7-17, 7-20, 7-24, 7-29, 7-30, 7-36 and 7-44 Machines, and for 11585 for 7-11 Machine, Nos. 1520I, 6055, 8873, 11440, 11864, 14785, 5820I, 58378 and 126210, obsolete.....
19668	911	Arm Side Cover for 7-30, 7-43 and 7-54 Machines.....
Nos. 19669 TO 19674 FOR 7-43 AND 7-54 MACHINES		
19669	911	Feed (upper) Bar.....
19670	912	" " Guide Bracket (lower) with 456c, for 19671.....
19671	—	Feed (upper) Bar Guide Bracket (lower) complete, for 1 in. and 1 $\frac{1}{8}$ in. gauges, Nos. 19670, 19672 and two 190E.....
19672	912	Feed (upper) Bar Guide Bracket (lower) Cap for 19671.....
19673	911	Feed (upper) Bar Guide Bracket (upper) for 1 in. and 1 $\frac{1}{8}$ in. gauges.....
19674	911	Feed (upper) Bar Hinge Bracket with 145E, 795c and two 445c.....
19675	911	Feed (upper) Bar Hinge Bracket Guide Plate for 7-30, 7-43 and 7-54 Machines
19676	910	Feed (upper) Cam with two 445c, for 7-30 and 7-43 Machines, obsolete.....
19677	910	Feed (upper) Regulator Shaft for 7-30, 7-43 and 7-54 Machines.....
19678	912	Feed (upper) Shaft Crank with 453c, 1518J and 1845, for 7-43 and 7-54 Machines.....
19680	910	Lifting Presser Bar Bell Crank for 19681
19681	—	Lifting Presser Bar Bell Crank complete for 7-30, 7-43 and 7-54 Machines, Nos. 611c, 19540 and 19680.....

NO.	PLATE	NAME
19682	913	Lifting Presser Bar Bell Crank Connecting Stud with 445c and 523c, for 7-30, 7-43 and 7-54 Machines.....
19683	913	Lifting Presser Bar Lifting Link for 7-43 and 7-54 Machines.....
19684	913	Tension Friction Washer (steel) for 19701 and 19889.....
19685	913	Tension Screw Stud Flange for 19701 and 19889.....
19686	913	Tension Spring for 19701 and 19889.....
19687	913	" Thread Guard for 7-43 and 7-54 Machines.....
19689	914	Thread Eyelet (double) top of arm, for 7-42 to 7-45 and 7-54 Machines.....
19690	914	Thread Take-up Spring for 7-30, 7-42 to 7-45 and 7-54 Machines.....
19691	914	Thread Take-up Spring Lever with 19614 and 19793, for 7-43 and 7-54 Machines.
19692	914	Thread Take-up Spring Lever Regulator for 7-43 and 7-54 Machines.....
19693	914	Thread Take-up Spring Lever Washer for 7-43 and 7-54 Machines.....
19693	914	Thread Take-up Spring Washer for 7-42, 7-44 and 7-45 Machines.....
19694	914	Thread Take-up Spring Hook for 19675, for 7-43 and 7-54 Machines.....
19696	4421	Oscillating Shaft Crank complete for 7-1 to 7-8, 7-10, 7-11, 7-13 to 7-18, 7-20, 7-22, 7-24, 7-30, 7-32, 7-35, 7-36, 7-40, 7-42, 7-44 to 7-47, 7-53 and 7-55 Machines, Nos. 453c, 1513j, 5868 and 11848.....
19697	4421	Oscillating Shaft Crank complete for 7-29 Machine, Nos. 453c, 1513j, 5868 and 11930.....
19698	4401	Feed Dog, 26 teeth (16 teeth to the inch) for 7-11, 7-13 and 7-15 Machines, obsolete.....
19699	915	Arm Shaft for 7-3, 7-7, 7-13, 7-14, 7-17, 7-20, 7-24, 7-29, 7-30 and 7-36 Machines, obsolete.....
19700	915	Arm Shaft for 11358, for 7-11 Machine, obsolete.....
19701	—	Tension (wheel) complete for 19596, 19885, 58217 and for 7-26 and 7-37 Machines, Nos. 8787, 11241, 19684 to 19686, 58593 and two each 8879 and 58795.....

NO.	PLATE	NAME
19702	890	Needle Clamp with 680f and 11385, for 7-1 to 7-8, 7-10, 7-11, 7-13 to 7-18, 7-20, 7-24, 7-29, 7-32, 7-35, 7-40, 7-46, 7-47, 7-53 and 7-55 Machines.....
Nos. 19704 to 19711 FOR 7-29 MACHINE		
19704	916	Cloth Plate.....
19705	917	Feed Dog, 8 teeth (7 teeth to the inch) for 19711 and 58386.....
19706	—	Presser Foot Plate for 19708.....
19707	—	" " Shank for 19708.....
19708	7821	Presser Foot (spring hinged) complete, Nos. 362f, 8582, 19706, 19707 and 25837.....
19709	—	Throat Plate Body for 19711 and 58386..
19710	917	" " Needle Hole Strip for 19711
19711	917	Throat Plate complete, for Nos. 26 and 27 Needles, for 19705, Nos. 19709, 19710 and two 389b.....
19718	920	Presser Foot for 26789.....
19719	921	" " for sewing straps with buckles on horse blankets, for 7-14, 7-20 and 7-35 Machines.....
19720	921	Presser Foot (stitch set) with extended toe on right hand side, for 7-14, 7-20 and 7-35 Machines.....
19720	921	Lifting Presser Foot (stitch set) with extended toe on right hand side, for 19900, for 7-30 Machine.....
19721	921	Lifting Presser Foot (stitch set) for stitching cruppers, for 19900, for 7-30 Machine.....
19721	921	Presser Foot (stitch set) for stitching cruppers, for 7-14, 7-20 and 7-35 Machines.....
19722	921	Lifting Presser Foot (stitch set) double toe, for 19900, for 7-30 Machine.....
19722	921	Presser Foot (stitch set) double toe, for 7-14, 7-20 and 7-35 Machines.....
19723	908	Guide Body for 19725.....
19724	908	" Slide for 19725.....
19725	908	Guide (adjustable) complete, for round lines, for 7-14, 7-20 and 7-35 Machines, Nos. 283b, 19655, 19723, 19724 and two 86b.....
19726	—	Feed Bar Guide Bracket (lower) complete for 7-14, 7-20 and 7-35 Machines, Nos. 19546, 19547 and two 190e.....

NO.	PLATE	NAME
19726	—	Feed (upper) Bar Guide Bracket (lower) complete for 7-30 Machine, Nos. 19546, 19547 and two 190E.....
19727	922	Needle Bar for 19731, obsolete.....
19728	923	" Clamp for 19730, obsolete.....
19729	923	" " Body for 19730, obsolete..
19730	923	Needle Clamp (adjustable) complete for 19731, Nos. 172F, 1140F, 19728 and 19729, obsolete.....
19731	—	Needle Bar complete, for No. 7 One-Needle Machines, Nos. 2269, 19727 and 19730, obsolete.....
19732	911	Needle Bar for 19735.....
19733	914	" Clamp (left) with 191F, for 19735
19734	914	" " (right) with 191F, for 19735
19735	—	Needle Bar complete, with adjustable clamps complete, for 7-22, 7-26, 7-37, 7-42, 7-44, 7-45, 7-50 to 7-52 Machines, and for 1 in. to 1½ in. gauges for 7-43 and 7-54 Machines, Nos. 19732 to 19734 and two 898E.....
19737	924	Presser Foot for 7-11 and 7-46 Machines..
19738	—	Throat Plate Body for 19740.....
19739	924	" " Needle Hole Strip for 19740
19740	924	Throat Plate complete for 19791, for 7-11 and 7-46 Machines, Nos. 19738, 19739 and two 401D.....
19741	—	Throat Plate Body for 19743 and 19745..
19742	925	" " Needle Hole Strip with ridge, for 19743.....
19743	925	Throat Plate complete for 19791, for 7-11 and 7-46 Machines, Nos. 19741, 19742 and two 401D.....
19744	4400	Throat Plate Needle Hole Strip for 19745
19745	4400	Throat Plate complete for 19791, for 7-13 and 7-15 Machines, Nos. 19741, 19744 and two 401D.....
19746	4400	Vibrating Presser Foot for 7-13 and 7-15 Machines.....
19747	4430	Arm Shaft for 7-26 and 7-50 Machines....
19749	922	Vibrating Presser Bar for 19750.....
19750	922	Vibrating Presser Bar complete for 7-13 and 7-15 Machines, Nos. 11739, 19749 and two 11740.....
19751	4401	Vibrating Presser Bar Guide Bracket Cap with 9042, for 19752.....

NO.	PLATE	NAME
19752	—	Vibrating Presser Bar Guide Bracket complete, for 7-13 and 7-15 Machines, Nos. 14593, 19751 and two 190E.....
19754	922	Thread Take-up Lever with 1948 and 1995, for 7-10 Machine, obsolete.....
*19755	—	Arm with 11559, 15404, 19888 and two each 128E, 612E and 15405, for No. 8, for 7-30 Machine, obsolete.....
*19756	—	Bed for 7-26, 7-37, 7-43, 7-50 to 7-52 and 7-54 Machines.....
19757	916	Cloth Plate for 7-26 and 7-37 Machines and for 1 in. to 1½ in. gauges, for 7-43 Machine.....
19758	4403	Crank Connecting Rod for 7-26, 7-37, 7-43, 7-50 to 7-52 and 7-54 Machines.....
19760	4404	Feed Bar for 7-26 and 7-37 Machines.....
19760	4404	" (lower) Bar for 1 in. and 1½ in. gauges, for 7-43 Machine.....
19761	9609	Feed Dog, 13 teeth (10 teeth to the inch) for 26789 and 58440, for 7-26 and 7-37 Machines.....
19761	9609	Feed (lower) Dog, 13 teeth (10 teeth to the inch) for 1 in. gauge, for 58440, for 7-43 Machine.....
19762	4403	Feed Forked Connection for 7-26, 7-37 and 7-50 to 7-52 Machines.....
19762	4403	Feed (lower) Forked Connection for 7-43 and 7-54 Machines.....
19765	4406	Feed Lifting Rock Shaft Crank with 135E and 1861, for 7-26 and 7-37 Machines, obsolete.....
19768	4404	Oscillating Rock Shaft for 19790, obsolete
19769	4402	" Shaft for 7-26, 7-37, 7-43, 7-50 to 7-52 and 7-54 Machines.....
19770	—	Oscillating Shaft Crank with 445c, for 19789.....
19771	4406	Oscillating Shaft Crank Slide Block for 19773.....
19772	4406	Oscillating Shaft Crank Slide Block Cap Screw Washer for 19773.....
19773	4406	Oscillating Shaft Crank Slide Block complete for 19789, Nos. 164E, 1156c, 19771 and 19772.....
19774	4404	Shuttle Driver with 445c, for 7-26, 7-37 and 7-50 to 7-52 Machines, and for 1 in. and 1½ in. gauges for 7-43 and 7-54 Machines.....

NO.	PLATE	NAME
19775	—	Shuttle Race Body for 19778.....
19776	4408	" " Ring (inside) for 19778....
19777	4408	" " " (outside) for 19778....
19778	4407	Shuttle Race complete for 7-26, 7-37 and 7-50 to 7-52 Machines, Nos. 19775 to 19777 and six 134E.....
19778	4407	Shuttle Race complete, for 1 in. and 1½ in. gauges, for 7-43 and 7-54 Machines, Nos. 19775 to 19777 and six 134E.....
19780	4404	Thread Take-up Lever with 1995, for 7-26, 7-37 and 7-39 Machines, obsolete.....
19784	4403	Vibrating Presser Bar for 7-26, 7-37 and 7-50 to 7-52 Machines.....
19785	914	Arm Dowel Pin for 7-26, 7-37, 7-43, 7-50 to 7-52 and 7-54 Machines.....
19786	4402	Arm Spool Bracket for 19788, obsolete....
19787	4403	" " " Spool Pin for 19788, obsolete.....
19788	4402	Arm Spool Bracket complete for 7-22 Machine, Nos. 19786 and two 19787, obsolete.....
19789	4406	Oscillating Shaft Crank complete for 7-26, 7-37, 7-43, 7-50 to 7-52 and 7-54 Machines, Nos. 1508J, 19770 and 19773
19790	—	Oscillating Rock Shaft complete for 7-26, 7-37, 7-43, 7-50 to 7-52 and 7-54 Machines, Nos. 654c, 9115, 11165, 19768 and two 1503J, obsolete.....
19791	924	Feed Dog, 17 teeth (11 teeth to the inch) for 19740, 19743 and 19745, for 7-11, 7-13, 7-15 and 7-46 Machines.....
19792	4401	Vibrating Presser Foot, for open back book work (corrugated backs) for 7-5 to 7-8 Machines.....
19793	914	Thread Take-up Spring Lever Stop Pin for 19691.....
19794	4427	Needle Bar for 7-30 Machine.....
19803	4428	Feed Dog, 15 teeth (10 teeth to the inch) for 19807 and 58292, for 7-16 to 7-18 Machines.....
19804	—	Throat Plate Body for 19807 and 58292
19805	—	" " Needle Plate (large oblong needle hole) for 58292.....
19806	4428	Throat Plate Needle Plate (small oblong needle hole) for 19807.....

NO.	PLATE	NAME
19807	4428	Throat Plate complete (small oblong needle hole) for 19803, for 7-16 to 7-18 Machines, Nos. 219F, 19804 and 19806
19808	856	Lifting Presser Bar Bell Crank for 19809.
19809	—	" " " " " 19808 with 611c and 19810, for 7-5 to 7-8, 7-13 and 7-15 to 7-18 Machines.....
19810	856	Lifting Presser Bar Bell Crank Adjusting Link with 1518J, 1828 and 2718, for 19809.....
19812	4421	Feed Lifting Rock Shaft Crank with 346E and 1861, for 19971.....
19812	4421	Feed (lower) Lifting Rock Shaft Crank with 346E and 1861, for 19971.....
19814	4421	Feed Lifting Rock Shaft Crank with 346E, 1518J and 1866, for 19969.....
19816	4439	Feed Lifting Rock Shaft Crank with 346E, 1513J and 1885, for 19972.....
19818	916	Feed Lifting Rock Shaft for 19820, obsolete.....
19819	4439	Feed Lifting Rock Shaft Crank with 346E and 1861, for 19820, 58347 and 58391.....
19819	4439	Feed (lower) Lifting Rock Shaft Crank with 346E and 1861, for 58347 and 58391.....
19820	—	Feed Lifting Rock Shaft complete for 7-26 and 7-37 Machines, Nos. 19818 and 19819, obsolete.....
19861	906	Driving Attachment Lever for 19862, obsolete.....
19862	—	Driving Attachment complete for 7-37 and 7-43 Machines, Nos. 1520J, 6055, 8873, 11440, 11864, 14785, 58286, 58289 and 126210, obsolete.....
19863	4454	Driving Attachment Lever Spring Hook (for machine flush with table) for 58379, 58380, 58443 and 58508 to 58510.....
19864	4402	Face Plate for 19865, obsolete.....
19865	—	Face Plate complete for 7-10 and 7-24 Machines, Nos. 190E, 910c, 11867, 11871 to 11873, 11875, 11876, 19864, 19866, 41544, 58581 or 58582 and two 164E, obsolete.....
19866	862	Lifting Presser Bar Lifter Hinge Pin for 19865, 58215 and 58217.....

NO.	PLATE	NAME
19868	878	Thread Take-up Lever with 1948 and 1995, for 7-16 to 7-18 and 7-30 Machines, obsolete.....
19869	4423	Shuttle Cylinder Latch Spring for 43264.....
19869	4423	Shuttle (inside) Cylinder Latch Spring for 43255.....
19869	4423	Shuttle (outside) Cylinder Latch Spring for 43256.....
19872	4424	Feed Dog, 15 teeth (10 teeth to the inch) for general work, for 19875, for 7-5 to 7-8 Machines.....
19873	—	Throat Plate Body for 19875.....
19874	4424	“ “ Needle Plate (oblong needle hole) for 19875.....
19875	4424	Throat Plate complete for 19872, for 7-5 to 7-8 Machines, Nos. 19873, 19874 and three 219F.....
19876	922	Lifting Presser Bar for 7-10, 7-22, 7-26, 7-36 and 7-37 Machines, obsolete.....
19877	890	Vibrating Presser Bar Spring Stud Pin for 11563.....
19878	4427	Presser Bar for 19879.....
19879	—	“ “ 19878 with 2049, 19882, 64052 and two 399E, for 7-14, 7-20 and 7-35 Machines.....
19880	4401	Presser Bar Clutch for 19881.....
19881	—	Presser Bar Clutch complete for 7-14, 7-20 and 7-35 Machines, Nos. 164E, 1916, 19880 and 41544.....
19882	4401	Presser Bar Rack for 19879.....
19883	4401	“ “ Spring (spiral) Collar for 7-14, 7-20 and 7-35 Machines.....
19884	4402	Face Plate for 19885, obsolete.....
19885	—	Face Plate complete for 7-22, 7-26, 7-36 and 7-37 Machines, Nos. 910c, 11867, 11875, 19583, 19590, 19701, 19866, 19884, 19886, 41544, 58579 or 58580 and three 164E, obsolete.....
19886	889	Thread Take-up Spring Thread Guard for 19885 and 58217.....
*19887	—	Arm Packing Plate for 7-26, 7-37, 7-43, 7-50 to 7-52 and 7-54 Machines.....
19888	858	Vibrating Presser Bar Cap Bracket (lower) for 19755 and 19963.....
19889	—	Tension (wheel) complete for 7-42, 7-43, 7-44, 7-45 and 7-54 Machines, Nos. 8787, 11241, 19684 to 19686, 58599 and two each 8879 and 58795.....

NO.	PLATE	NAME
19891	922	Feed (lower) Bar, for 1¼ in. to 1½ in. gauges, for 7-43 Machine.....
Nos. 19898 TO 19908 FOR 7-30 MACHINE		
*19898	—	Arm with 15404 and two 15405, for No. 8, obsolete.....
19899	4434	Feed (lower) Dog, 9 teeth (10 teeth to the inch) for 19908.....
19900	4434	Feed (lower) Dog (without teeth) for 19908.....
19901	4434	Lifting Presser Foot for 19899.....
19902	874	Needle Bar Connecting Stud with two 445E.....
19903	4435	Tension Bracket.....
19904	4435	Thread Take-up Spring Lever with 8077..
19905	4435	“ “ “ “ Collar.....
19906	4435	“ “ “ “ Regulator with 19614 and 58273.....
19907	4435	Thread Take-up Spring Staple.....
19908	4434	Throat Plate for 19899 and 19900.....
19909	4497	Cloth Plate for 7-32 Machine.....
19910	4445	Lifting Presser Bar Bracket with 145E and 647E, for 7-32, 7-42, 7-44 and 7-45 Machines.....
19911	4445	Lifting Presser Bar Lifting Link for 7-32, 7-42, 7-44 and 7-45 Machines.....
19912	4443	Lifting Presser Bar Sleeve (upper) for 19913.....
19913	—	Lifting Presser Bar Sleeve (upper) 19912 with 11492, for 7-32, 7-42, 7-44 and 7-45 Machines.....
Nos. 19914 TO 19919 FOR 7-32 MACHINE		
19914	4444	Lifting Presser Foot with 211F.....
19915	—	Throat Plate Body with 19620, for 19917.
19916	4444	“ “ Needle Hole Strip for 19917
19917	4444	Throat Plate complete for 9173, Nos. 19915, 19916 and two 401D.....
19918	4445	Vibrating Presser Bar.....
19919	4445	“ “ “ Cap Bracket with 11424.....
19920	4445	Vibrating Presser Bar Hinge Bracket with 145E, for 7-32, 7-42, 7-44 and 7-45 Machines.....
19921	4443	Vibrating Presser Bar Spring Stop for 7-32, 7-42, 7-44 and 7-45 Machines.....

NO.	PLATE	NAME
19922	4443	Vibrating Presser and Stretching Foot for 7-32 Machine.....
19923	9628	Arm Shaft for 7-52 Machine.....
*19924	—	Bed for 7-40, 7-53 and 7-55 Machines....
19926	4446	Buff Wheel Clamp Carrier for 58396 to 58398 and 58536 to 58538.....
19927	4446	Buff Wheel Clamp Carrier Cap for 58396 to 58398.....
19928	—	Buff Wheel Clamp Carrier Driving Gear (large) for 19929, 19930 and 58325.....
19929	4447	Buff Wheel Clamp Carrier Driving Gear (large) 19928 with 19931, for ¼ in. space between rows of stitching, for 58398 and 58538.....
19930	4447	Buff Wheel Clamp Carrier Driving Gear (large) 19928 with 19932, for ⅜ in. space between rows of stitching, for 58396 and 58536.....
19931	—	Buff Wheel Clamp Carrier Driving Gear (small) for 19929.....
19932	—	Buff Wheel Clamp Carrier Driving Gear (small) for 19930.....
19933	—	Buff Wheel Clamp Carrier Driving Gear (intermediate) large, for 19934.....
19934	4447	Buff Wheel Clamp Carrier Driving Gear (intermediate) large, 19933 with 19935, for 58396 to 58398 and 58536 to 58538
19935	—	Buff Wheel Clamp Carrier Driving Gear (intermediate) small, for 19934.....
19936	4446	Buff Wheel Clamp Carrier Driving Gear Plate for 58396 to 58398 and 58536 to 58538.....
19937	4448	Buff Wheel Clamp Carrier Driving Gear Plate Flanged Bushing for 58396 to 58398 and 58536 to 58538.....
19938	4448	Buff Wheel Clamp Carrier Driving Gear Disengaging Lever for 19939.....
19939	—	Buff Wheel Clamp Carrier Driving Gear Disengaging Lever 19938 with 2049 and 19940, for 58396 to 58398 and 58536 to 58538.....
19940	4448	Buff Wheel Clamp Carrier Driving Gear Disengaging Lever Shaft for 19939....
19941	4446	Buff Wheel Clamp Carrier Rack for 7-40 Machine, obsolete.....
19942	4448	Buff Wheel Clamp Carrier Spindle for 19943 and 58530.....

NO.	PLATE	NAME
19943	—	Buff Wheel Clamp Carrier Spindle 19942 with 9170 and three 401D, for 58396 to 58398.....
19944	4447	Buff Wheel Clamp Carrier Spindle Gear with 462c, for 58396 to 58398 and 58536 to 58538.....
19945	4446	Buff Wheel Clamp Carrier Stop Plate for 7-40, 7-53 and 7-55 Machines.....
19946	4446	Feed Bar for 7-40, 7-53 and 7-55 Machines
19950	4443	Lifting Presser Bar Sleeve (intermediate) for 7-40, 7-53 and 7-55 Machines.....
19951	860	Lifting Presser Foot with 211F, for 7-40 and 7-53 Machines.....
19952	4450	Shuttle Race Frame with 11838, for 7-40, 7-53 and 7-55 Machines.....
19953	4450	Shuttle Race Slide for 7-40, 7-53 and 7-55 Machines.....
19957	4446	Vibrating Presser Bar for 7-40, 7-53 and 7-55 Machines.....
19958	9617	Vibrating Presser Foot for 7-40 and 7-53 Machines.....
*19959	—	Arm with 15404 and two 15405, for 7-1 to 7-8, 7-13, 7-15 to 7-18 and 7-29 Machines.....
*19960	—	Arm with 11559, 11560, 15404 and two each 128E, 612E and 15405, for 7-10 Machine, obsolete.....
*19961	—	Arm with 15404 and two 15405, for 7-14, 7-20 and 7-35 Machines.....
*19962	—	Arm with 11559, 11560, 15404 and two each 128E, 612E and 15405, for 7-22 and 7-36 Machines.....
*19963	—	Arm with 11559, 15404, 19888 and two each 128E, 612E and 15405, for 7-26, 7-37 and 7-50 to 7-52 Machines.....
*19965	—	Arm with 15404 and two 15405, for 7-30 Machine.....
19967	861	Feed Lifting Rock Shaft Wearing Block for 19968, 19970, 58346 and 58390....
19967	861	Feed (lower) Lifting Rock Shaft Wearing Block for 19970, 58346 and 58390....
19968	4420	Feed Lifting Rock Shaft with 134E, 2022 and 19967, for 19969.....
19969	—	Feed Lifting Rock Shaft complete for 7-11, 7-13, 7-15 and 7-46 Machines, Nos. 19814 and 19968.....

NO.	PLATE	NAME
19970	4420	Feed Lifting Rock Shaft with 134E, 2022 and 19967, for 19971 and 19972.....
19970	4420	Feed (lower) Lifting Rock Shaft with 134E, 2022 and 19967, for 19971.....
19971	—	Feed Lifting Rock Shaft complete for 7-1 to 7-8, 7-10, 7-16 to 7-18, 7-22, 7-29, 7-36, 7-40, 7-42, 7-44, 7-45, 7-47, 7-53 and 7-55 Machines, Nos. 19812 and 19970.....
19971	—	Feed (lower) Lifting Rock Shaft complete for 7-30 Machine, Nos. 19812 and 19970
19972	—	Feed Lifting Rock Shaft complete for 7-24 and 7-32 Machines, Nos. 19816 and 19970.....
19977	7268	Shuttle Cylinder for 58213 and 58404.....
19979	7268	" Tension Spring for 58213.....
19981	—	Needle Bar Connecting Stud 11383 with 11539, for 7-1 to 7-8, 7-11, 7-13 to 7-18, 7-20, 7-24, 7-29, 7-32, 7-35, 7-40, 7-46, 7-53 and 7-55 Machines.....
*19986	—	Shuttle Cylinder 11852 with 773r and 8964, for 19636.....
19991	4496	Balance Wheel and Pulley (tight) with two 354c, for 19994, for 7-26 and 7-50 Machines.....
19992	—	Belt Shifter Guide Rod for 19994.....
19993	—	" " Pulley (loose) for 19994.....
19994	—	Belt Shifter complete for 7-26 and 7-50 Machines, Nos. 10b, 2117, 3012, 4885, 6439, 9137, 11446, 11451, 11453, 11454, 11459, 11940, 11941 and 19991 to 19993
19997	—	Throat Plate Needle Hole Strip (left) for 19593.....
21875	4457	Wrench for 1646 (Accessories).....
21876	4457	" " 496 (Accessories).....
23258	9621	Driving Attachment Treadle Bracket (left) Hook Friction Washer for 126206.....
23535	4484	Wrench for 346, 1528, 1547 and 1549 (Accessories).....
24131	9608	Bed Oil Tube with 52045, for oiling Feed Rock Shaft (back) Bearing.....
25028	889	Bobbin Winder Belt Hook for 11756 and 11768.....
25200	9623	Wrench for 354 and 909.....
25362	9621	Balance Wheel Ball, size $\frac{1}{8}$ in., for 122304
25362	9621	Driving Attachment Balance Wheel Ball, size $\frac{1}{8}$ in., for 122304.....

NO.	PLATE	NAME
25837	904	Presser Foot Spring for 19708.....
25837	904	Vibrating Presser and Stretching Foot Spring for 7-24 and 7-32 Machines.....
25881	894	Guide (6 in. face) for 7-1 to 7-8, 7-10, 7-14, 7-16 to 7-18, 7-20, 7-30, 7-35 and 7-47 Machines.....
26026	4484	Screw Driver (small) Accessories.....
26159	894	Guide (10 in. face) for 7-11, 7-13, 7-15 and 7-46 Machines.....
26176	847	Guide (6 in. face) for 7-26, 7-37, 7-50 to 7-52 and 7-54 Machines.....
26419	4417	Guide (6 in. face) for 7-22, 7-36 and 7-42 to 7-45 Machines.....
26509	4413	Vibrating Presser Foot for 26799, for 7-5 to 7-8 Machines.....
26510	9617	Vibrating Presser Foot, for side stitching, for 14592, for 7-5 to 7-8 Machines.....
26786	4409	Strip Folder on Shank, for folding strips for coal bag handles, for 7-7 Machine..
26787	4409	Hemmer on Shank, for canvas coal bags, for 7-7 Machine.....
26788	4409	Strip Folder on Shank, for folding strips for coal bag handles, for 7-22 and 7-36 Machines.....
26789	4410	Lap Seam Feller on Shank for 7-22, 7-26, 7-36 and 7-37 Machines.....
26793	4410	Binder on Shank, for woven strip, for 7-5 to 7-8 Machines.....
26794	4412	Lap Seam Feller (left hand) on Shank, to fold top only, for 7-1 to 7-8 Machines..
Nos. 26795 to 26797, FOR 26799		
26795	4413	Corder Cord Guide.....
26796	4413	" " " Arm with 26798 and three 6037.....
26797	4413	Corder Cord Guide Bed.....
26798	4413	" " " Bracket for 26796...
26799	4413	Corder (adjustable) complete, for buggy cushions, Nos. 190E, 1044b and 26795 to 26797.....
27306	7833	Thread Unwinder Spool Pin for 27778....
27555	7285	Bobbin Winder Thread Unwinder Spool Pin for 27556 and 41451.....
27555	7285	Thread Unwinder Spool Pin for 27556...
27556	—	Bobbin Winder Thread Unwinder Spool Rest 27583 with 138E and two 27555, for 41823.....

276 NUMERICAL LIST OF PARTS

NO.	PLATE	NAME
27556	—	Thread Unwinder Spool Rest 27583 with 138E and two 27555, for 60637.....
27557	3582	Bobbin Winder Thread Unwinder Spool Stand with 138E, for 41454 and 41823..
27557	7833	Thread Unwinder Spool Stand with 138E, for 60612 and 60613.....
27560	3582	Bobbin Winder Thread Unwinder Thread Guard Rod, 26 inches long, for 41454 and 41823.....
27560	7833	Thread Unwinder Thread Guard Rod, 26 in. long, for 60612.....
27583	7285	Bobbin Winder Thread Unwinder Spool Rest for 27556.....
27583	7285	Thread Unwinder Spool Rest for 27556...
27637	9629	Driving Attachment Treadle Pitman Rod (lower) for 27640, obsolete.....
27639	9629	Driving Attachment Treadle Pitman Rod for 60626.....
27639	9629	Driving Attachment Treadle Pitman Rod (upper) for 27640, obsolete.....
27640	9629	Driving Attachment Treadle Pitman complete for 126210, Nos. 2762, 6055, 27637, 27639, 150208 and two 9079, obsolete
27693	7833	Thread Unwinder Thread Guard Rod, 37 in. long, for 60613 and 60637.....
27777	7833	Thread Unwinder Spool Rest for 27778...
27778	—	" " " 27777 with 168A and three 27306, for 60612 and 60613.....
27916	3583	Bobbin Winder Brake (leather) for 41439 and 41550.....
28084	3583	Bobbin Winder Brake Rivet for 41439 and 41550.....
28997	4414	Binder on Shank, to fold top edge only, for carpets, for 7-6 Machine.....
36181	4410	Binder on Shank, to turn in both edges of binding, for binding carpets, for 7-5 to 7-8 Machines.....
36577	4417	Guide (6 in. face) for 7-29 Machine.....
40025	4492	Oscillating Shaft Crank Pin for 7-1 to 7-8, 7-10, 7-11, 7-13 to 7-18, 7-20, 7-22, 7-24, 7-29, 7-30, 7-32, 7-35, 7-36, 7-40, 7-42, 7-44 to 7-47, 7-53 and 7-55 Machines.....
41124	4480	Bridle Iron with four each 41125 and 51080E, to set machine flush with table

NUMERICAL LIST OF PARTS 277

NO.	PLATE	NAME
41125	9621	Bridle Iron Bolt Washer for 41124.....
41398	3583	Bobbin Winder Bobbin Carrier Key for 41444.....
41439	3579	Bobbin Winder Base with 458c, 27916 and two 28084, for 41558.....
41440	3581	Bobbin Winder Frame for 41555 and 41558.....
41441	3581	Bobbin Winder Frame Hinge Pin for 41555, 41558, 41900 and 60217.....
41442	3581	Bobbin Winder Frame Spring for 41555 and 41558.....
41443	3581	Bobbin Winder Pulley with 155c, for 41555 and 41558.....
41444	3579	Bobbin Winder Spindle with 41398, for 41558.....
41446	6781	Bobbin Winder Stop Latch Hinge Pin for 60630.....
41447	3581	Bobbin Winder Tripping Arm with 176E, for 41555 and 41558.....
41450	3582	Bobbin Winder Thread Unwinder Spool Rest for 41451.....
41451	—	Bobbin Winder Thread Unwinder Spool Rest 41450 with 138E and 27555, for 41454.....
41454	3582	Bobbin Winder Thread Unwinder complete, for one large spool, for 41556 and 41559, Nos. 27557, 27560, 41451, 41514, 60609 and three wood screws 1¼ in. No. 12.....
41514	3582	Bobbin Winder Thread Unwinder Spool Weight, 4 in. diam., with 41515, for 41454.....
41515	3583	Bobbin Winder Thread Unwinder Spool Weight Center Pin for 41514.....
41544	4415	Binder Screw Washer for 11576.....
41544	4415	Bobbin Winder Screw Washer for 11752, obsolete.....
41544	4415	Guide Screw Washer for 7-10 and 7-47 Machines.....
41544	4415	Guide Thumb Screw Washer for 7-10 Machine, obsolete.....
41544	4415	Feed Reverse Lever Stop Washer for 7-11 and 7-46 Machines.....
41544	4415	Lap Seam Feller Screw Washer for 26789 and 26794.....

NO.	PLATE	NAME
41544	4415	Presser Bar Clutch Roller Cap Screw Washer for 11055 and 19881.....
41544	4415	Presser Bar Hinge Cap Screw Washer for 7-11 and 7-46 Machines.....
41544	4415	Tension Thread Guard Screw Washer for 7-42 to 7-45 and 7-54 Machines.....
41544	4415	Thread Take-up Spring Lever Regulator Screw Washer for 7-43 and 7-54 Machines.....
41544	4415	Thread Take-up Spring Screw Washer for 19596, 19865, 19885, 58215 and 58217..
41544	4415	Thread Take-up Spring Staple Screw Washer for 7-14, 7-20, 7-30 and 7-35 Machines.....
41544	4415	Vibrating Presser Bar Hinge Cap Screw Washer for 7-40, 7-53 and 7-55 Machines, and obsolete for 7-5 to 7-8 and 7-15 to 7-18 Machines.....
41550	3580	Bobbin Winder Base with 458c, 27916 and two 28084, for 41555.....
41551	3583	Bobbin Winder Bobbin Position Pin for 41553.....
41552	3580	Bobbin Winder Spindle for 41555.....
41553	3583	“ “ Collar with 41551 and two 449c, for 41555.....
41554	3580	Bobbin Winder Stop Latch for 41555.....
41555	3580	“ “ for 41556, Nos. 2269, 11107, 41440 to 41443, 41447, 41550, 41552 to 41554, two 4784 and three wood screws 1 in. No. 7.....
41556	—	Bobbin Winder (swinging automatic, right hand) complete, for flat or round belt, for 16901, Nos. 41454 and 41555.....
41557	6781	Bobbin Winder Stop Latch for 60630.....
41558	3579	“ “ for 41559 and 41824, Nos. 41439 to 41444, 41447, 60630, two 4784 and three wood screws 1 in. No. 7.....
41559	—	Bobbin Winder (swinging automatic, right hand) complete, for flat or round belt, for 11910, Nos. 41454 and 41558.....
41823	7285	Bobbin Winder Thread Unwinder complete, for two large spools, for 41824, 60219, 60260, 60272, 60273, 60275 and 60277 to 60279, Nos. 27556, 27557, 27560, 60609 and three wood screws 1¼ in. No. 12.....

NO.	PLATE	NAME
41824	—	Bobbin Winder (swinging automatic, right hand) complete, for flat or round belt, for 11910, Nos. 41558 and 41823.....
41894	4485	Bobbin Winder Base with 449c, for 41900 and 60217.....
41895	4492	Bobbin Winder Bobbin Carrier Key for 41898.....
41896	4485	Bobbin Winder Frame for 41900 and 60217.....
41897	4485	Bobbin Winder Frame Spring for 41900 and 60217.....
41898	6781	Bobbin Winder Spindle with 41895, for 41900.....
41899	4486	Bobbin Winder Tripping Arm with 176e, for 41900 and 60217.....
41900	6781	Bobbin Winder for 60260, 60272, 60275 and 60277, Nos. 41441, 41894, 41896 to 41899, 43270, 60630 and two 4784.....
43235	7818	Shuttle Cylinder Latch for 43264.....
43235	7818	“ (outside) Cylinder Latch for 43256.....
43236	7816	Shuttle Cylinder Latch Hinge Pin for 43264.....
43236	7816	Shuttle (inside) Cylinder Latch Hinge Pin for 43255.....
43236	7816	Shuttle (outside) Cylinder Latch Hinge Pin for 43256.....
43239	7816	Shuttle (inside) Cylinder Latch for 43255.....
43240	7817	“ “ Frame for 43255.....
43242	7819	“ (outside) Frame for 43256.....
43249	—	“ “ 8779 with 330b and 8778, for 58360.....
43250	—	Shuttle (inside) Frame 8894 with 330b and 8893, for 58358.....
43255	—	Shuttle (inside) Frame 43240 with 19869, 43236 and 43239, for 43275.....
43256	—	Shuttle (outside) Frame 43242 with 19869, 43235 and 43236, for 43283.....
43260	7823	Shuttle Frame for 43264.....
43263	4492	Arm Screw Washer for 7-26, 7-37, 7-43, 7-50 to 7-52 and 7-54 Machines.....
43264	—	Shuttle Frame 43260 with 19869, 43235 and 43236, for 43285.....
43267	4492	Lifting Presser Bar Lifting Link Hinge Stud Washer for 7-5 to 7-8, 7-11, 7-13, 7-15 to 7-18, 7-30, 7-32, 7-40, 7-42, 7-46 and 7-53 to 7-55 Machines.....

NO.	PLATE	NAME
43267	4492	Presser Bar Lifting Link Hinge Stud Washer for 11407, for 7-1 to 7-4, 7-14, 7-20, 7-29 and 7-35 Machines.....
43270	4486	Bobbin Winder Friction Pulley with 43271, two 448c and ten 15405, for 41900 and 60217.....
43271	4486	Bobbin Winder Friction Pulley Ring (leather) for 43270.....
43273	7816	Shuttle Bobbin Center Pin for 43284.....
43273	7816	" (inside) Bobbin Center Pin for 43274.....
43273	7816	Shuttle (outside) Bobbin Center Pin for 43282.....
43274	7817	Shuttle (inside) Cylinder with 43273, for 43286.....
43275	7816	Shuttle (inside) Cylinder, 4 in. diam., complete for 7-26, 7-37, 7-50 to 7-52 Machines, and for 1 in. and 1½ in. gauges for 7-43 and 7-54 Machines, Nos. 8777, 16901, 43255 and 43286.....
43282	7818	Shuttle (outside) Cylinder with 43273, for 43287.....
43283	7818	Shuttle (outside, cylinder) 4 in. diam., complete for 7-26, 7-37, 7-50 to 7-52 Machines, and for 1 in. and 1½ in. gauges for 7-43 and 7-54 Machines, Nos. 8777, 16901, 43256 and 43287.....
43284	7822	Shuttle Cylinder with 43273, for 43288..
43285	7822	Shuttle (cylinder) 4 in. diam., complete for 7-29 Machine, Nos. 8777, 16901, 43264 and 43288.....
43286	—	Shuttle (inside) Cylinder 43274 with 1323F and 8895, for 43275.....
43287	—	Shuttle (outside) Cylinder 43282 with 1323F and 8900, for 43283.....
43288	—	Shuttle Cylinder 43284 with 1323F and 58209, for 43285.....
46681	9623	Driving Attachment Treadle Bracket (right) for 60502.....
*49191	—	Oscillating Rock Shaft Oil Tube Sleeve for 58553.....
50027D	4494	Hemmer Screw for 120147.....
50124D	4494	Bobbin Winder Bracket Screw for 60219, 60260, 60272, 60273, 60275, 60277 to 60279.....
50124E	4494	Feed Rock Shaft Crank Set Screw for 58447.....

NO.	PLATE	NAME
50166E	4499	Thread Take-up Spring Eyelet for 58281..
50201F	4453	Buff Wheel Thumb Screw for 7-24, 7-32, 7-40, 7-53 and 7-55 Machines.....
50204D	4451	Buff Wheel Clamp Carrier Driving Gear Screw for 58396 to 58398 and 58536 to 58538.....
50205D	4451	Buff Wheel Clamp Carrier Driving Gear (intermediate) Screw for 58396 to 58398 and 58536 to 58538.....
50322D	4489	Feed Regulator Thumb Screw for 7-1 to 7-8, 7-10, 7-11, 7-13, 7-15 to 7-18, 7-22, 7-24, 7-26, 7-29, 7-32, 7-36, 7-37, 740, 7-42 to 7-47, 7-50 to 7-52 and 7-55 Machines.....
50322D	4489	Feed (lower) Regulator Thumb Screw for 7-30, 7-43 and 7-54 Machines.....
50323D	4489	Lifting Presser Bar Spring Regulating Thumb Screw for 7-10, 7-22, 7-26, 7-30, 7-32, 7-36, 7-37, 7-40, 7-42 to 7-45, 7-47, 7-50 to 7-55 Machines.....
50323D	4489	Presser Bar Spring Regulating Thumb Screw for 7-14, 7-20, 7-22, 7-35 and 7-36 Machines.....
50343E	4494	Needle Bar Screw Bushing (lower) for 7-42, 7-44 and 7-45 Machines.....
50347E	4489	Arm Screw for 7-26, 7-37, 7-43 and 7-50 to 7-52 and 7-54 Machines.....
50348E	9619	Arm Screw for 7-1 to 7-8, 7-10, 7-11, 7-13, 7-14 to 7-18, 7-20, 7-22, 7-24, 7-29, 7-30, 7-32, 7-35, 7-36, 7-40, 7-42, 7-44 to 7-47, 7-53 and 7-55 Machines.....
50437D	4494	Thread Take-up Lever Hinge Screw for 58312, 58314 to 58316, 58320 and 58337
50581R	9620	Driving Attachment Treadle Extension Screw for 126037.....
51062D	9620	Throat Plate Screw for 7-50 to 7-52 and 7-54 Machines.....
51080E	9619	Bridle Iron Bolt with 51578E, for 41124...
51227C	9619	Oscillating Rock Shaft Hinge Pin Screw Bearing for 58551.....
51237C	9619	Oscillating Rock Shaft Hinge Pin Screw Bearing for 58566 and 58572.....
51260D	9619	Lifting Presser Bar Bell Crank Hinge Screw for 7-5 to 7-8, 7-10, 7-13, 7-15 to 7-18, 7-22, 7-26, 7-30, 7-36, 7-37, 7-43, 7-47, 7-50 to 7-52 and 7-54 Machines...
51260D	9619	Presser Bar Lifting Bell Crank Hinge Screw for 7-14, 7-20 and 7-35 Machines.

NO.	PLATE	NAME
51578E	9620	Bridle Iron Bolt Nut for 51080E.....
51609E	9620	Lifting Presser Bar Bell Crank Hinge Screw Nut for 7-5 to 7-8, 7-10, 7-13, 7-15 to 7-18, 7-22, 7-26, 7-30, 7-36, 7-37, 7-43, 7-47, 7-50 to 7-52 and 7-54 Ma- chines.....
51609E	9620	Presser Bar Lifting Bell Crank Hinge Screw Nut for 7-14, 7-20 and 7-35 Machines.....
52045	9608	Bed Oil Tube Packing (felt) for 24131 and 58549.....
56814	—	Feed Bar Screw Center 307c with 1513j, for 7-1 to 7-8, 7-10, 7-11, 7-13, 7-15 to 7-18, 7-22, 7-24, 7-26, 7-29, 7-32, 7-36, 7-37, 7-40, 7-42, 7-44 to 7-47, 7-50 to 7-53 and 7-55 Machines.....
56814	—	Feed (lower) Bar Screw Center 307c with 1513j, for 7-30, 7-43 and 7-54 Machines
56864	9608	Belt Shifter Chain Hook (large) for 6439.
56864	9608	Chain Hook (large) for 13351.....
56865	9608	Belt Shifter Chain Hook (small) for 6439.
56865	9608	Chain Hook (small) for 13351.....
58203	—	Needle Bar Connecting Stud 19565 with 19564, for 7-22, 7-26, 7-36, 7-37, 7-42 to 7-45, 7-50 to 7-52 and 7-54 Machines
58209	7822	Shuttle Tension Spring for 43288.....
58213	—	" Cylinder 19977 with 773F and 19979, for 58525.....
58214	4495	Face Plate for 58215.....
58215	—	Face Plate complete for 7-10, 7-24 and 7-47 Machines, Nos. 190E, 910C, 11867, 11871, 11872, 11875, 11876, 19866, 41544, 58214, 58522, 58581 or 58582 and two 164E.....
58216	4497	Face Plate for 58217.....
58217	—	Face Plate complete for 7-22, 7-26, 7-36, 7-37 and 7-50 to 7-52 Machines, Nos. 910C, 11867, 11875, 19590, 19701, 19866, 19886, 41544, 58216, 58466, 58579 or 58580 and three 164E.....
58218	4497	Cloth Plate with 58219, 58220 and four 58221, for 7-22, 7-36, 7-42, 7-44 and 7-45 Machines.....
*58219	—	Cloth Plate Packing (back) for 58218....
*58220	—	" " " (front) for 58218....
58221	4492	" " " Rivet for 58218.....
58229	—	Spool Holder Bracket for 58230.....

NO.	PLATE	NAME
58230	—	Spool Holder Bracket complete for 7-10 Machines, Nos. 11881 and 58229, ob- solete.....
58232	4491	Feed Regulator Thumb Screw Stop for 7-10 and 7-47 Machines.....
58233	4490	Feed Rock Shaft for 58234.....
58233	4490	" (lower) Rock Shaft for 58234.....
58234	—	Feed Rock Shaft complete for 7-1 to 7-8, 7-10, 7-16 to 7-18, 7-22, 7-24, 7-29, 7-32, 7-36, 7-40, 7-42, 7-44, 7-45, 7-47, 7-53 and 7-55 Machines, Nos. 58233 and 58235.....
58234	—	Feed (lower) Rock Shaft complete for 7-30 and 7-43 Machines, Nos. 58233 and 58235.....
58235	4491	Feed Rock Shaft Crank with 346M, for 58234, 58322 and 58393.....
58235	4491	Feed (lower) Rock Shaft Crank with 346E, for 58234 and 58393.....
58236	4493	Lifting Presser Bar for 7-10, 7-22, 7-26, 7-36, 7-37, 7-47 and 7-50 to 7-52 Ma- chines.....
58237	4491	Lifting Presser Bar Lifter Bracket with 1497F and 58238, for 7-10, 7-22, 7-26, 7-36, 7-37, 7-47 and 7-50 to 7-52 Ma- chines.....
58238	4491	Lifting Presser Bar Lifter Bracket Spring Bearing for 58237.....
58239	4491	Vibrating Presser Bar Guide Bracket with 874E and 1497F, for 7-10, 7-22, 7-26, 7-36, 7-37, 7-47 and 7-50 to 7-52 Machines.....
58240	4491	Vibrating Presser Bar Stop Block for 7-10, 7-22, 7-26, 7-36, 7-37, 7-47 and 7-50 to 7-52 Machines.....
58241	—	Throat Plate complete for 11369, for 7-1 to 7-8, 7-10 and 7-47 Machines, Nos. 219F, 11432 and 11435.....
58242	4491	Needle Bar Connecting Stud with two 129E, for 58246.....
58246	—	Needle Bar Connecting Stud 58242 with 11539, for 7-10 and 7-47 Machines.....
58247	4480	Balance Wheel with two 354c, for 58289, obsolete.....
58248	4480	Driving Attachment Lever for 58286 and 58441, obsolete.....

284 NUMERICAL LIST OF PARTS

NO.	PLATE	NAME
58249	4496	Balance Wheel (two speed) with two 354c, for 7-42 Machine, obsolete.....
*58250	—	Arm with 11559, 11560, 15404 and two each 128E, 612E and 15405, for 7-10 and 7-47 Machines.....
58252	4493	Lifting Presser Bar Spring Bracket for 7-10, 7-22, 7-26, 7-30, 7-32, 7-36, 7-37, 7-40, 7-42 to 7-45, 7-47, 7-50 to 7-55 Machines.....
58252	4493	Presser Bar Spring Bracket for 7-14, 7-20 and 7-35 Machines.....
58253	—	Oil Cup for 58254.....
58254	4490	Oil Cup complete, for all machines except 7-24, Nos. 2205, 8482, 9084, 11917, 11918, 58253, two 8953 and three 207F.....
58255	4493	Spool Holder Bracket for 58256.....
58256	4493	Spool Holder Bracket complete for 7-10 and 7-47 Machines, Nos. 11881 and 58255.....
58263	7831	Table Belt Guide Bracket with 448c, for 58268.....
58264	7831	Table Belt Guide Pulley for 58268.....
58265	7831	" " " " Shaft with 58266 and 58267, for 58268.....
58266	4492	Table Belt Guide Pulley Shaft Oil Hole Plug for 58265.....
58267	—	Table Belt Guide Pulley Shaft Packing (wick) for 58265.....
58268	—	Table Belt Guide complete, for flat belt, for power table, Nos. 58264, 58265, two 58263 and eight wood screws 1½ in. No. 14 R. H. M. F. O. and A.....
58270	4491	Lifting Presser Bar Guide with 453c and 896E, for 7-10 and 7-47 Machines.....
58273	4492	Thread Take-up Spring Lever Stop Pin for 19906.....
*58274	—	Arm with 15404 and two 15405, for 7-42 Machine, obsolete.....
58275	7815	Lifting Presser Bar Rock Shaft Bracket for 7-42, 7-44 and 7-45 Machines.....
58276	7821	Lifting Presser Foot with 168E, for 7-42, 7-44 and 7-45 Machines.....
58277	4492	Shuttle Driver Pin for 7-42, 7-44 and 7-45 Machines.....
58277	4492	Shuttle Race Dowel Pin for 7-22, 7-26, 7-36, 7-37, 7-42 to 7-45, 7-50 to 7-52 and 7-54 Machines.....

NUMERICAL LIST OF PARTS 285

NO.	PLATE	NAME
Nos. 58278 TO 58283 FOR 7-42, 7-44 AND 7-45 MACHINES		
58278	7815	Tension Bracket and Vibrating Presser Bar Cap.....
58279	4499	Tension Thread Guard.....
58280	4499	Thread Take-up Spring Bracket.....
58281	4499	" " " Lever with 50166E.....
58282	7815	Vibrating Presser Bar.....
58283	7821	" " Foot.....
*58285	—	Arm with 15404 and two 15405, for 7-42, 7-44 and 7-45 Machines.....
58286	—	Driving Attachment Lever 58248 with 9D, 134E, 8984, 8991, 8992, 19663 and two 497E, for 19862 and 58380, obsolete.....
58289	—	Balance Wheel 58247 with 11442 and four 401E, for 19862, obsolete.....
58290	—	Balance Wheel 11438 with 11442 and four 401E, for 19664, obsolete.....
58292	—	Throat Plate complete (large, oblong needle hole) for 19803, for 7-16 to 7-18, Machines, 219E, 19804 and 19805.....
58293	—	Oscillating Rock Shaft Hinge Pin 11398 with 1508J, for 11397 and 11842, obsolete.....
58294	—	Shuttle Frame 19637 with 590D, 11853, 11854 and 12002, for 19636.....
58295	—	Thread Take-up Lever for 58296.....
58296	4493	" " " 58295 with 1995, for 58320.....
58297	—	Thread Take-up Lever for 58298.....
58298	4493	" " " 58297 with 1948 and 1995, for 58314.....
58299	—	Thread Take-up Lever for 58300.....
58300	4493	" " " 58299 with 1948 and 1995, for 58315.....
58301	—	Thread Take-up Lever for 58302.....
58302	7815	" " " 58301 with 1995, for 58316.....
58303	—	Thread Take-up Lever with two 9219, for 58304.....
58304	7815	Thread Take-up Lever 58303 with 1995, for 58312.....
58305	—	Thread Take-up Lever for 58306.....
58306	7815	" " " 58305 with 1995, for 58337.....
58310	4490	Lifting Lever for 19521.....

NO.	PLATE	NAME
58311	4490	Lifting Lever for 19648.....
58312	—	Thread Take-up Lever 58304 with 50437D, for 7-26, 7-37, 7-43, 7-50 to 7-52 and 7-54 Machines.....
58314	—	Thread Take-up Lever 58298 with 50437D, for 7-10 and 7-47 Machines..
58315	—	Thread Take-up Lever 58300 with 50437D, for 7-16 to 7-18 and 7-30 Machines....
58316	—	Thread Take-up Lever 58302 with 50437D, for 7-22, 7-36, 7-42, 7-44 and 7-45 Ma- chines.....
58317	—	Tension (wheel) complete for 7-16 to 7-18 and 7-29 Machines, Nos. 8791, 8905, 11044, 11423, 58589 and two 8879.....
58319	4492	Thread Take-up Cam Washer for 7-22, 7-26, 7-36, 7-37 and 7-50 to 7-52 Ma- chines.....
58320	—	Thread Take-up Lever 58296 with 50437D, for 7-1 to 7-8, 7-11, 7-13 to 7-15, 7-20, 7-24, 7-32, 7-35, 7-40, 7-46, 7-53 and 7-55 Machines.....
58321	4490	Feed Rock Shaft for 58322.....
58322	—	Feed Rock Shaft complete for 7-26 and 7-37 Machines, Nos. 58235 and 58321..
58325	4499	Buff Wheel Clamp Carrier Driving Gear (large) 19928 with 58326, for $\frac{1}{16}$ in. space between rows of stitching, for 58397 and 58537.....
58326	—	Buff Wheel Clamp Carrier Driving Gear (small) for 58325.....
58327	4493	Feed Bar for 7-22, 7-36, 7-42, 7-44 and 7-45 Machines.....
58328	4498	Feed Dog, 13 teeth (10 teeth to the inch) for 19593 and 26789, for 7-22, 7-36, 7-42, 7-44 and 7-45 Machines.....
58329	4495	Arm Shaft for 7-3, 7-7, 7-13, 7-14, 7-17, 7-20, 7-24, 7-29, 7-30, 7-44 and 7-53 Machines, and obsolete for 7-47 Ma- chine.....
58330	4495	Arm Shaft for 7-11 Machine.....
58334	—	" " " 7-43 Machine, obsolete....
58335	4496	Balance Wheel with two 354c, for 58336..
58335	4496	Driving Attachment Balance Wheel with two 354c, for 58336.....
58336	—	Balance Wheel 58335 with 11442, 122469, two 1402E and four 401E, for 7-37, 7-43, 7-51 and 7-54 Machines.....

NO.	PLATE	NAME
58336	—	Driving Attachment Balance Wheel 58335 with 11442, 122469, two 1402E and four 401E, for 58380, 58443, 58509 and 58510
58337	—	Thread Take-up Lever 58306 with 50437D, for 7-29 Machine.....
*58339	—	Arm with 15404 and two 15405, for 7-43 and 7-54 Machines.....
Nos. 58340 TO 58345 FOR 7-43 MACHINE		
58340	7835	Cloth Plate for $1\frac{1}{4}$ in. gauge.....
58341	7835	" " " $1\frac{3}{8}$ in. and $1\frac{1}{2}$ in. gauges,
58342	7836	Feed (lower) Dog, 13 teeth (10 teeth to the inch) for $1\frac{1}{8}$ in. gauge, for 58369...
58343	7838	Feed (lower) Dog, 13 teeth (10 teeth to the inch) for $1\frac{1}{4}$ in. gauge, for 58371...
58344	7839	Feed (lower) Dog, 13 teeth (10 teeth to the inch) for $1\frac{3}{8}$ in. gauge, for 58375...
58345	7840	Feed (lower) Dog, 16 teeth (10 teeth to the inch) for $1\frac{1}{2}$ in. gauge, for 58377...
58346	7835	Feed Lifting Rock Shaft with 134E, 2022 and 19967, for 58347.....
58346	7835	Feed (lower) Lifting Rock Shaft with 134E 2022 and 19967, for 58347.....
58347	—	Feed Lifting Rock Shaft complete for 7-26 and 7-37 Machines, Nos. 19819 and 58346.....
58347	—	Feed (lower) Lifting Rock Shaft complete for 7-43 Machine, Nos. 19819 and 58346
58348	7841	Feed (upper) Bar Guide Bracket (lower) with 456c, for 58349.....
58349	—	Feed (upper) Bar Guide Bracket (lower) complete, for $1\frac{1}{4}$ in. to $1\frac{1}{2}$ in. gauges, for 7-43 and 7-54 Machines, Nos. 58348, 58350 and two 190E.....
58350	7841	Feed (upper) Bar Guide Bracket (lower) Cap for 58349.....
58351	7842	Feed (upper) Bar Guide Bracket (upper) with 11424, for $1\frac{1}{4}$ in. to $1\frac{1}{2}$ in. gauges, for 7-43 and 7-54 Machines.....
58352	7836	Feeding Foot for 7-43 and 7-54 Machines
58353	7842	Needle Bar for 58354.....
58354	—	Needle Bar complete with adjustable clamp, for $1\frac{1}{4}$ in. to $1\frac{1}{2}$ in. gauges, for 7-43 and 7-54 Machines, Nos. 58353, 58355, 58356 and two 898E.....
58355	7841	Needle Clamp (left) with 191F, for 58354
58356	7841	" " (right) with 191F, for 58354

NO.	PLATE	NAME
58357	7843	Shuttle (inside) Cylinder for 58405.....
58358	7843	Shuttle (inside, cylinder) 4 in. diam., complete, for 1¼ in. to 1½ in. gauges, for 7-43 and 7-54 Machines, Nos. 8777, 16901, 43250 and 58405.....
58359	7844	Shuttle (outside) Cylinder for 58403.....
58360	7844	Shuttle (outside, cylinder) 4 in. diam., complete, for 1¼ in. to 1½ in. gauges, for 7-43 and 7-54 Machines, Nos. 8777, 16901, 43249 and 58403.....
58361	7845	Shuttle Driver with 445c, for 1¼ in. to 1½ in. gauges, for 7-43 and 7-54 Machines.....
58362	—	Shuttle Race Body for 58365.....
58363	7842	“ “ Ring (inside) for 58365.....
58364	7842	“ “ “ (outside) for 58365.....
58365	7845	Shuttle Race complete, for 1¼ in. to 1½ in. gauges, for 7-43 and 7-54 Machines, Nos. 58362 to 58364 and six 134E.....
58366	7837	Throat Plate Body for 58369 and 58371..
58367	7837	“ “ Needle Hole Strip (left) for 58369.....
58368	7837	Throat Plate Needle Hole Strip (right) for 58369.....
58369	7837	Throat Plate complete for 58342, for 7-43 Machine, Nos. 58366 to 58368 and four 401D.....
58370	7838	Throat Plate Needle Hole Strip for 58371
58371	7838	Throat Plate complete, for 58343 for 7-43 Machine, Nos. 58366, two 58370 and four 401D.....
58372	7839	Throat Plate Body for 58375.....
58373	7839	“ “ Needle Plate (left) for 58375 and 58377.....
58374	7839	Throat Plate Needle Plate (right) for 58375 and 58377.....
58375	7839	Throat Plate complete for 58344, for 7-43 Machine, Nos. 58372 to 58374 and two each 401D and 691D.....
58376	7840	Throat Plate Body for 58377.....
58377	7840	Throat Plate complete for 58345, for 7-43 Machine, Nos. 58373, 58374, 58376 and two each 401D and 691D.....
58378	—	Driving Attachment Lever 19662 with 9D, 134E, 8984, 8991, 8992, 19663 and two 497E, for 19664 and 58379, obsolete

NO.	PLATE	NAME
58379	—	Driving Attachment complete for 58329 and 58445, for 7-3, 7-7, 7-13, 7-14, 7-17, 7-20, 7-24, 7-29, 7-30, 7-36, 7-44, 7-47 and 7-53 Machines and for 58330 for 7-11 Machine, Nos. 1520J, 6055, 9091, 11440, 14785, 58378, 122302, 122304, 122306 and 126210, obsolete.....
58380	—	Driving Attachment complete for 58334, 58444 and 58588, for 7-37 and 7-43 Machines, Nos. 1520J, 6055, 9091, 11440, 14785, 58286, 58336, 122304, 122306 and 126210, obsolete.....
58381	9622	Shuttle Tension Spring for 58404.....
58383	7835	Arm Shaft for 7-46 Machine.....
58384	—	Feed Lifting Rock Shaft Screw Center 564c with 1508J, for 7-1 to 7-8, 7-10, 7-11, 7-13, 7-15 to 7-18, 7-22, 7-24, 7-29, 7-32, 7-36, 7-40, 7-42, 7-44 to 7-47, 7-53 and 7-55 Machines.....
58384	—	Feed (lower) Lifting Rock Shaft Screw Center 564c with 1508J, for 7-30 Machine.....
58384	—	Feed Rock Shaft Screw Center 564c with 1508J, for 7-1 to 7-8, 7-10, 7-11, 7-13, 7-15 to 7-18, 7-22, 7-24, 7-29, 7-32, 7-36, 7-40, 7-42, 7-44 to 7-47, 7-53 and 7-55 Machines.....
58384	—	Feed (lower) Rock Shaft Screw Center 564c with 1508J, for 7-30 Machine.....
58385	9609	Throat Plate Needle Hole Strip for 58386
58386	9609	Throat Plate complete, for Nos. 23 to 26 Needles, for 19705, for 7-29 Machine, Nos. 19709, 58385 and two 389D.....
58387	9629	Cloth Plate for 7-50 to 7-52 and 7-54 Machines.....
58389	9610	Feed Dog, 13 teeth (10 teeth to the inch) for 58438, for 7-50 to 7-52 Machines....
58389	9610	Feed (lower) Dog, 13 teeth (10 teeth to the inch) for 1 in. gauge, for 58438, for 7-54 Machine.....
58390	9628	Feed Lifting Rock Shaft with 134E, 2022 and 19967, for 58391.....
58390	9628	Feed (lower) Lifting Rock Shaft with 134E, 2022 and 19967, for 58391.....
58391	—	Feed Lifting Rock Shaft complete for 7-50 to 7-52 Machines, Nos. 58390 and two 19819.....

NO.	PLATE	NAME
58391	—	Feed (lower) Lifting Rock Shaft complete for 7-54 Machine, Nos. 58390 and two 19819.....
58392	9628	Feed Rock Shaft for 58393.....
58392	9628	" (lower) Rock Shaft for 58393.....
58393	—	Feed Rock Shaft complete for 7-50 to 7-52 Machines, Nos. 58235 and 58392
58393	—	Feed (lower) Rock Shaft complete for 7-54 Machine, Nos. 58235 and 58392....
Nos. 58396 to 58398 for 7-40 and 7-53 MACHINES		
58396	—	Buff Wheel Clamp Carrier complete, for $\frac{3}{8}$ in. space between rows of stitching, Nos. 194E, 1480D, 9521, 19926, 19927, 19930, 19934, 19936, 19937, 19939, 19943, 19944, 50204D, 50205D, two 2049 and four 691F.....
58397	—	Buff Wheel Clamp Carrier complete, for $\frac{1}{8}$ in. space between rows of stitching, Nos. 194E, 1480D, 9521, 19926, 19927, 19934, 19936, 19937, 19939, 19943, 19944, 50204D, 50205D, 58325, two 2049 and four 691F.....
58398	—	Buff Wheel Clamp Carrier complete for, $\frac{1}{4}$ in. space between rows of stitching, Nos. 194E, 1480D, 9521, 19926, 19927, 19929, 19934, 19936, 19937, 19939, 19943, 19944, 50204D, 50205D, two 2049 and four 691F.....
58401	9626	Lifting Presser Bar Lifting Link for 7-13 and 7-15 Machines.....
58402	9627	Lifting Presser Bar Guide Bracket with 159E, 453C and 460C, for 7-5 to 7-8, 7-13 and 7-15 to 7-18 Machines.....
58403	—	Shuttle (outside) Cylinder 58359 with 1323F and 8780, for 58360.....
58404	—	Shuttle Cylinder 19977 with 773F and 58381, for 58526.....
58405	—	Shuttle (inside) Cylinder 58357 with 1323F and 8895, for 58358.....
58406	9618	Vibrating Presser Foot, for No. 31 needle, for 7-16 to 7-18 Machines.....
58407	9631	Balance Wheel and Pulley (tight) with two 354c, for 7-4, 7-8, 7-15, 7-18, 7-22, 7-24, 7-32, 7-40, 7-45 and 7-55 Machines
58408	9630	Belt Shifter Pulley (loose) for 11945.....

NO.	PLATE	NAME
58409	9623	Belt Shifter Pulley (loose) Flanged Bushing with two 435c, for 11945.....
58411	9631	Balance Wheel with two 354c, for Under Driver, for 7-2, 7-6, 7-16, 7-35 and 7-52 Machines.....
58413	9629	Cloth Plate for 58425, 58429, 58457 and 58584, for 7-54 Machine.....
58414	9610	Feed (lower) Dog, 13 teeth (10 teeth to the inch) for $1\frac{1}{8}$ in. and $1\frac{1}{4}$ in. gauges, for 58457 and 58584, for 7-54 Machine.
58415	9624	Feed (lower) Dog, 16 teeth (10 teeth to the inch) for $1\frac{3}{8}$ in. and $1\frac{1}{2}$ in. gauges, for 58425 and 58429, for 7-54 Machine.
58422	—	Throat Plate Body for 58425.....
58423	9624	" " Needle Hole Strip (left) for 58425.....
58424	—	Throat Plate Needle Hole Strip (right) for 58425.....
58425	9624	Throat Plate complete, for $1\frac{3}{8}$ in. gauge, for 58415, for 7-54 Machine, Nos. 58422 to 58424 and four 691D.....
58426	—	Throat Plate Body for 58429.....
58427	9624	" " Needle Hole Strip (left) for 58429.....
58428	—	Throat Plate Needle Hole Strip (right) for 58429.....
58429	9624	Throat Plate complete, for $1\frac{1}{2}$ in. gauge, for 58415, for 7-54 Machine, Nos. 58426 to 58428 and four 691D.....
58430	9618	Feed Dog, 4 teeth (8 teeth to the inch) for 58433, for 7-40 and 7-53 Machines..
58431	—	Throat Plate Body for 58433.....
58432	9618	" " Needle Plate for 58433.
58433	9618	Throat Plate complete for 58430, for 7-40 and 7-53 Machines, Nos. 219F, 58431 and 58432.....
58434	9628	Lifting Presser Bar Spring (flat) for 7-54 Machine.....
58435	—	Throat Plate Body for 58438.....
58436	9609	" " Needle Hole Strip (left) for 58438 and 58440.....
58437	—	Throat Plate Needle Hole Strip (right) for 58438 and 58440.....
58438	9610	Throat Plate complete for 58389, for 7-50 to 7-52 Machines, and for 1 in. gauge for 7-54 Machine, Nos. 58435 to 58437 and four 742D.....

NO.	PLATE	NAME
58439	—	Throat Plate Body for 58440.....
58440	9609	Throat Plate complete for 19761, for 7-26, 7-37 and 7-43 Machines, Nos. 58436, 58437, 58439 and four 742d.....
58441	—	Driving Attachment Lever 58248 with 9D, 134E, 8984, 8991, 8992, 58442 and two 497E, for 58443, obsolete.....
58442	9630	Driving Attachment Lever Bracket for 58441, obsolete.....
58443	—	Driving Attachment complete for 58334 and 58588, for 7-51 and 7-54 Machines, Nos. 1520r, 6055, 9091, 11440, 14785, 58336, 58441, 122304, 122306 and 126210, obsolete.....
58444	9628	Arm Shaft for 7-37 Machine.....
58445	9628	" " " 7-36 and 7-47 Machines....
58446	9629	Feed Bar for 7-50 to 7-52 Machines.....
58446	9629	" (lower) Bar for 7-54 Machine.....
58447	9627	Feed Rock Shaft Crank with 50124E, for 11599.....
58449	—	Bed Extension for 7-40, 7-53 and 7-55 Machines.....
58450	9627	Buff Wheel Clamp Carrier Rack for 7-40, 7-53 and 7-55 Machines.....
58451	9627	Buff Wheel Clamp Carrier Rack Clamping Plate for 7-40, 7-53 and 7-55 Machines.....
58454	—	Throat Plate Body for 58457 and 58584..
58455	9610	" " Needle Hole Strip (left) for 58457.....
58456	—	Throat Plate Needle Hole Strip (right) for 58457.....
58457	9610	Throat Plate complete, for 1½ in. gauge, for 58414, for 7-54 Machine, Nos. 58454 to 58456 and four 742d.....
58458	9616	Driving Attachment Brake Block Stud for 58460, 58461 and 58464.....
58459	9631	Driving Attachment Lever with 1036c, for 58460 and 58461.....
58460	—	Driving Attachment Lever 58459 with 134E, 8984, 8991, 8992, 58458, 58462 and two 497E, for 58509.....
58461	—	Driving Attachment Lever 58459 with 134E, 8984, 8991, 8992, 58458, 58465 and two 497E, for 58510.....
58462	9630	Driving Attachment Lever Bracket for 58460 and 58464.....

NO.	PLATE	NAME
58463	9631	Driving Attachment Lever with 1036c, for 58464.....
58464	—	Driving Attachment Lever 58463 with 134E, 8984, 8991, 8992, 58458, 58462 and two 497E, for 58508.....
58465	9630	Driving Attachment Lever Bracket for 58461.....
58466	9608	Face Plate Thread Eyelet for 58217.....
58508	—	Driving Attachment complete for 58329 and 58445, for 7-3, 7-7, 7-13, 7-14, 7-17, 7-20, 7-24, 7-29, 7-30, 7-36, 7-44, 7-47 and 7-53 Machines, and for 58330 for 7-11 Machine, Nos. 1520r, 6055, 9091, 11440, 14785, 58464, 122302, 122304, 122306 and 126212.....
58509	—	Driving Attachment complete for 58334, 58444 and 58588, for 7-37 and 7-43 Machines, Nos. 1520r, 6055, 9091, 11440, 14785, 58336, 58460, 122304, 122306 and 126212.....
58510	—	Driving Attachment complete for 58334 and 58588, for 7-51 and 7-54 Machines, Nos. 1520r, 6055, 9091, 11440, 14785, 58336, 58461, 122304, 122306 and 126212.....
58511	9623	Feed Cam with two 445c, for 7-14, 7-20 and 7-35 Machines.....
58511	9623	Feed (upper) Cam with two 445c, for 7-30, 7-43 and 7-54 Machines.....
58512	9611	Shuttle (inside) Cylinder for 58513.....
58513	—	" " " 58512 with 774F and 58515, for 58516.....
58514	—	Shuttle (inside) Frame 19573 with 590D, 11854, 12002 and 58979, for 58516.....
58515	9611	Shuttle (inside) Tension Spring for 58513
58516	9611	Shuttle (cylinder) inside, 3 in. diam., complete, for 7-22, 7-36, 7-42, 7-44 and 7-45 Machines, Nos. 8961, 11910, 58513 and 58514.....
58517	9615	Shuttle (outside) Cylinder for 58518..
58518	—	" " " 58517 with 774F and 58520, for 58521.....
58519	—	Shuttle (outside) Frame 19574 with 590D, 11854, 12002 and 58979, for 58521.....
58520	9615	Shuttle (outside) Tension Spring for 58518

NO.	PLATE	NAME
58521	9615	Shuttle (cylinder) outside, 3 in. diam., complete for 7-22, 7-36, 7-42, 7-44 and 7-45 Machines, Nos. 8961, 11910, 58518 and 58519.....
58522	9608	Face Plate Thread Guard for 58215.....
58523	9612	Shuttle Frame for 58524.....
58524	—	“ “ 58523 with 12002, 58979 and 122419, for 58525 and 58526.....
58525	9613	Shuttle (cylinder) 3 in. diam., complete for 7-1 to 7-8, 7-10, 7-11, 7-13 to 7-15, 7-20, 7-30, 7-35, 7-40, 7-46, 7-47, 7-53 and 7-55 Machines, Nos. 11910, 58213, 58524 and 58527.....
58526	9613	Shuttle (cylinder) 3 in. diam., complete for 7-16 to 7-18 Machines, Nos. 11910, 58404, 58524 and 58527.....
58527	9621	Shuttle Cylinder Hinge Pin for 58525 and 58526.....
58529	9627	Buff Wheel Clamp Carrier Cap for 58536 to 58538.....
58530	—	Buff Wheel Clamp Carrier Spindle 19942 with 58531 and three 401D, for 58536 to 58538.....
58531	9616	Buff Wheel Clamp Carrier Spindle Plate with three 9199, for 58530.....
58532	9608	Buff Wheel Clamp Carrier Spindle Screw Stud for 58536 to 58538.....
58533	9616	Buff Wheel Clamp Carrier Spindle Screw Stud Thumb Nut with two 58534 and four 1161E, for 58536 to 58538.....
58534	9621	Buff Wheel Clamp Carrier Spindle Screw Stud Thumb Nut Spring for 58533....
58535	9616	Buff Wheel Clamp Carrier Spindle Screw Stud Thumb Nut Washer for 58536 to 58538.....

Nos. 58536 TO 58544 FOR 7-55 MACHINE

58536	—	Buff Wheel Clamp Carrier complete, for $\frac{3}{8}$ in. space between rows of stitching, Nos. 194E, 1480D, 9521, 19926, 19930, 19934, 19936, 19937, 19939, 19944, 50204D, 50205D, 58529, 58530, 58532, 58533, 58535, two 2049 and four 691F.....
-------	---	---

NO.	PLATE	NAME
58537	—	Buff Wheel Clamp Carrier complete, for $\frac{1}{8}$ in. space between rows of stitching, Nos. 194E, 1480D, 9521, 19926, 19934, 19936, 19937, 19939, 19944, 50204D, 50205D, 58325, 58529, 58530, 58532, 58533, 58535, two 2049 and four 691F..
58538	—	Buff Wheel Clamp Carrier complete, for $\frac{1}{4}$ in. space between rows of stitching, Nos. 194E, 1480D, 9521, 19926, 19929, 19934, 19936, 19937, 19939, 19944, 50204D, 50205D, 58529, 58530, 58532, 58533, 58535, two 2049 and four 691F..
58539	9612	Feed Dog, 4 teeth (10 teeth to the inch) for 58543.....
58540	9617	Lifting Presser Foot with 168E.....
58541	—	Throat Plate Body for 58543.....
58542	9612	“ “ Needle Plate for 58543.....
58543	9612	Throat Plate complete for 58539, Nos. 219F, 58541 and 58542.....
58544	9621	Vibrating Presser Foot.....
58548	9608	Arm Oil Tube, for oiling Arm Shaft Intermediate Bearing, for 7-26, 7-37, 7-43, 7-50 to 7-52 and 7-54 Machines.....
58549	9608	Bed Oil Tube with 52045, for oiling Feed Lifting and Feed Rock Shaft (front) Bearings.....
58550	9625	Oscillating Rock Shaft for 58551.....
58551	—	Oscillating Rock Shaft complete for 7-26, 7-37, 7-43, 7-50 to 7-52 and 7-54 Machines, Nos. 1503J, 11165, 51227C, 58550, 58555 and 58595.....
58552	9625	Oscillating Rock Shaft Hinge Pin for 58595.....
58553	—	Oscillating Rock Shaft Oil Tube with 49191, for 58555.....
58554	9616	Oscillating Rock Shaft Oil Tube Joint for 58555.....
58555	9616	Oscillating Rock Shaft Oil Tube with Joint complete, for 58551, Nos. 58553, 58554 and 68350.....
58556	9626	Vibrating Presser Bar Spring for 7-5 to 7-8 and 7-16 to 7-18 Machines.....
58563	9631	Balance Wheel (two speed) with two 909C, for 7-42 Machine.....
58564	9608	Arm Oil Tube, for oiling Arm Shaft Intermediate Bearing, for 7-1 to 7-8, 7-11, 7-13, 7-14 to 7-18, 7-20, 7-22, 7-29, 7-30, 7-35, 7-36 and 7-46 Machines....

NO.	PLATE	NAME
58565	9608	Arm Oil Tube, for oiling Arm Shaft Intermediate Bearing, for 7-10, 7-32, 7-40, 7-42, 7-44, 7-45, 7-47, 7-53 and 7-55 Machines.....
58566	—	Oscillating Rock Shaft complete for 7-1 to 7-8, 7-10, 7-11, 7-13, 7-15 to 7-18, 7-22, 7-29, 7-30, 7-32, 7-36, 7-40, 7-42, 7-44 to 7-47, 7-53 and 7-55 Machines, Nos. 1508J, 11165, 51237c, 58570, 58573 and 58586.....
58567	—	Oscillating Rock Shaft Oil Tube with 58569, for 58570.....
58568	9616	Oscillating Rock Shaft Oil Tube Joint for 58570.....
*58569	—	Oscillating Rock Shaft Oil Tube Sleeve for 58567.....
58570	9616	Oscillating Rock Shaft Oil Tube complete for 58566 and 58572, Nos. 58567, 58568 and 127848.....
58571	9625	Oscillating Rock Shaft for 58572.....
58572	—	Oscillating Rock Shaft complete for 7-14, 7-20 and 7-35 Machines, Nos. 1508J, 11165, 51237c, 58570, 58571 and 58586.....
58573	9625	Oscillating Rock Shaft for 58566.....
58578	9618	Lifting Presser Bar Rock Shaft Adjusting Arm with 453c, for 7-32, 7-40, 7-42, 7-44, 7-45, 7-53 and 7-55 Machines.....
58579	9626	Thread Take-up Spring (.083 in. wire) for general work, for 19596, 19885 and 58217.....
58580	9626	Thread Take-up Spring (.095 in. wire) for extra heavy work, for 19596, 19885 and 58217.....
58581	9626	Thread Take-up Spring (.083 in. wire) for general work, for 19865 and 58215..
58582	9626	Thread Take-up Spring (.095 in. wire) for extra heavy work, for 19865 and 58215.....
58583	9610	Throat Plate Needle Hole Strip for 58584
58584	9610	Throat Plate complete for 1½ in. gauge, for 58414, for 7-54 Machine, Nos. 58454, two 58583 and four 742n.....
58585	9625	Oscillating Rock Shaft Hinge Pin for 58586.....
58586	—	Oscillating Rock Shaft Hinge Pin 58585 with 1508J, for 58566 and 58572.....

NO.	PLATE	NAME
58588	4495	Arm Shaft for 7-43, 7-51 and 7-54 Machines.....
58589	—	Tension Screw Stud 411E with 1560c, for 11420 and 58317.....
58590	—	Thread Retaining Screw Stud 686E with 1560c, for 11041.....
58591	—	Tension Screw Stud 850E with 1560c, for 11871.....
58592	—	Thread Retaining Screw Stud 633E with 1560c, for 11546 and 19587.....
58593	—	Tension Screw Stud 709E with 1535E, for 19701.....
58594	—	Feed Lifting Rock Shaft Screw Center 294c with 1503J, for 7-26 and 7-37 Machines.....
58594	—	Feed (lower) Lifting Rock Shaft Screw Center (right) 294c with 1503J, for 7-43 and 7-54 Machines.....
58594	—	Feed Rock Shaft Screw Center 294c with 1503J, for 7-26, 7-37, and 7-50 to 7-52 Machines.....
58594	—	Feed (lower) Rock Shaft Screw Center (right) 294c with 1503J, for 7-43 and 7-54 Machines.....
58595	—	Oscillating Rock Shaft Hinge Pin 58552 with 1503J, for 58551.....
58596	—	Tension Screw Stud 632E with 1560c, for 11042.....
58597	—	Thread Retaining Screw Stud 606E with 1560c, for 11503.....
58598	—	Tension Screw Stud 607E with 1560c, for 12042.....
58599	—	Tension Screw Stud 710E with 1535E, for 19889.....
58600	—	Thread Retaining Screw Stud 408E with 1560c, for 11426.....
58601	—	Feed Lifting Rock Shaft Screw Center (front) 1015c with 1503J, for 7-50 to 7-52 Machines.....
58601	—	Feed (lower) Lifting Rock Shaft Screw Center (left) 1015c with 1503J, for 7-43 and 7-54 Machines.....
58601	—	Feed (lower) Rock Shaft Screw Center (left) 1015c with 1503J, for 7-43 and 7-54 Machines.....
58795	4499	Tension Wheel for 19701 and 19889.....
58979	9611	Shuttle Cylinder Latch for 58524.....

NO.	PLATE	NAME
58979	9611	Shuttle (inside) Cylinder Latch for 58514
58979	9611	" (outside) Cylinder Latch for 58519
60213	9621	Bobbin Winder Bobbin Position Pin for 60215.....
60214	4486	Bobbin Winder Spindle for 60217.....
60215	4486	" " " Shaft with 454c and 60213, for 60217.....
60216	4486	Bobbin Winder Stop Latch for 60217.....
60217	4485	Bobbin Winder for 60219, 60273, 60278 and 60279, Nos. 2269, 11107, 41441, 41894, 41896, 41897, 41899, 43270, 60214 to 60216 and two 4784.....
60218	4490	Bobbin Winder Bracket for 60219.....
60219	—	Bobbin Winder (swinging automatic, left hand) complete for 58247 and 58336, for 7-37 and 7-43, 7-51 and 7-54 Machines, Nos. 9842, 41823, 50124D, 60217, 60218 and three 894E.....
60227	4490	Bobbin Winder Bracket for 60277 and 60279.....
60259	4490	Bobbin Winder Bracket for 60260.....
60260	—	Bobbin Winder (swinging automatic, left hand) complete for 11910, Nos. 9842, 41823, 41900, 50124D, 60259 and three 894E.....
60264	4497	Bobbin Winder Bracket for 60278.....
60271	4490	" " " " 60272 and 60273.....
60272	—	Bobbin Winder (swinging automatic, left hand) complete for 11910, for 11438 and 122302, for 7-3, 7-7, 7-11, 7-13, 7-14, 7-17, 7-20, 7-24, 7-30, 7-36, 7-47 and 7-53 Machines, Nos. 9842, 41823, 41900, 50124D, 60271 and three 894E.....
60273	—	Bobbin Winder (swinging automatic, left hand) complete, for 16901, for 11438 and 122302, for 7-29 Machine, Nos. 9842, 41823, 50124D, 60217, 60271 and three 894E.....
60274	4497	Bobbin Winder Bracket for 60275.....
60275	—	Bobbin Winder (swinging automatic, left hand) complete for 11910, for 11356, for 7-2, 7-4, 7-6, 7-8, 7-15, 7-16, 7-18, 7-22, 7-24, 7-32, 7-35, 7-40 and 7-55 Machines, Nos. 9842, 41823, 41900, 50124D, 60274 and three 894E.....

NO.	PLATE	NAME
60277	—	Bobbin Winder (swinging automatic, left hand) complete for 11910, for 11358, for 7-1, 7-5, 7-16, 7-34 and 7-46 Machines, and for 58249 for 7-42 Machine, Nos. 9842, 41823, 41900, 50124D, 60227 and three 894E.....
60278	—	Bobbin Winder (swinging automatic, left hand) complete for 16901, for 19991, for 7-26 and 7-50 Machines, Nos. 9842, 41823, 50124D, 60217, 60264 and three 894E.....
60279	—	Bobbin Winder (swinging automatic, left hand) complete for 16901, for 11358, for 7-52 Machine, Nos. 9842, 41823, 50124D, 60217, 60227 and three 894E..
60502	—	Driving Attachment Treadle Bracket (right) 46681 with two wood screws 1 in. No. 14, for 126209 and 126211....
60608	7285	Bobbin Winder Thread Unwinder Thread Guard for 60609.....
60608	7285	Thread Unwinder Thread Guard for 60609
60609	—	Bobbin Winder Thread Unwinder Thread Guard complete for 41454 and 41823, Nos. 330E, 828c, 1560c, 2103, 5769, 17547, 60608 and two 2102.....
60609	—	Thread Unwinder Thread Guard complete for 60637, Nos. 330E, 828c, 1560c, 2103, 5769, 17547, 60608 and two 2102.....
60610	7833	Thread Unwinder Thread Guard for 60611.....
60611	—	Thread Unwinder Thread Guard complete for 60612 and 60613, Nos. 330E, 828c, 1560c, 2103, 5769, 17547, 60610 and two 2102.....
60612	7833	Thread Unwinder complete, for three large spools of thread, for No. 7 Two-Needle Machines when set flush with table, Nos. 27557, 27560, 27778, 60611 and three wood screws 1¼ in. No. 12.....
60613	—	Thread Unwinder complete, for three large spools of thread, for No. 7 Two-Needle Machines, Nos. 27557, 27693, 27778, 60611 and three wood screws 1¼ in. No. 12.....
60626	9629	Driving Attachment Treadle Pitman complete for 126212, Nos. two each 9079 and 27639.....

NO.	PLATE	NAME
*60630	—	Bobbin Winder Stop Latch 41557 with 2269 and 41446, for 41558 and 41900...
60636	7831	Thread Unwinder Holder with 138E, for 60637.....
60637	—	Thread Unwinder complete, for two large spools of thread, for 5201, for 25207, Nos. 27556, 27693, 60609, 60636 and two wood screws 1¼ in. No. 12.....
60858	9623	Driving Attachment Treadle Hanging Hook for 126212.....
60988	9623	Bridle Iron Packing for 41124.....
64052	9617	Lifting Collar with 1149c, for 19536, 19648 and 19879.....
68350	9608	Arm Oil Cup, for oiling Arm Shaft Front and Back Bearings, for 7-26, 7-37, 7-43, 7-50 to 7-52 and 7-54 Machines.....
68350	9608	Oscillating Rock Shaft Oil Tube Oil Cup for 58555.....
120146	—	Cloth Plate for 120147, for 7-22 and 7-36 Machines.....
120147	7826	Hemmer on Slide 120148 with two 50027D, for heavy duck, for 7-22 and 7-36 Machines.....
120148	—	Hemmer Slide for 120147.....
120163	7826	Lap Seam Guide (left hand, adjustable) on Slide 120164, for tent work, for No. 7 Two-Needle Machines.....
120164	—	Lap Seam Guide Slide for 120163.....
120344	4484	Oiler (copper plated) with 120345 (Accessories).....
120345	4484	Oiler Spout, 5 in. long, for 120344.....
120571	9611	Shuttle Cylinder Opener (Accessories).....
120690	9626	Guide with Ridge, for 7-11 and 7-46 Machines.....
122301	—	Balance Wheel with two 354c, for 122302
122301	—	Driving Attachment Balance Wheel with two 354c, for 122302.....
122302	4496	Balance Wheel 122301 with 11442, 122469, two 1402E and four 401E, for 7-3, 7-7, 7-11, 7-13, 7-14, 7-17, 7-20, 7-24, 7-29, 7-30, 7-36, 7-44, 7-46, 7-47 and 7-53 Machines.....
122302	4496	Driving Attachment Balance Wheel 122301 with 11442, 122469, two 1402E and four 401E, for 58379 and 58508.....
122303	—	Balance Wheel Ball Ring for 122304.....

NO.	PLATE	NAME
122303	—	Driving Attachment Balance Wheel Ball Ring for 122304.....
122304	4493	Balance Wheel Ball Ring 122303 with eighteen 25362, for 7-3, 7-7, 7-11, 7-13, 7-14, 7-17, 7-20, 7-24, 7-29, 7-30, 7-36, 7-37, 7-43, 7-44, 7-46, 7-47, 7-51, 7-53 and 7-54 Machines.....
122304	4493	Driving Attachment Balance Wheel Ball Ring 122303 with eighteen 25362, for 58379, 58380, 58443 and 58508 to 58510
122306	4493	Balance Wheel Ball Washer (left) for 7-3, 7-7, 7-11, 7-13, 7-14, 7-17, 7-20, 7-24, 7-29, 7-30, 7-36, 7-37, 7-43, 7-44, 7-46, 7-47, 7-51, 7-53 and 7-54 Machines.....
122306	4493	Driving Attachment Balance Wheel Ball Ring Washer (left) for 58379, 58380, 58443 and 58508 to 58510.....
122419	9621	Shuttle Cylinder Latch Spring for 58524
122469	9616	Balance Wheel Ball Washer (right) for 58336 and 122302.....
122469	9616	Driving Attachment Balance Wheel Ball Ring Washer (right) for 58336 and 122302.....
126036	9630	Driving Attachment Treadle for 126037 and 126209.....
126037	—	Driving Attachment Treadle 126036 with 2718R, 50581R and 126038, for 126211
126038	9623	Driving Attachment Treadle Extension for 126037.....
126205	9623	Driving Attachment Treadle Bracket (left) for 126206.....
126206	—	Driving Attachment Treadle Bracket (left) complete for 126209 and 126211, Nos. 23258, 126205, 126207, 126208 and two wood screws 1 in. No. 14.....
126207	9621	Driving Attachment Treadle Bracket (left) Hook for 126206.....
126208	9621	Driving Attachment Treadle Bracket (left) Hook Rivet for 126206.....
126209	—	Driving Attachment Treadle complete for 126210, Nos. 60502, 126036 and 126206, obsolete.....
126210	—	Driving Attachment Treadle and Pitman complete for 19664, 19862, 58379, 58380 and 58443, Nos. 27640 and 126209 obsolete.....

302 NUMERICAL LIST OF PARTS

NO.	PLATE	NAME
126211	—	Driving Attachment Treadle complete for 126212, Nos. 60502, 126037 and 126206.....
126212	—	Driving Attachment Treadle and Pitman complete for 58508 to 58510, Nos. 60626, 60858 and 126211.....
127848	9608	Arm Oil Cup, for oiling Arm Shaft Front and Back Bearings, for 7-1 to 7-8, 7-10, 7-11, 7-13 to 7-18, 7-20, 7-22, 7-29, 7-30, 7-32, 7-35, 7-36, 7-40, 7-42, 7-44 to 7-47, 7-53 and 7-55 Machines.....
127848	9608	Oscillating Rock Shaft Oil Tube Oil Cup for 58570.....
150208	9629	Driving Attachment Pitman Rod (lower) Spring for 27640, obsolete.....

Genuine Singer Needles should be used in Singer Machines. These Needles and their Containers are marked with the Company's Trade Mark "SIMANCO." 1

Needles in Containers marked "For Singer Machines" are not Singer made needles. 2

PLATE 609—ONE-FOURTH SIZE

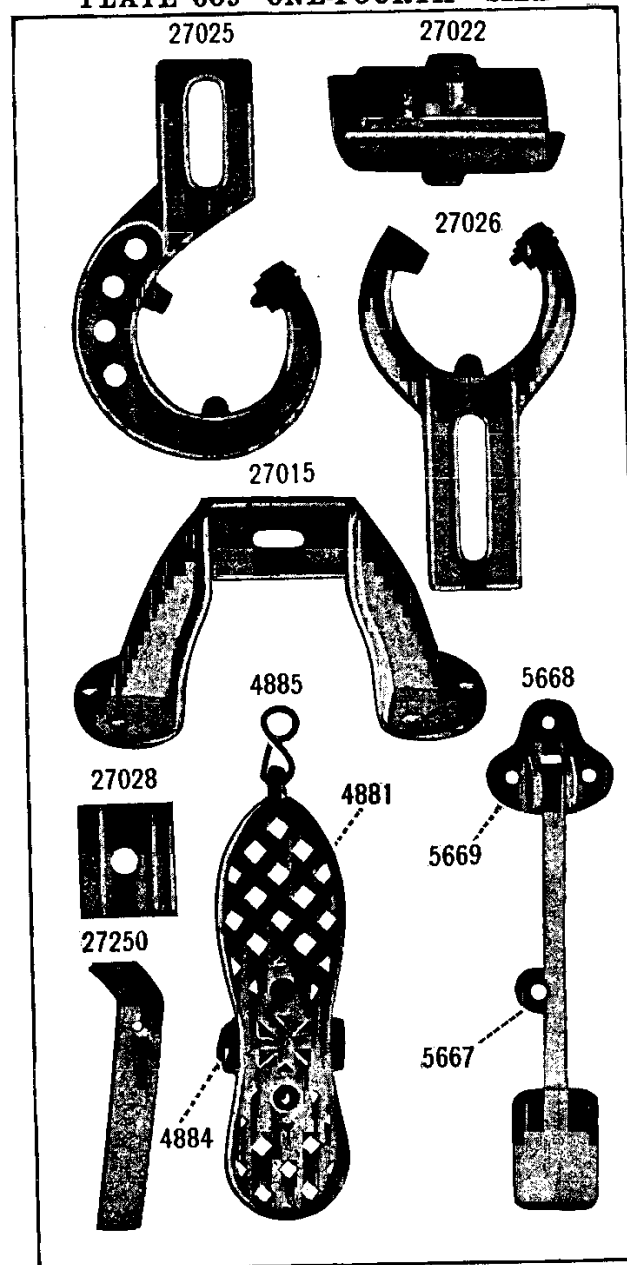

PLATE 825—ONE-FOURTH SIZE

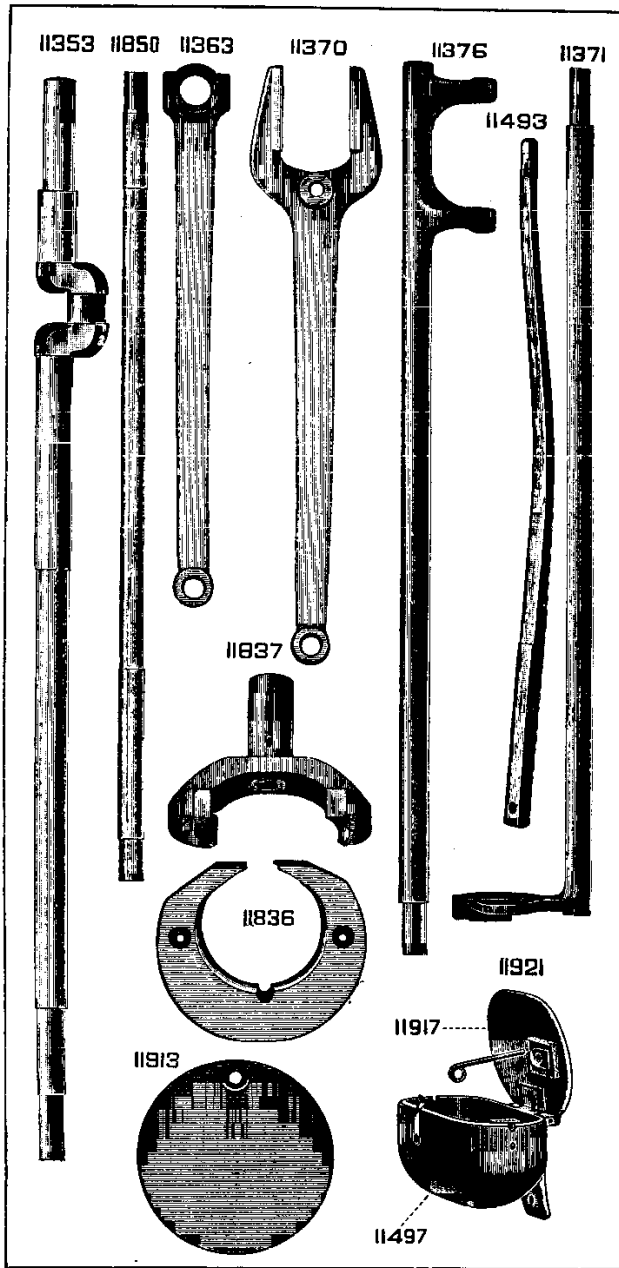

PLATE 826—ONE-FOURTH SIZE

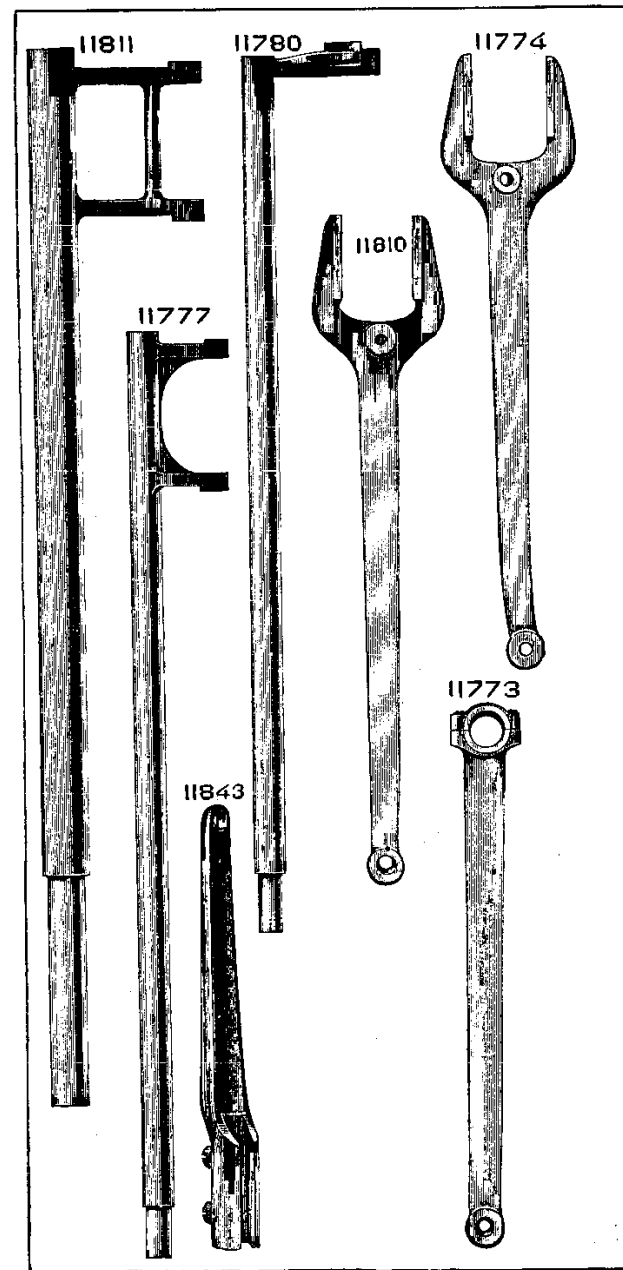

PLATE 827—ONE-HALF SIZE

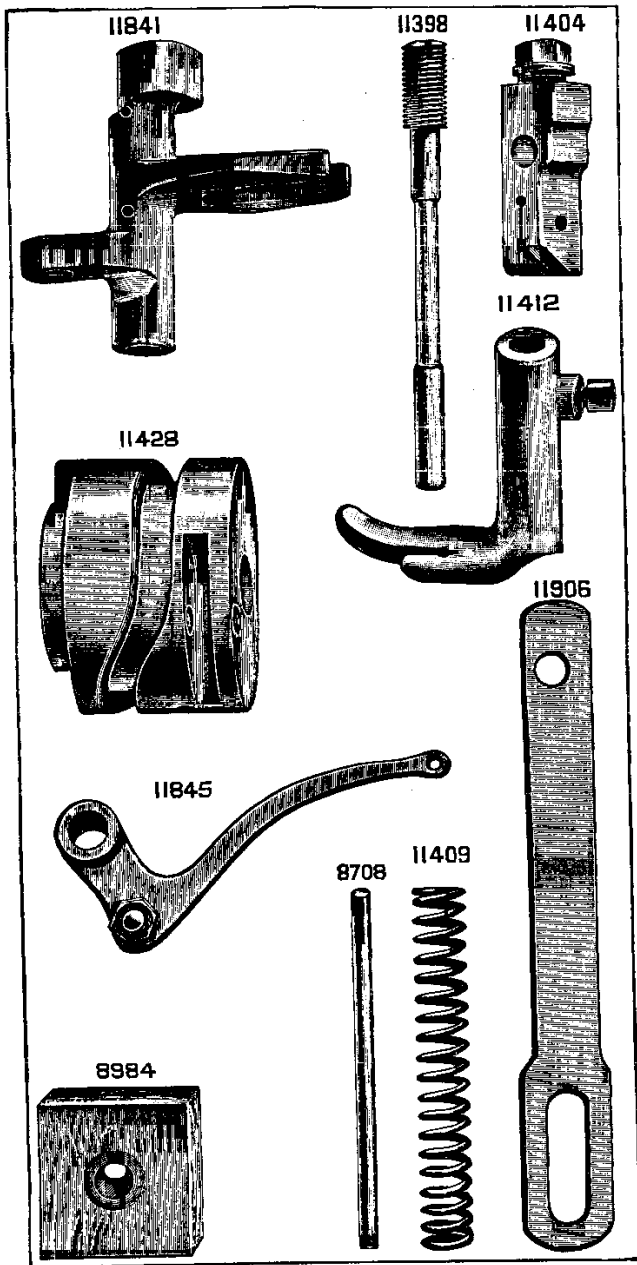

PLATE 828—ONE-HALF SIZE

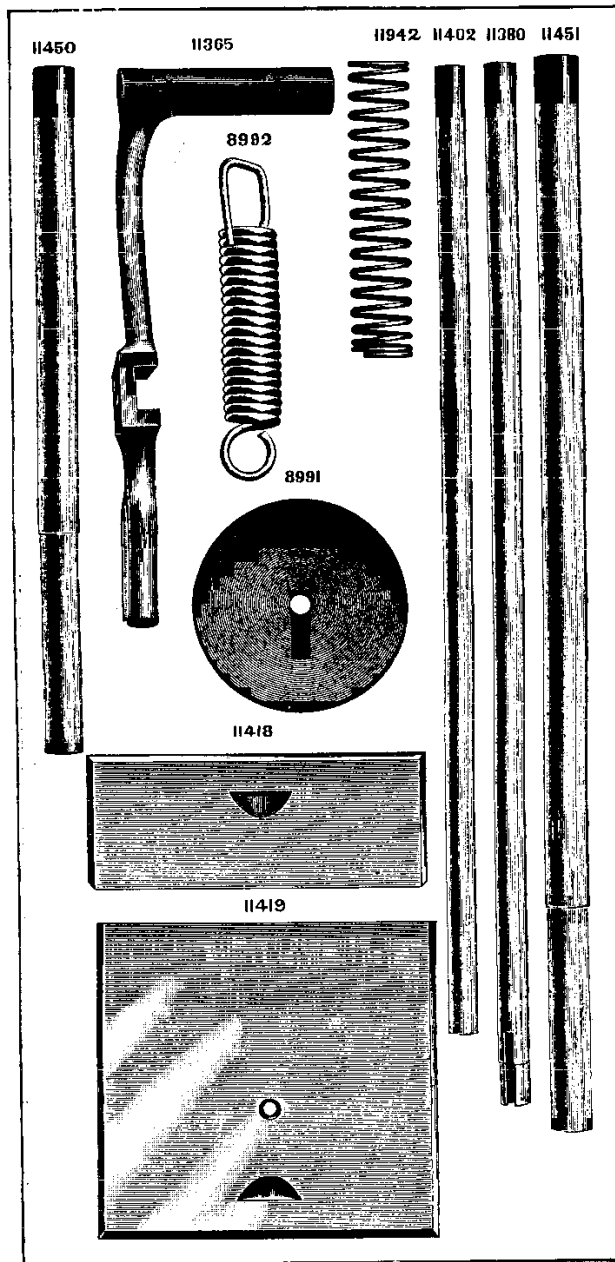

PLATE 829—ONE-HALF SIZE

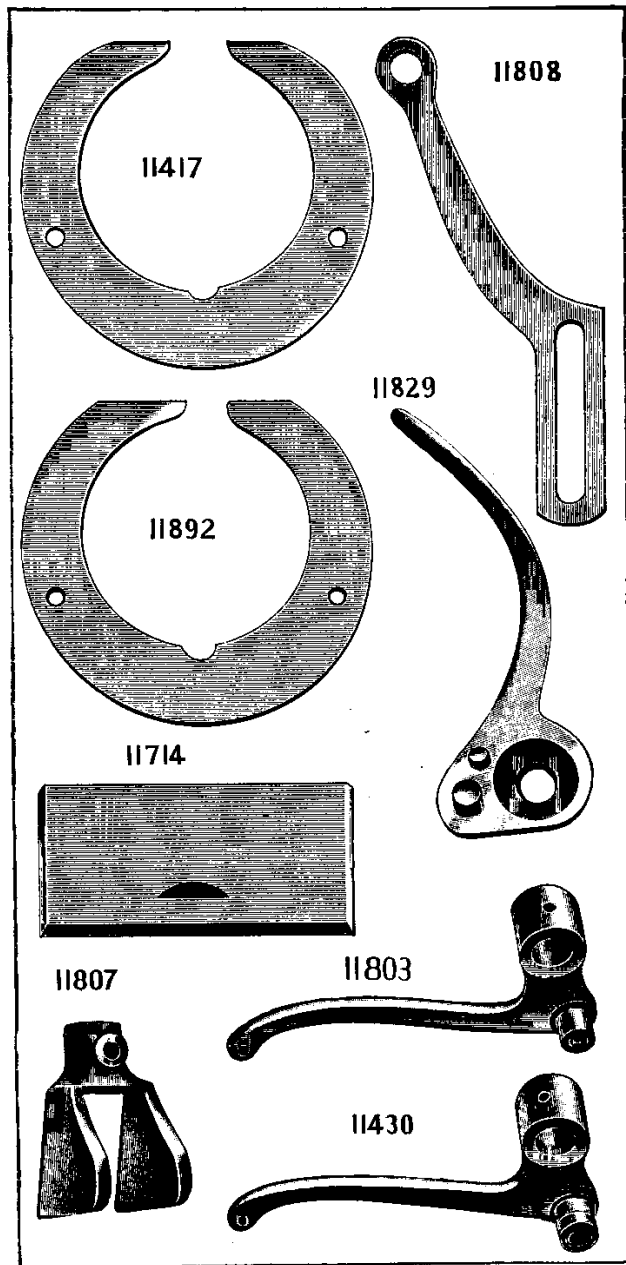

PLATE 830—ONE-HALF SIZE

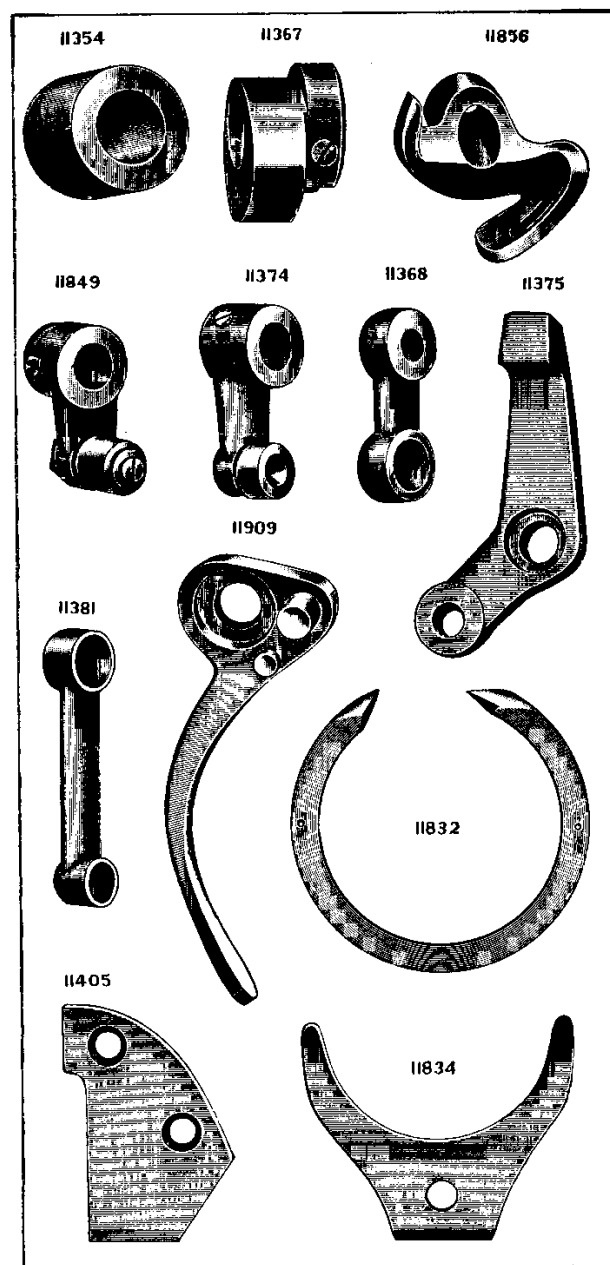

PLATE 831—ONE-HALF SIZE

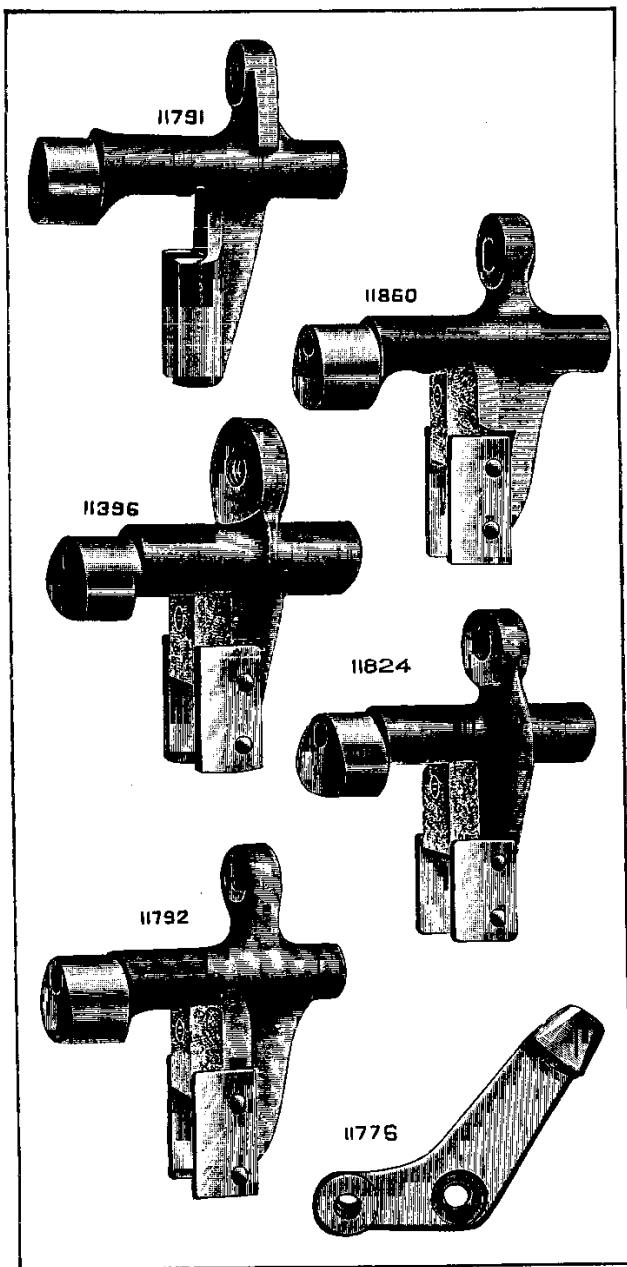
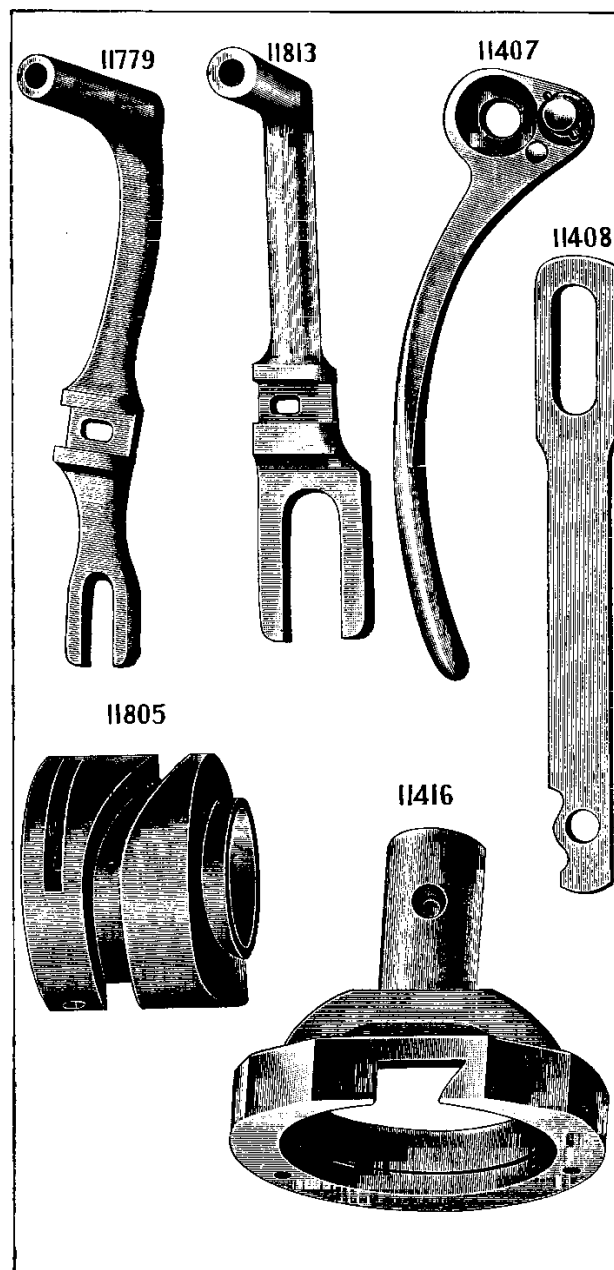

PLATE 832—ONE-HALF SIZE



From the library of: Diamond Needle Corp

PLATE 833—FULL SIZE

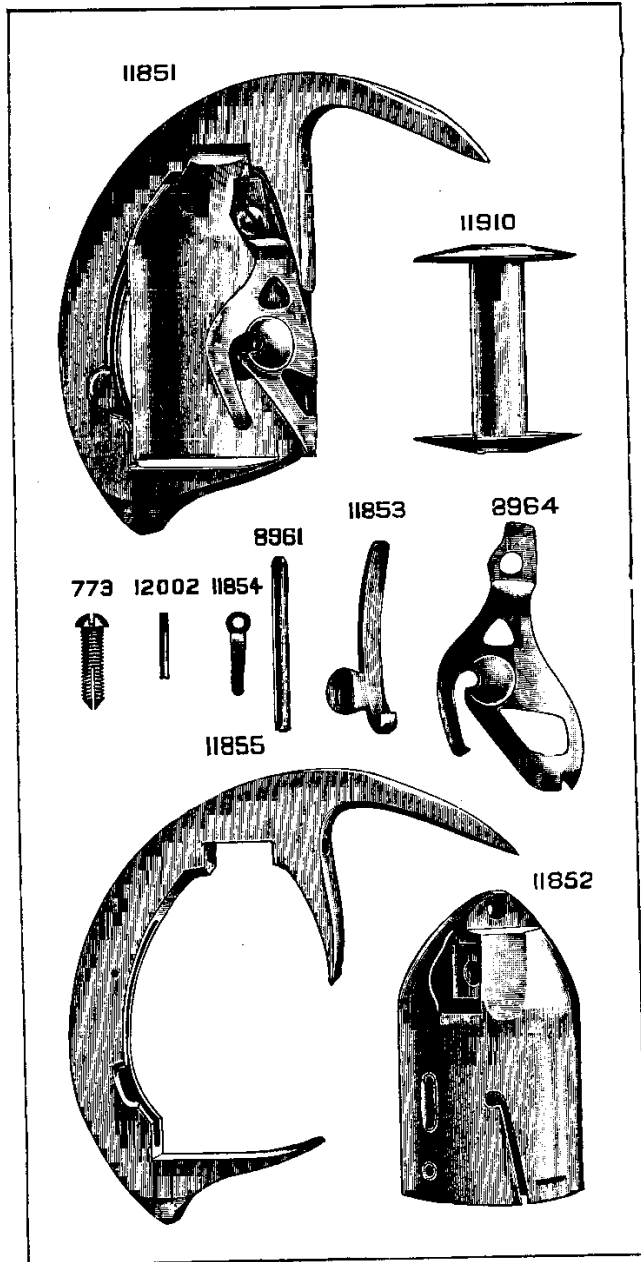

PLATE 834—FULL SIZE

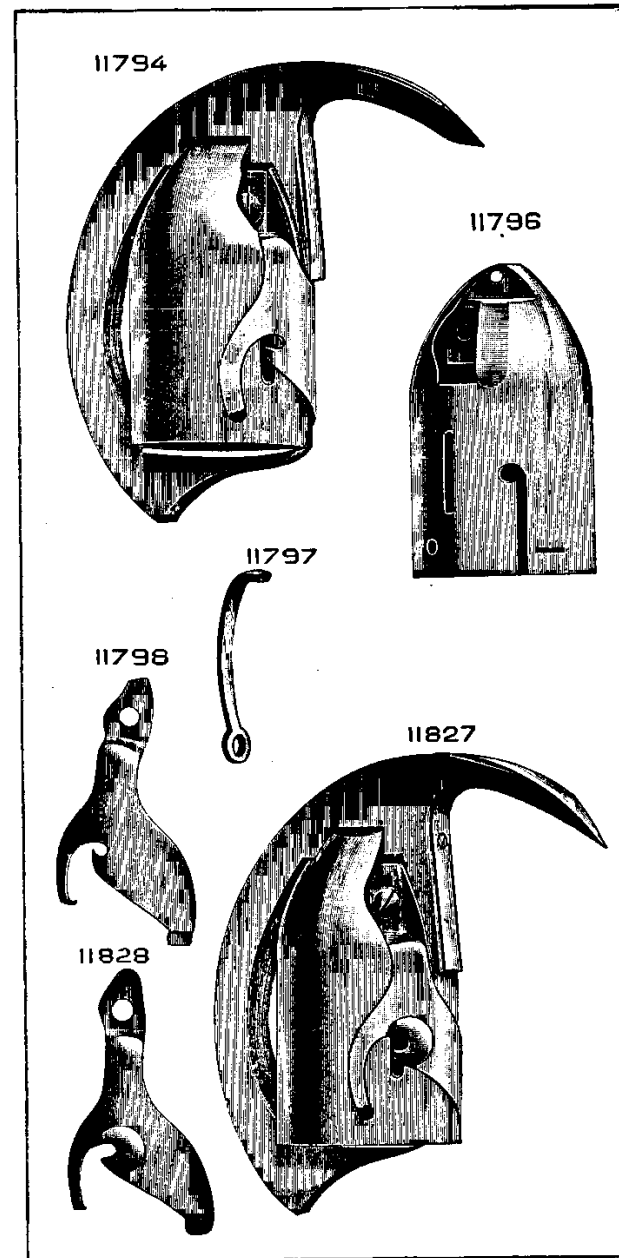

PLATE 835—FULL SIZE

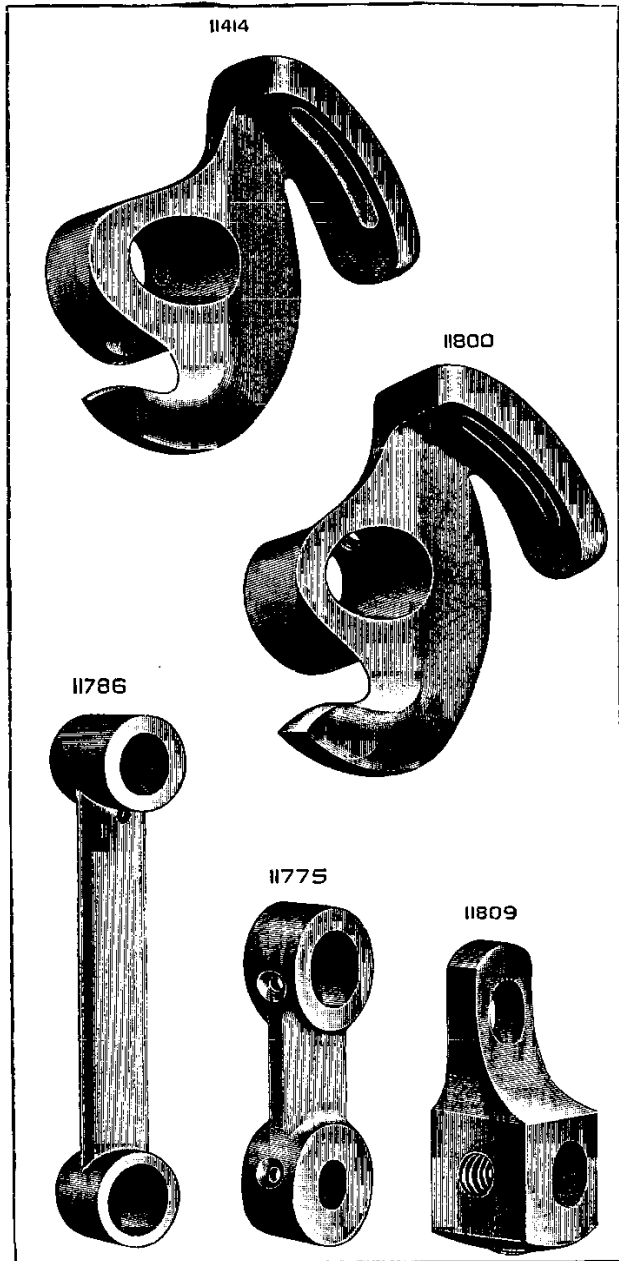

PLATE 836—FULL SIZE

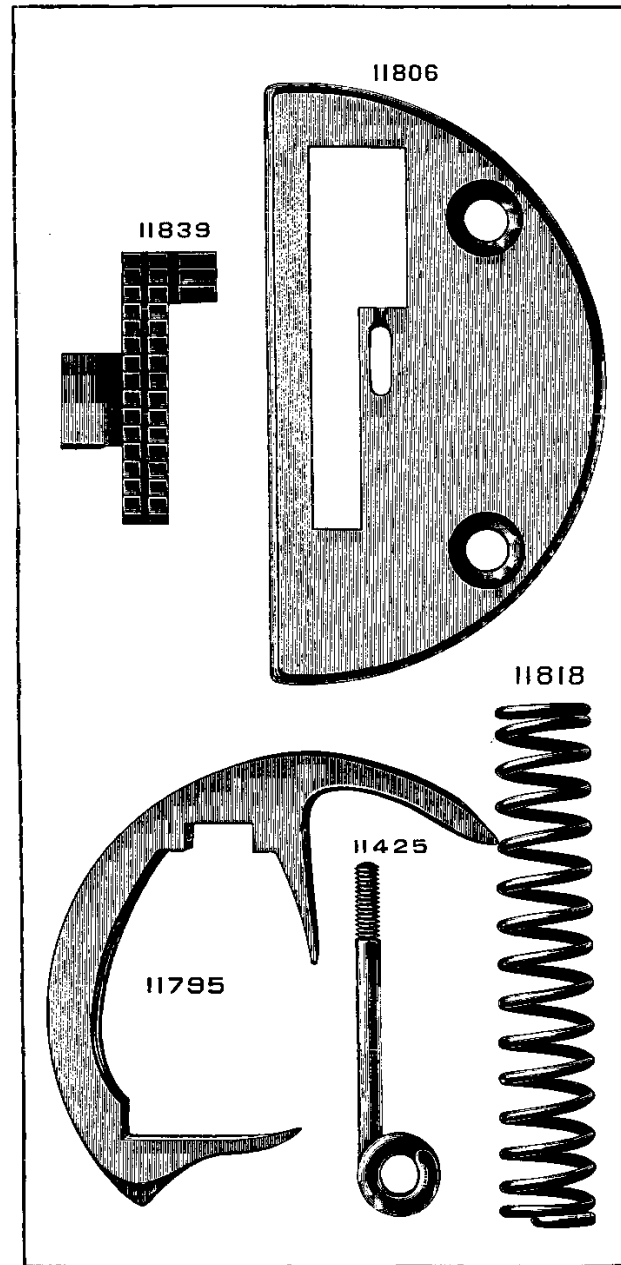

PLATE 837—FULL SIZE

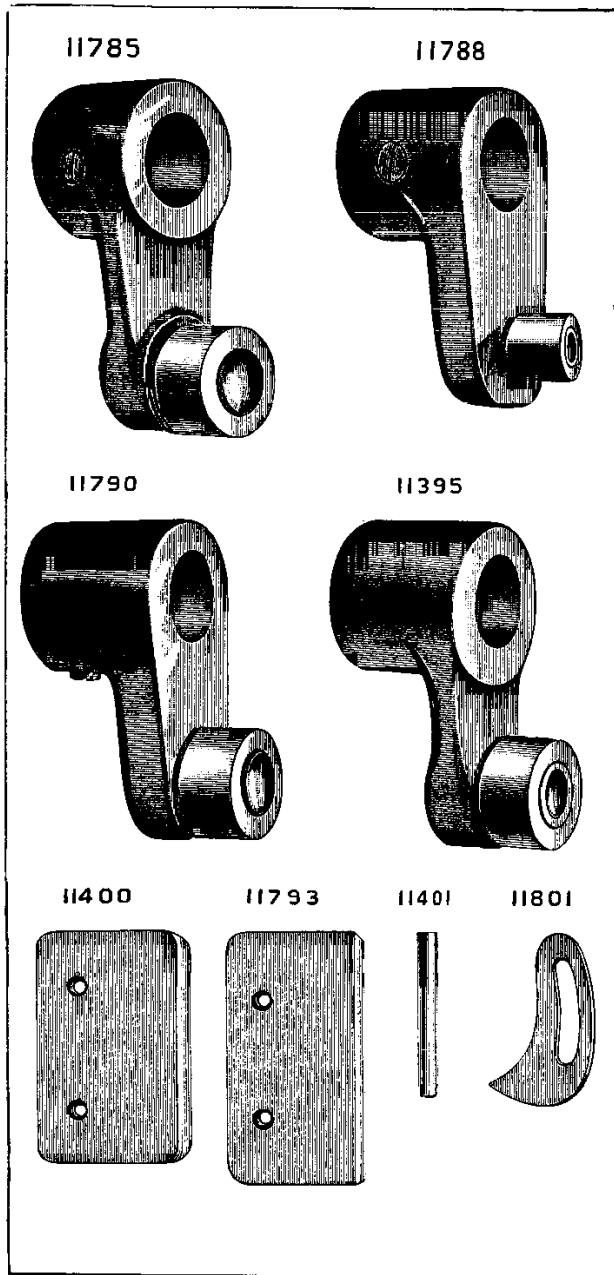

PLATE 838—ONE-FOURTH SIZE

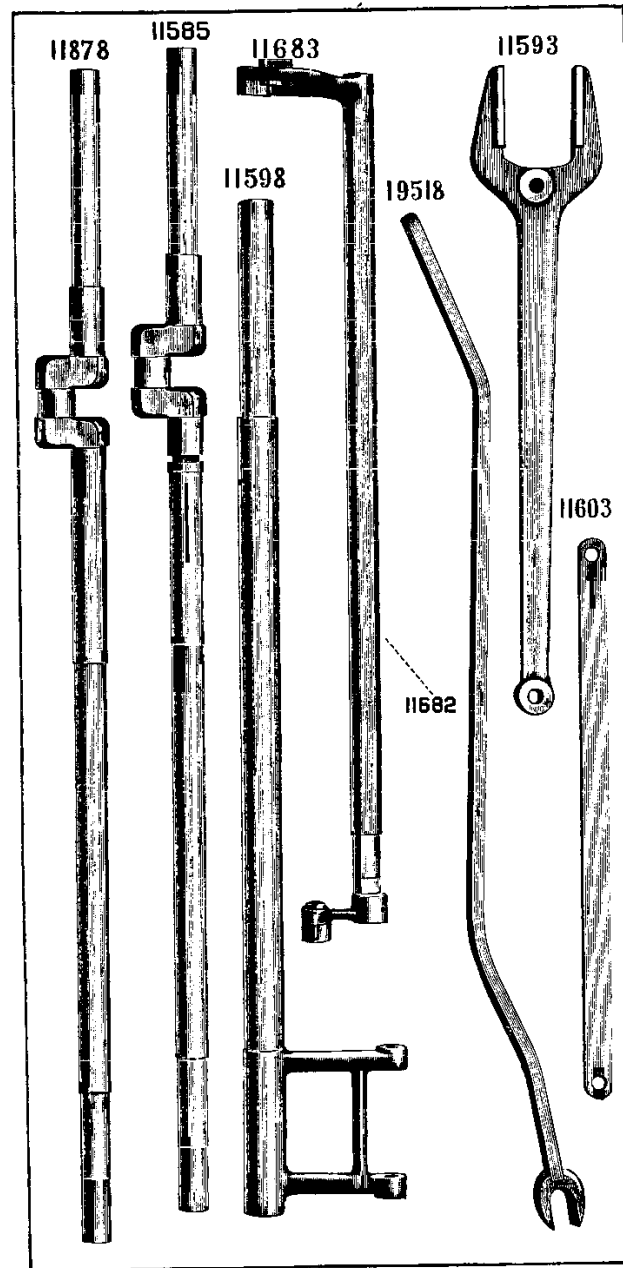

PLATE 839—ONE-HALF SIZE

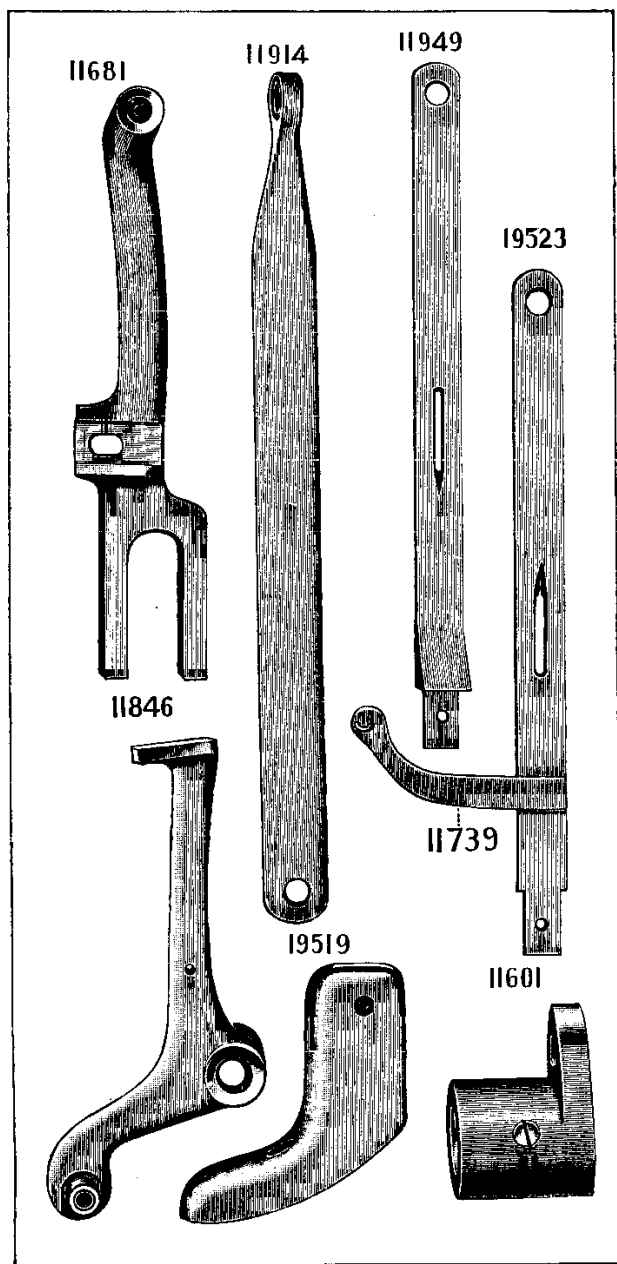

PLATE 840—ONE-FOURTH SIZE

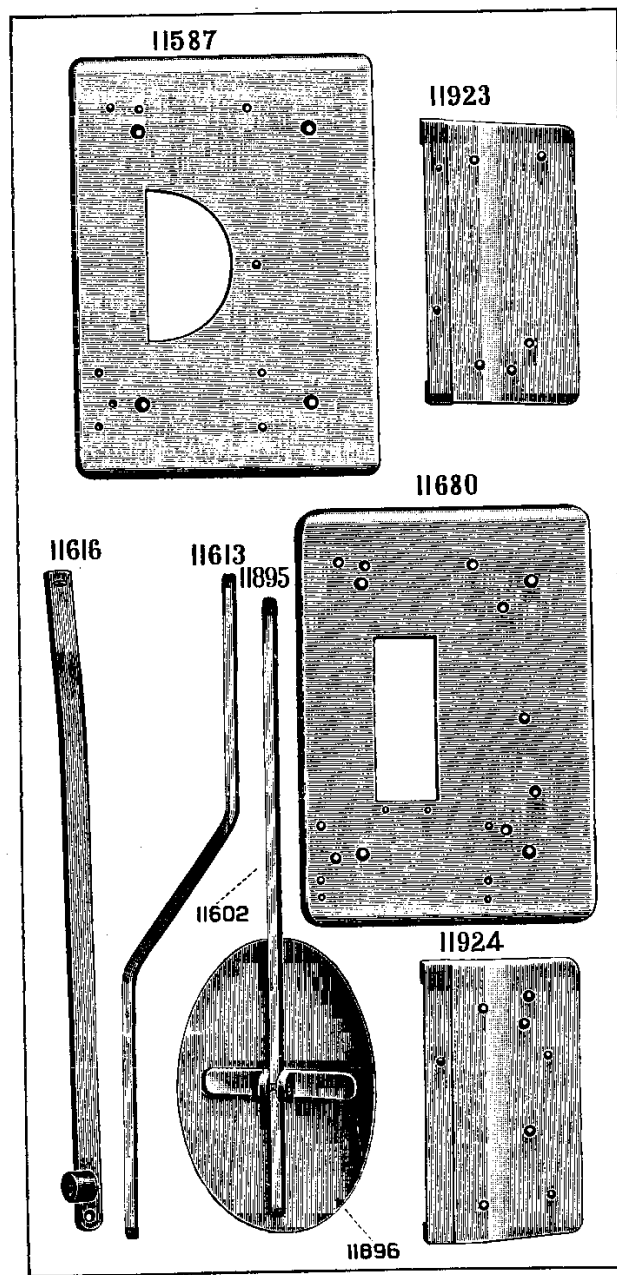

PLATE 841—ONE-HALF SIZE

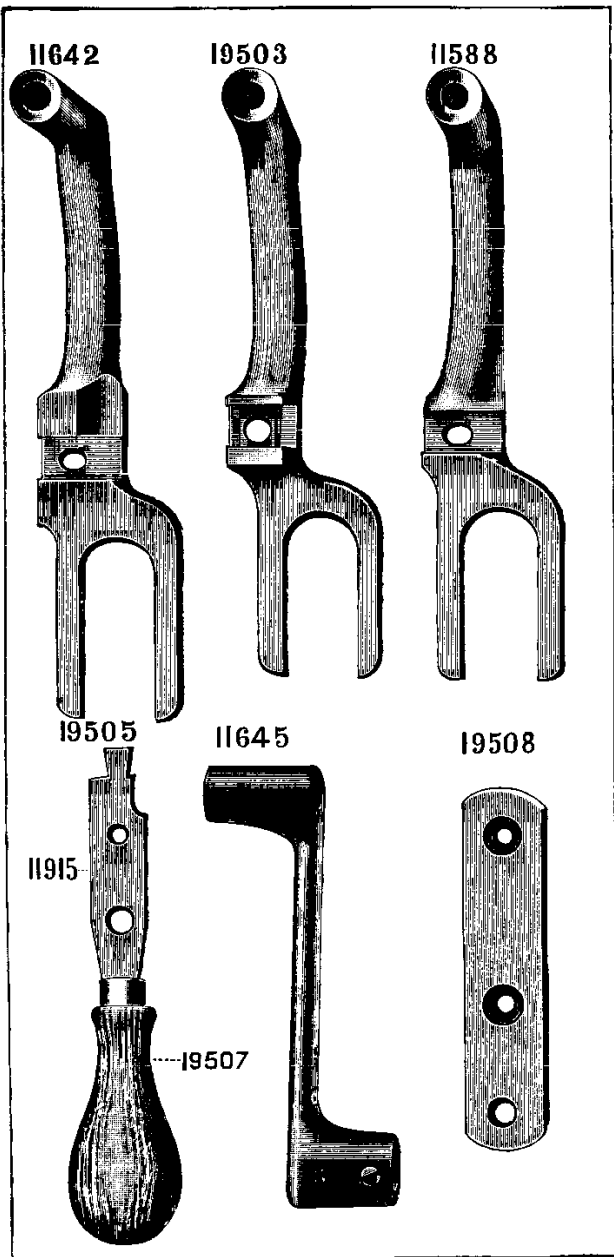

PLATE 842—ONE-HALF SIZE

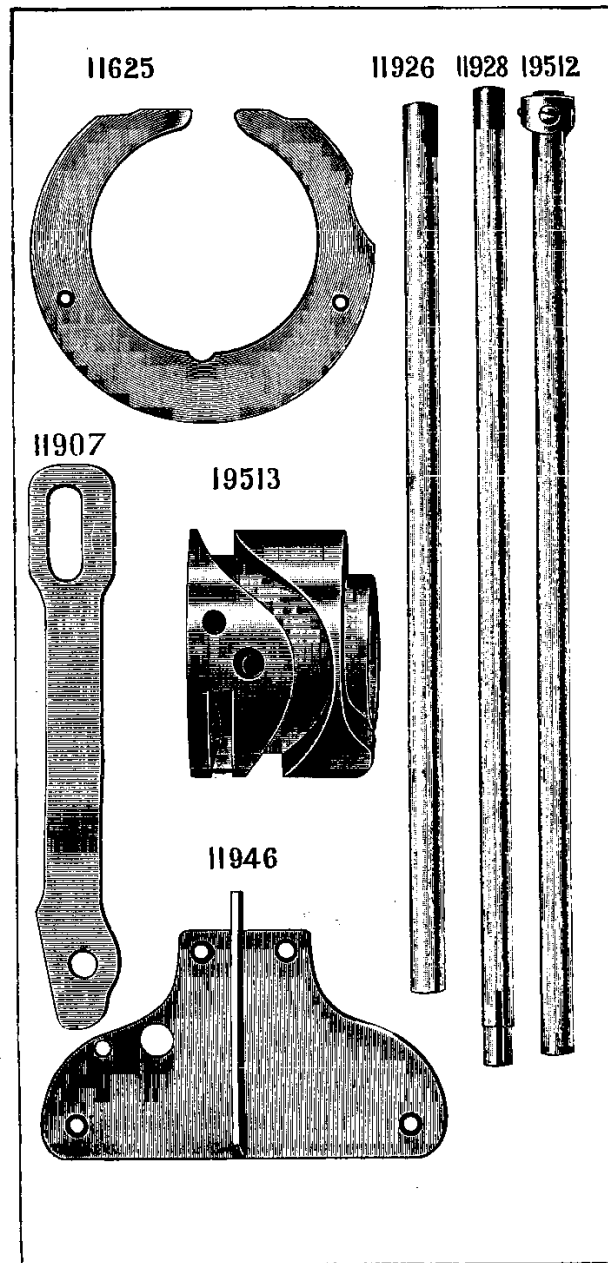

PLATE 843—ONE-HALF SIZE

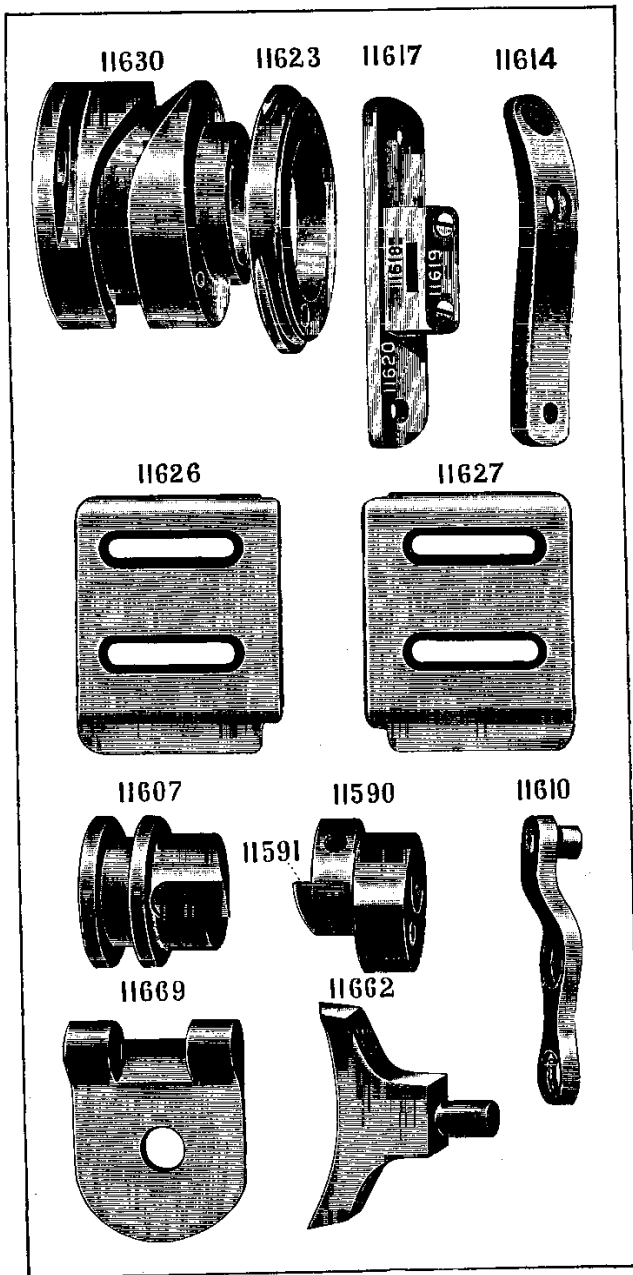
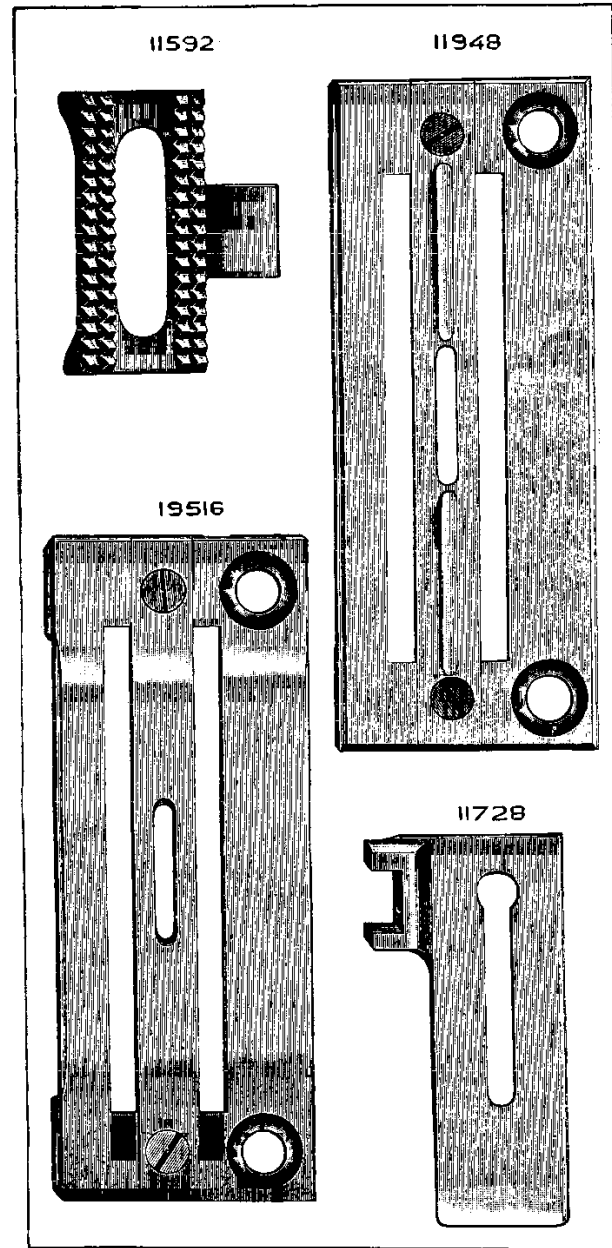

PLATE 844—FULL SIZE



From the library of: Diamond Needle Corp

PLATE 845—ONE-HALF SIZE

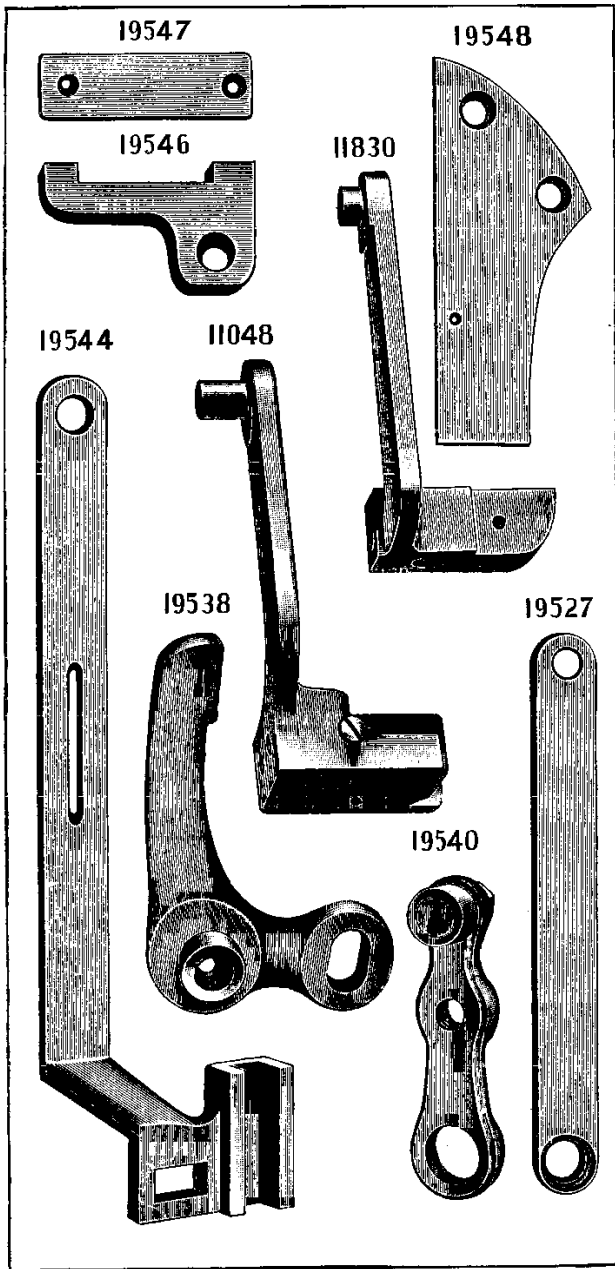

PLATE 846—ONE-HALF SIZE

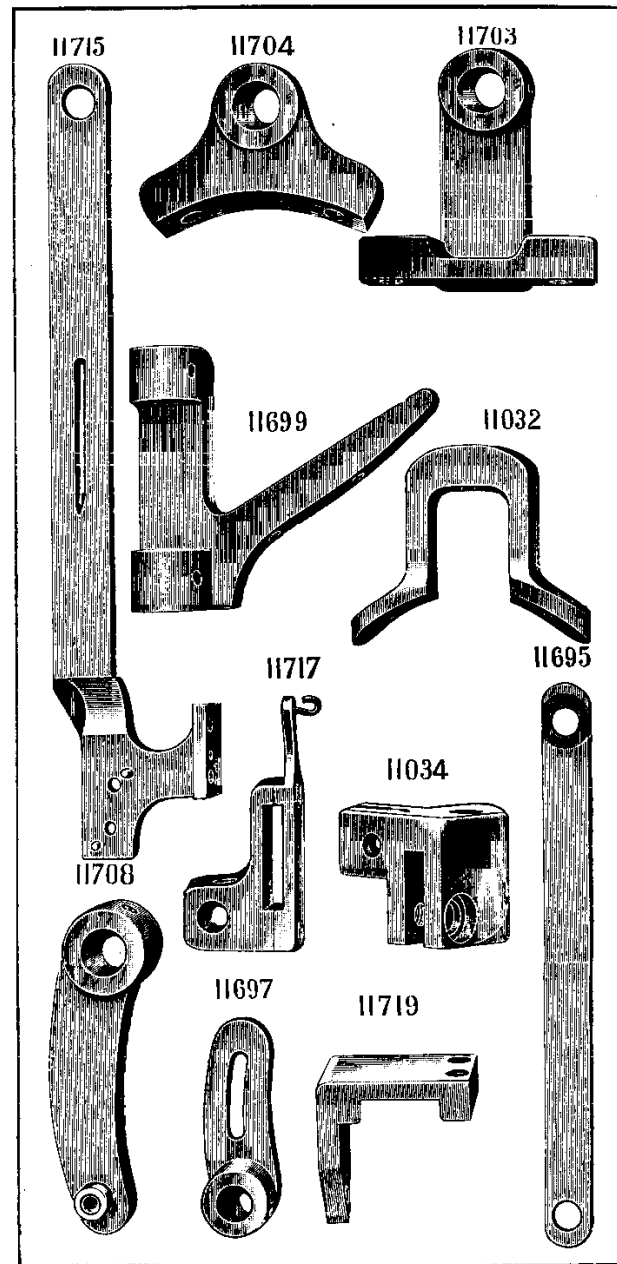

PLATE 847—ONE-HALF SIZE

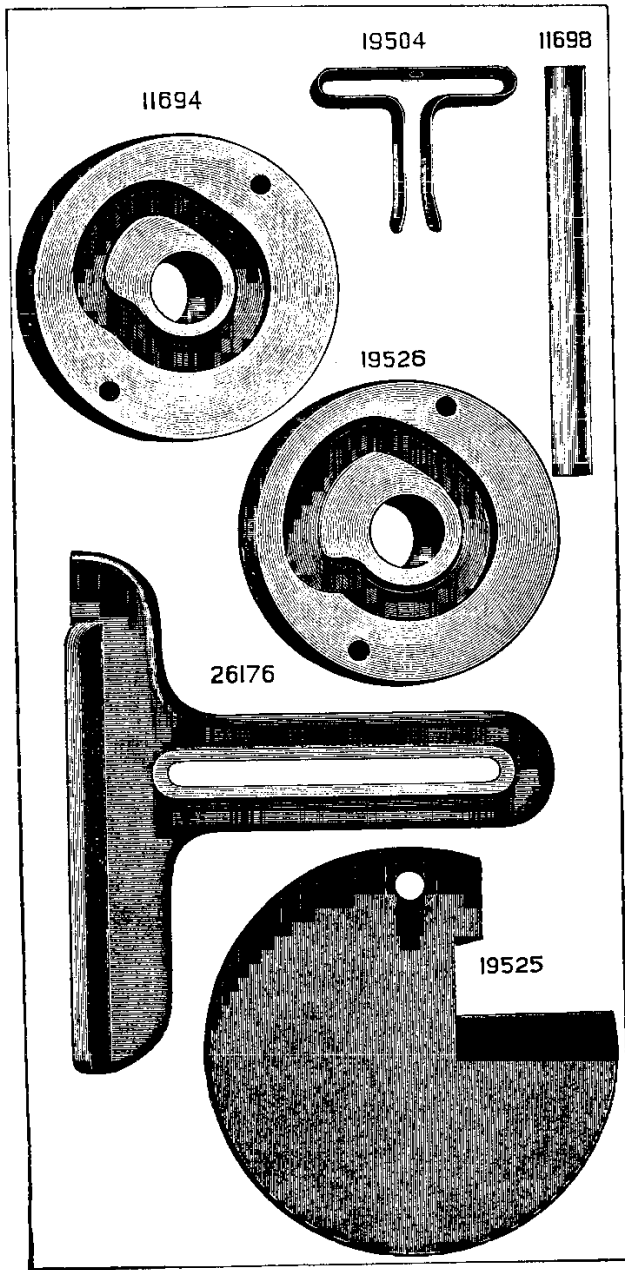

PLATE 848—ONE-HALF SIZE

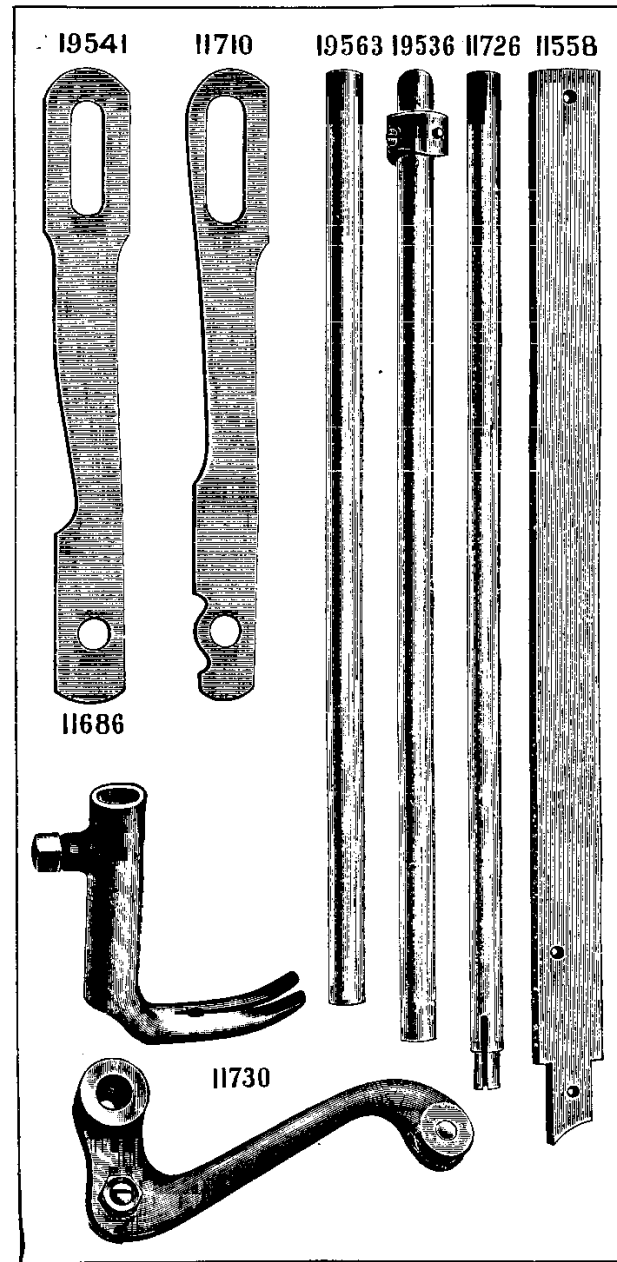

PLATE 849—FULL SIZE

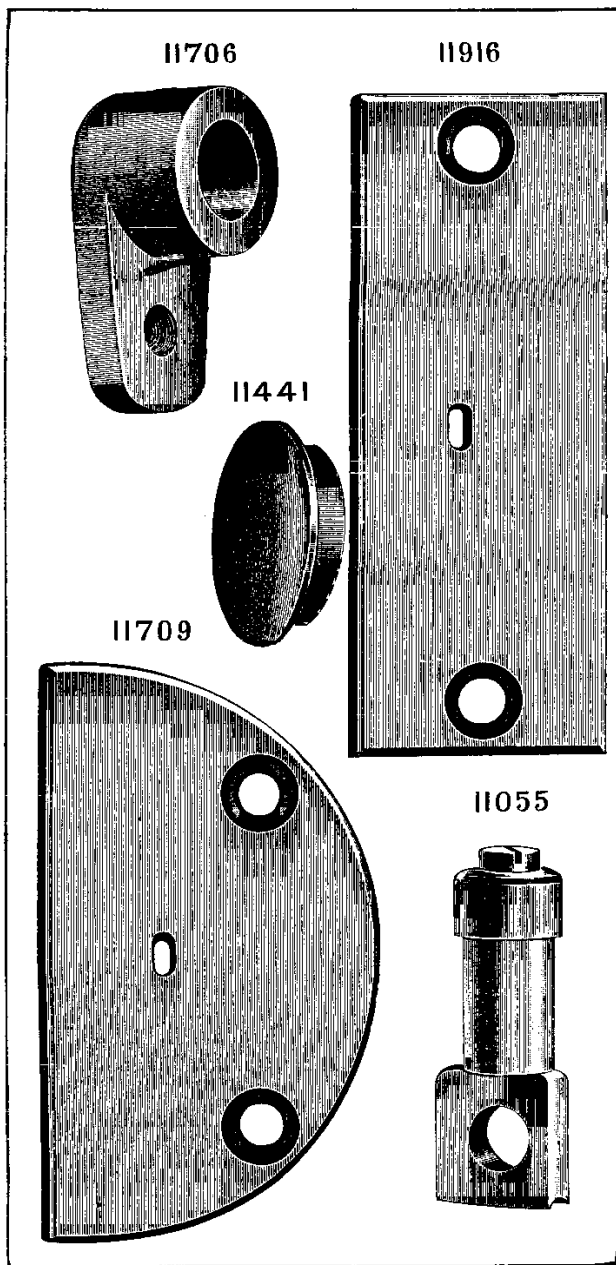

PLATE 850—ONE-HALF SIZE

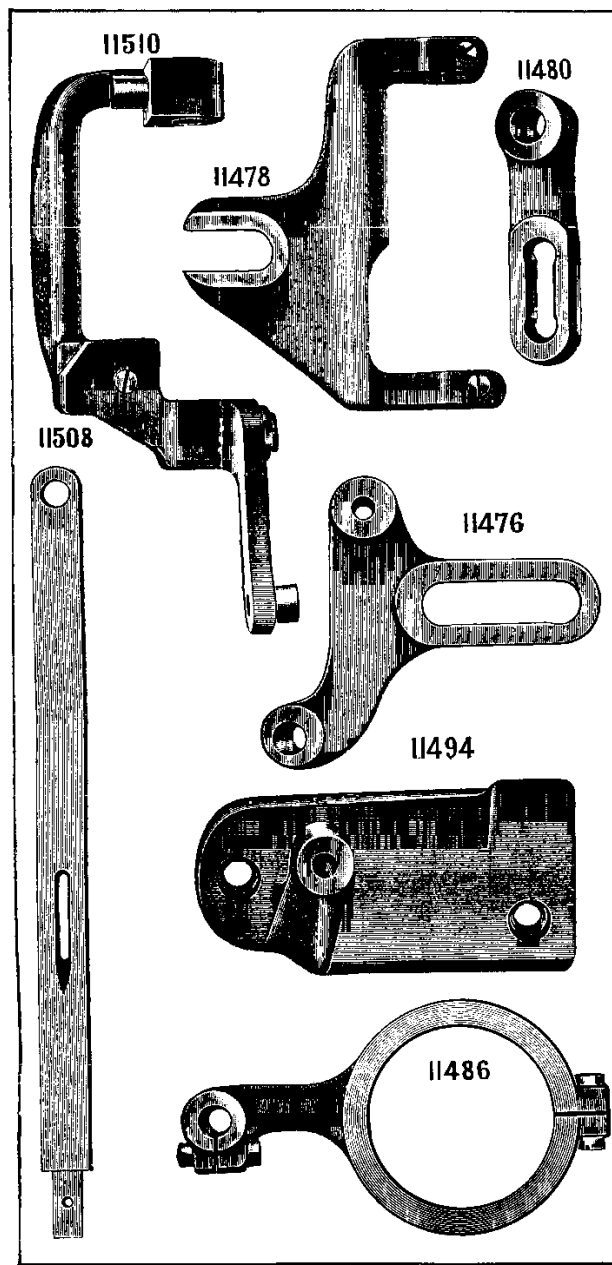

PLATE 851—ONE-HALF SIZE

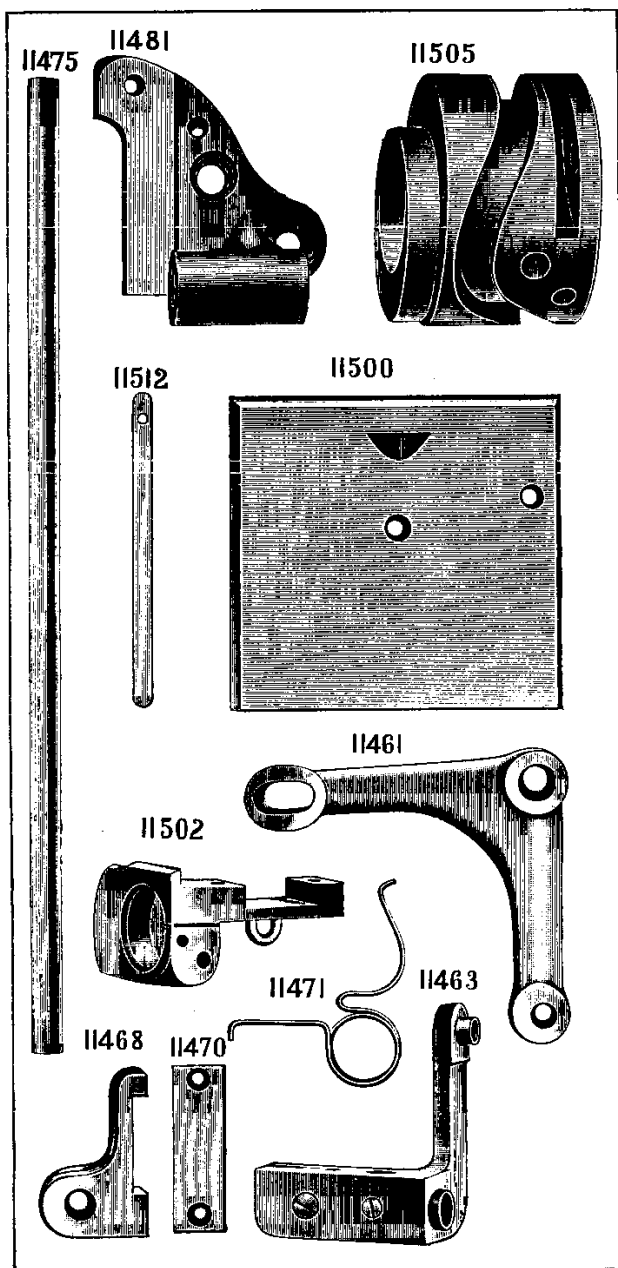

PLATE 852—FULL SIZE

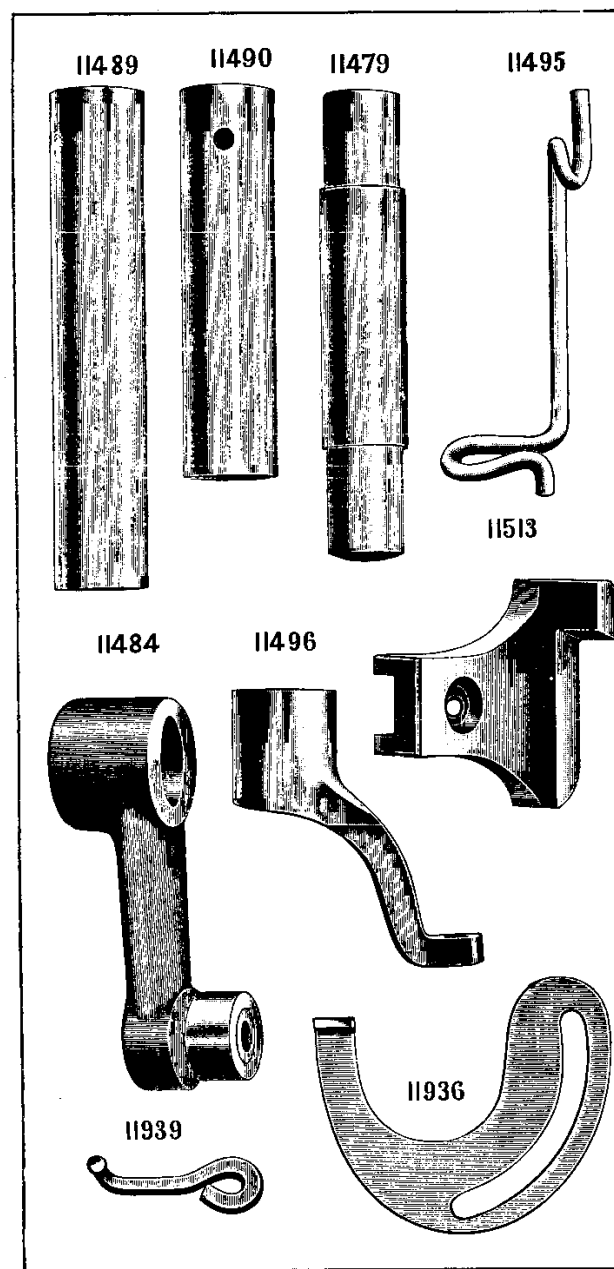

PLATE 853—FULL SIZE

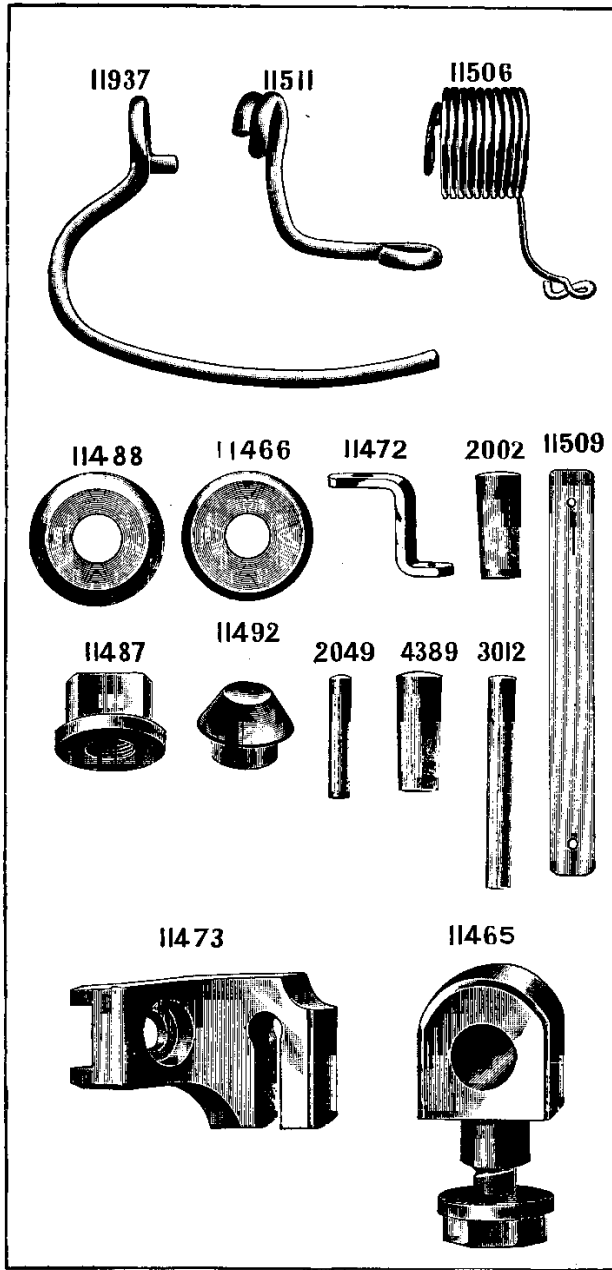

PLATE 854—ONE-FOURTH SIZE

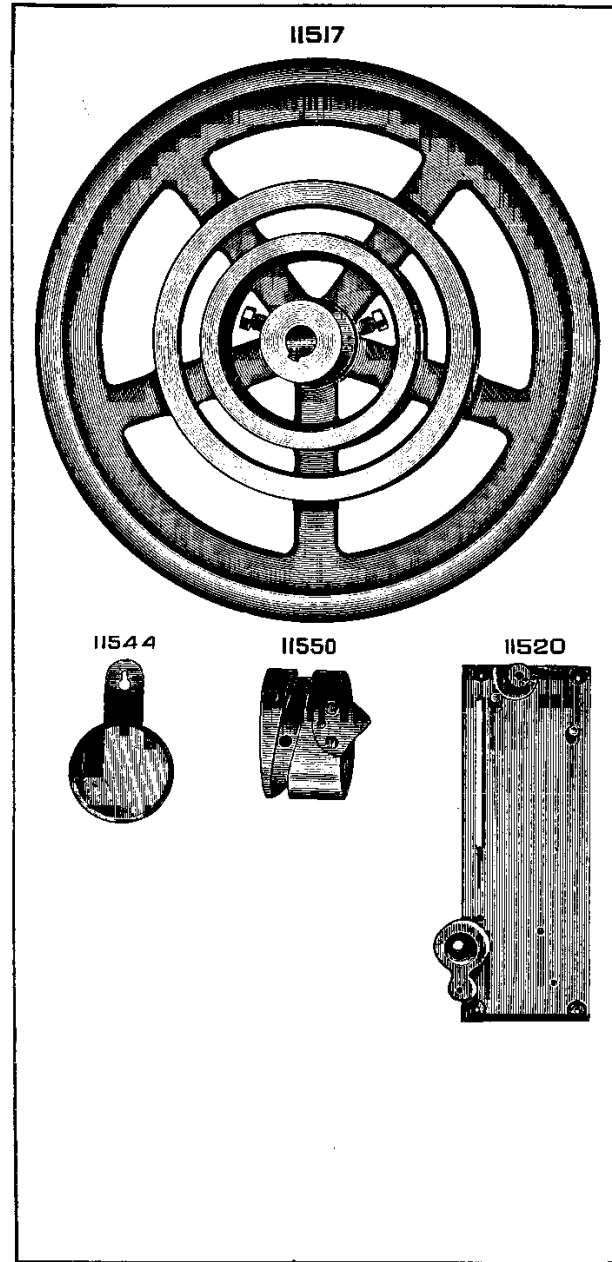

PLATE 855—ONE-FOURTH SIZE

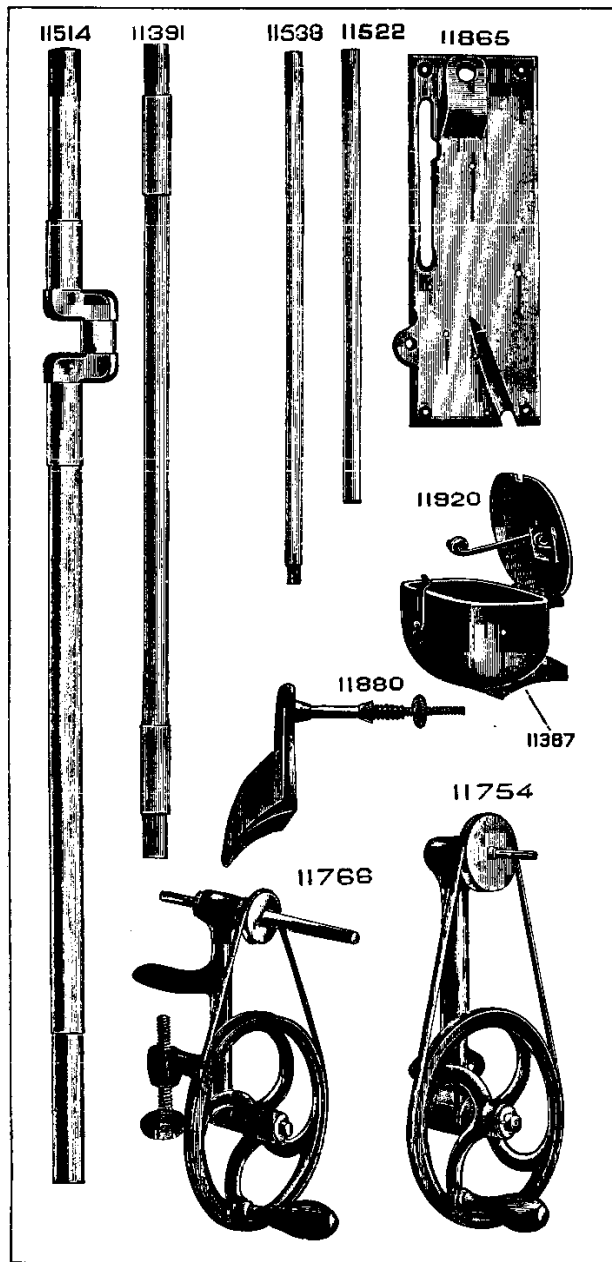

PLATE 856—ONE-HALF SIZE

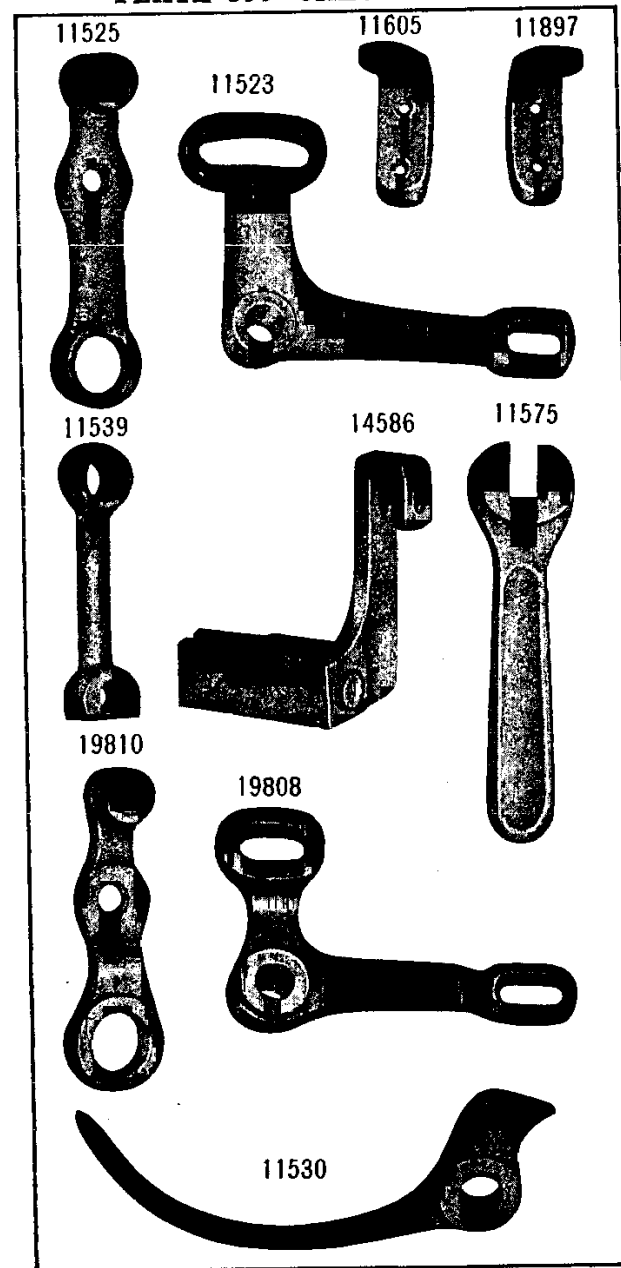

PLATE 857—ONE-HALF SIZE

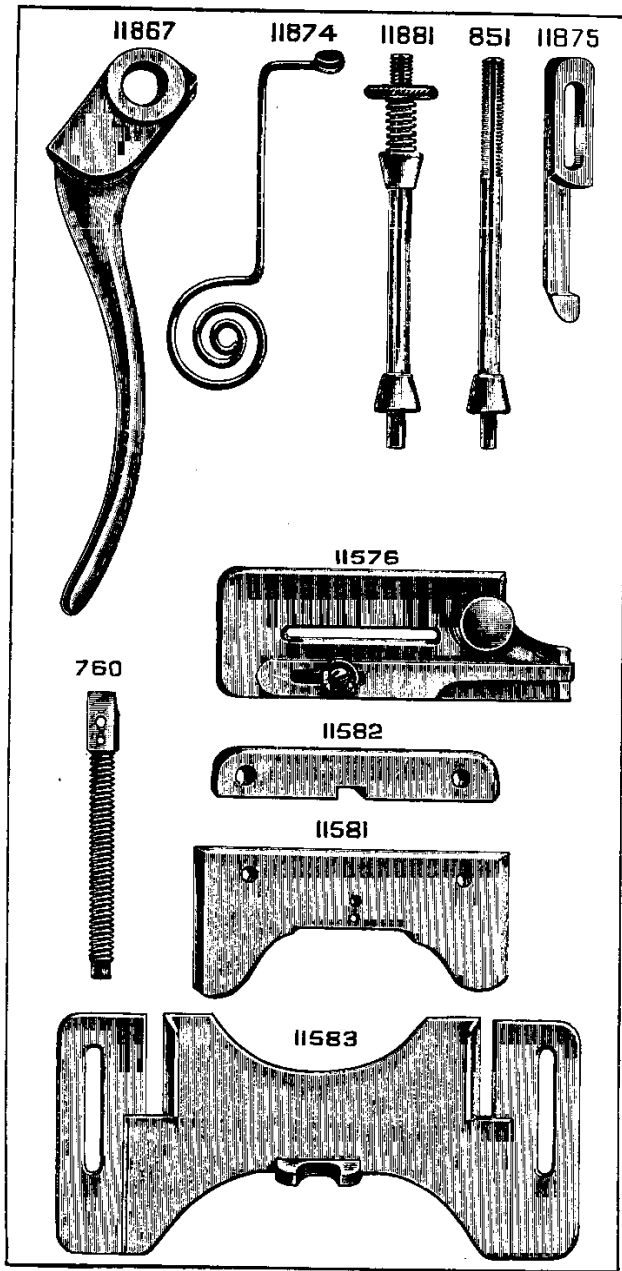
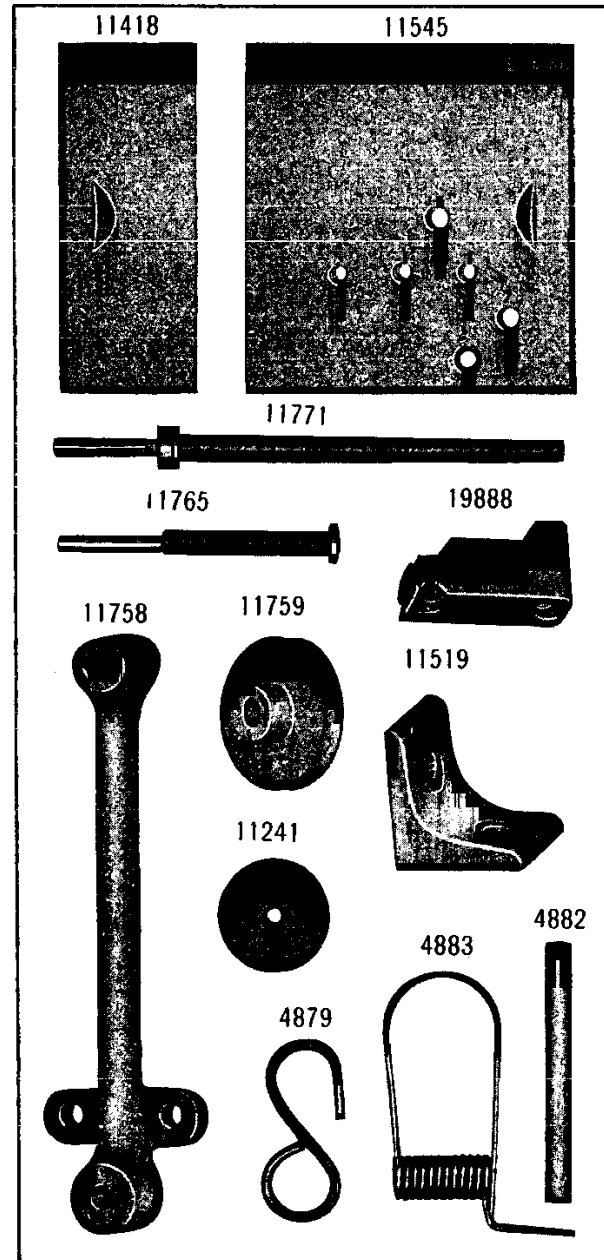

PLATE 858—ONE-HALF SIZE



From the library of: Diamond Needle Corp

PLATE 859—FULL SIZE

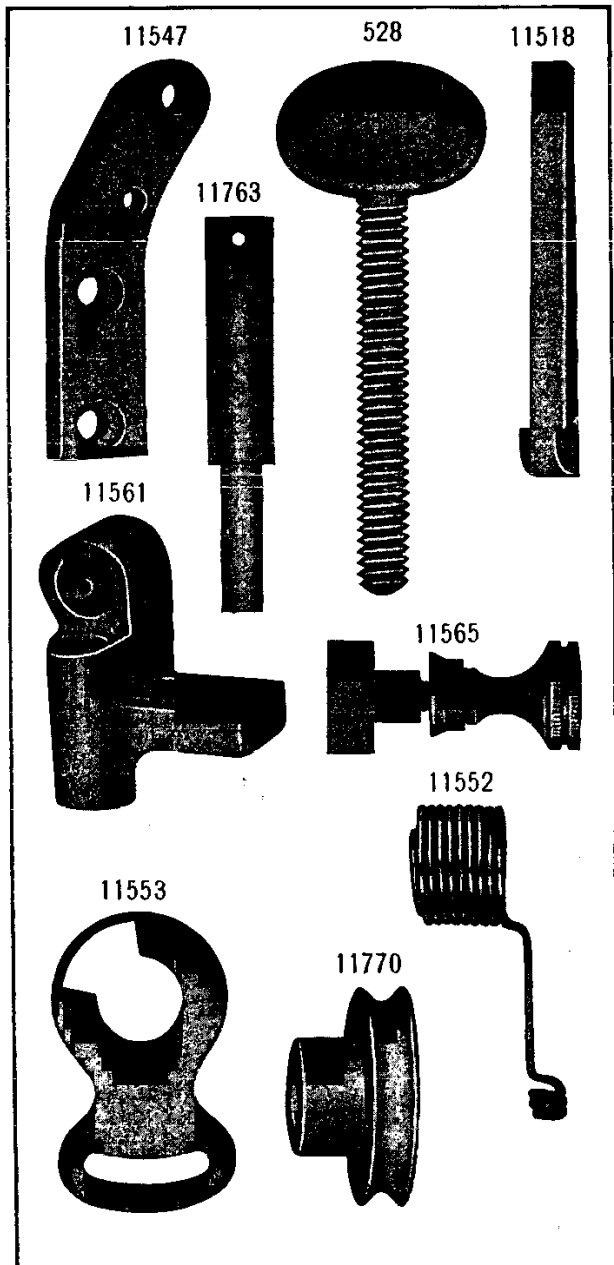
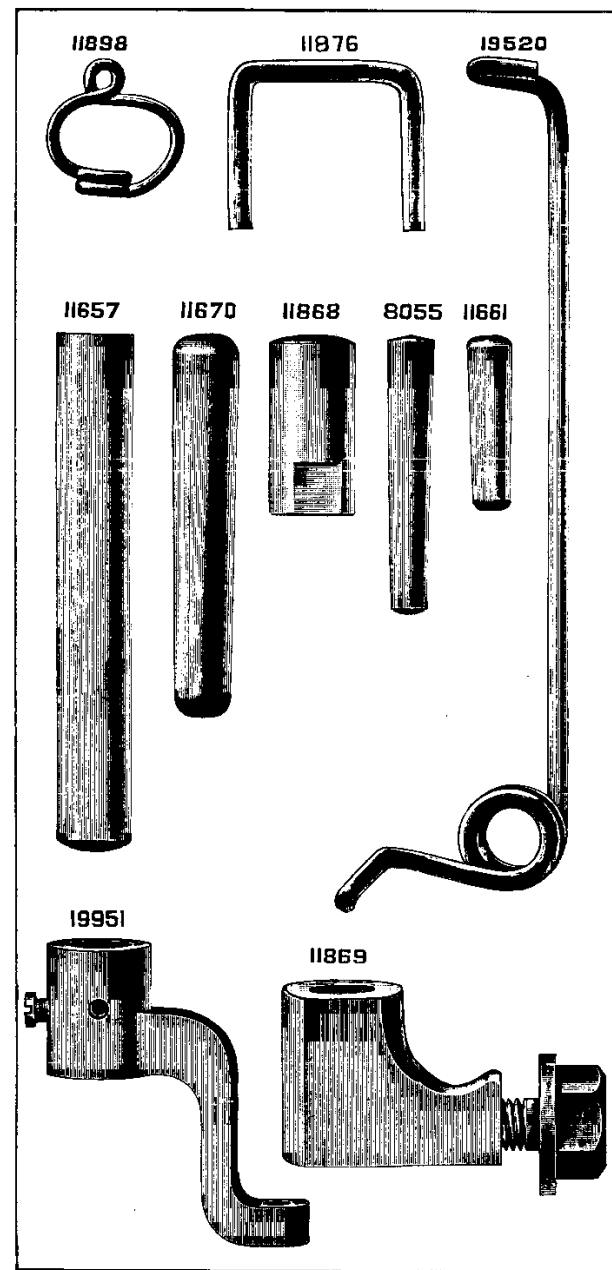

PLATE 860—FULL SIZE



From the library of: Diamond Needle Corp

PLATE 861—FULL SIZE

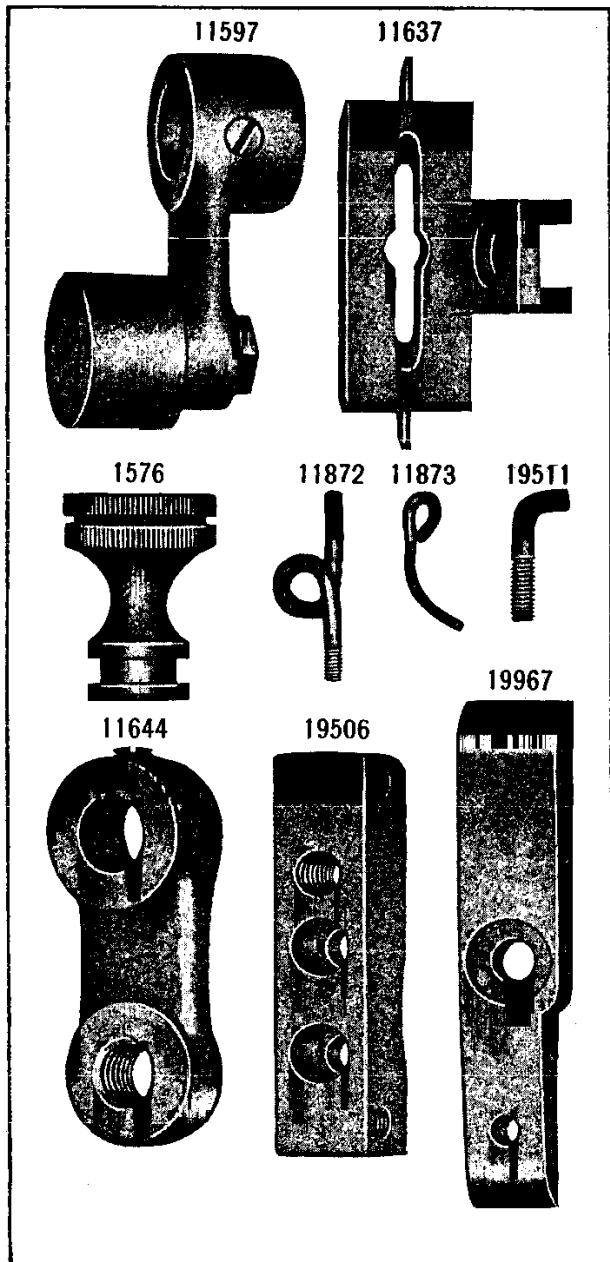
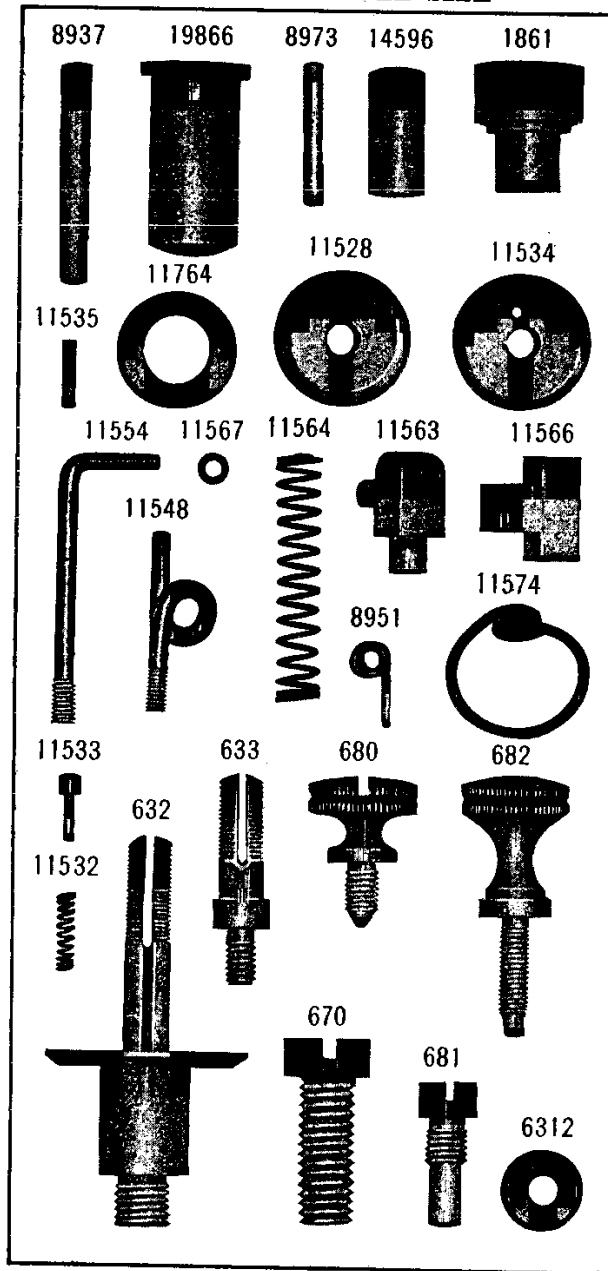

PLATE 862—FULL SIZE



From the library of: Diamond Needle Corp

PLATE 863—ONE-FOURTH SIZE

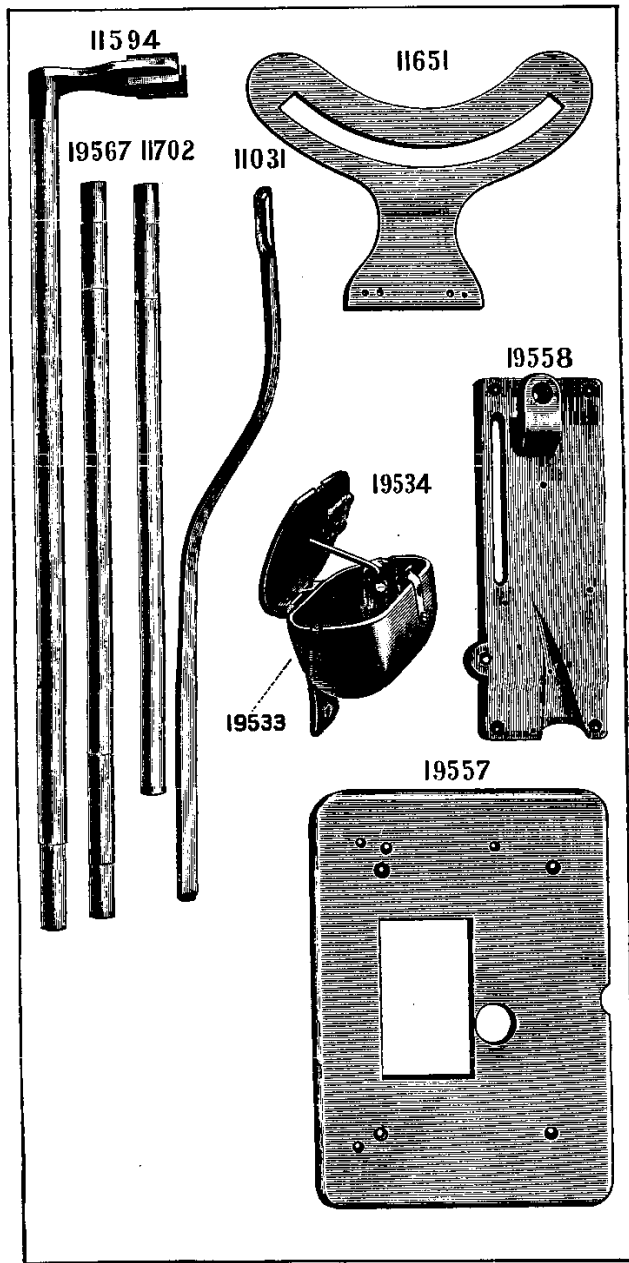

PLATE 864—ONE-HALF SIZE

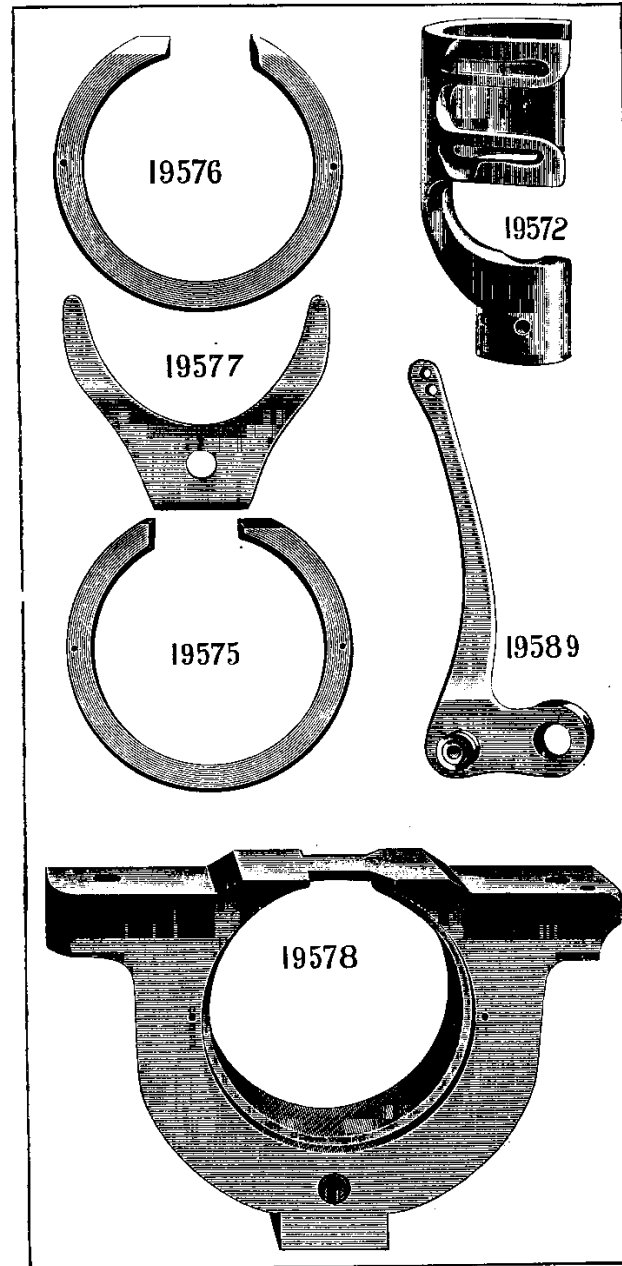

PLATE 865—FULL SIZE

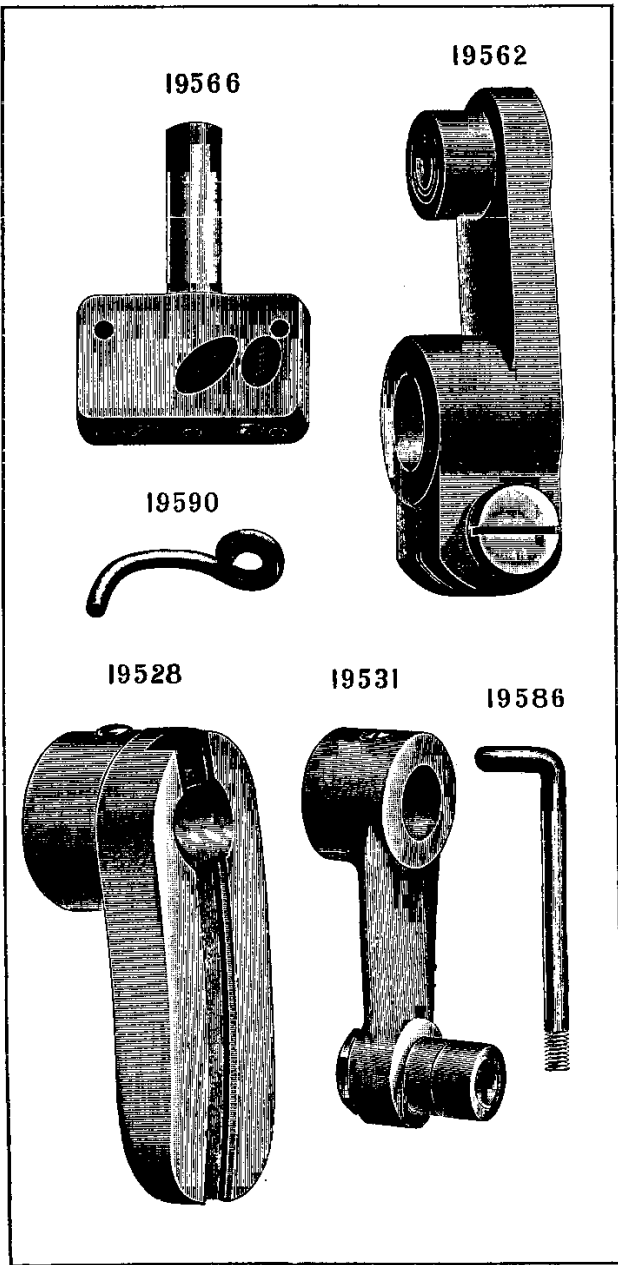

PLATE 868—FULL SIZE

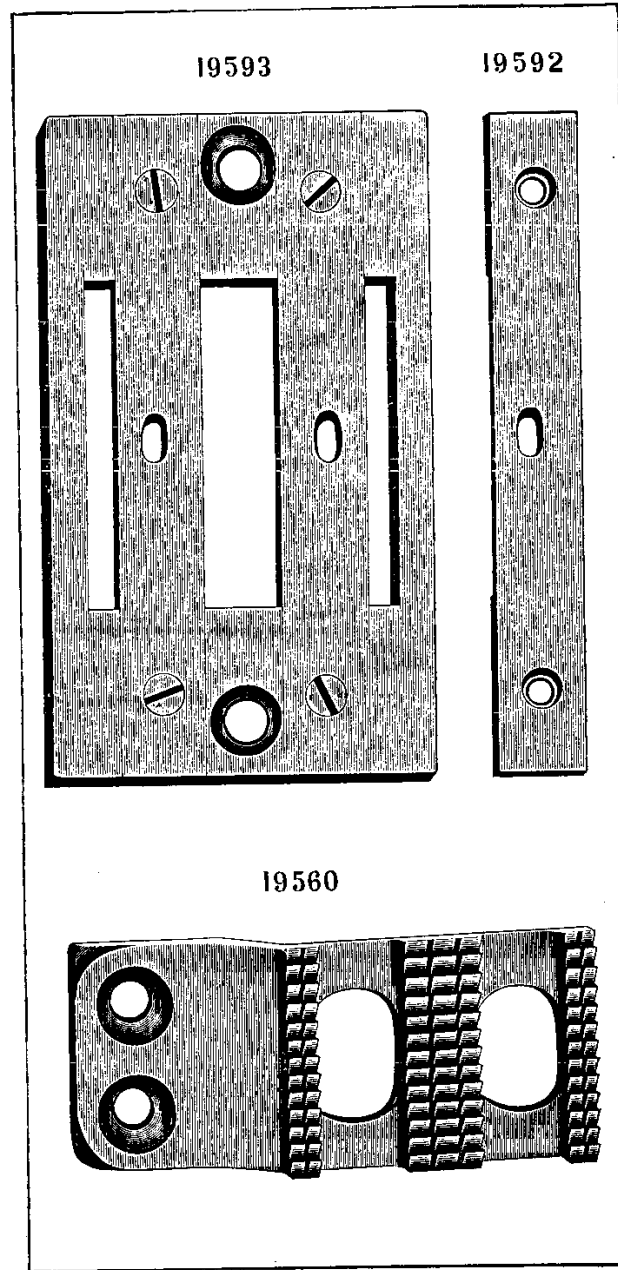

PLATE 869—FULL SIZE

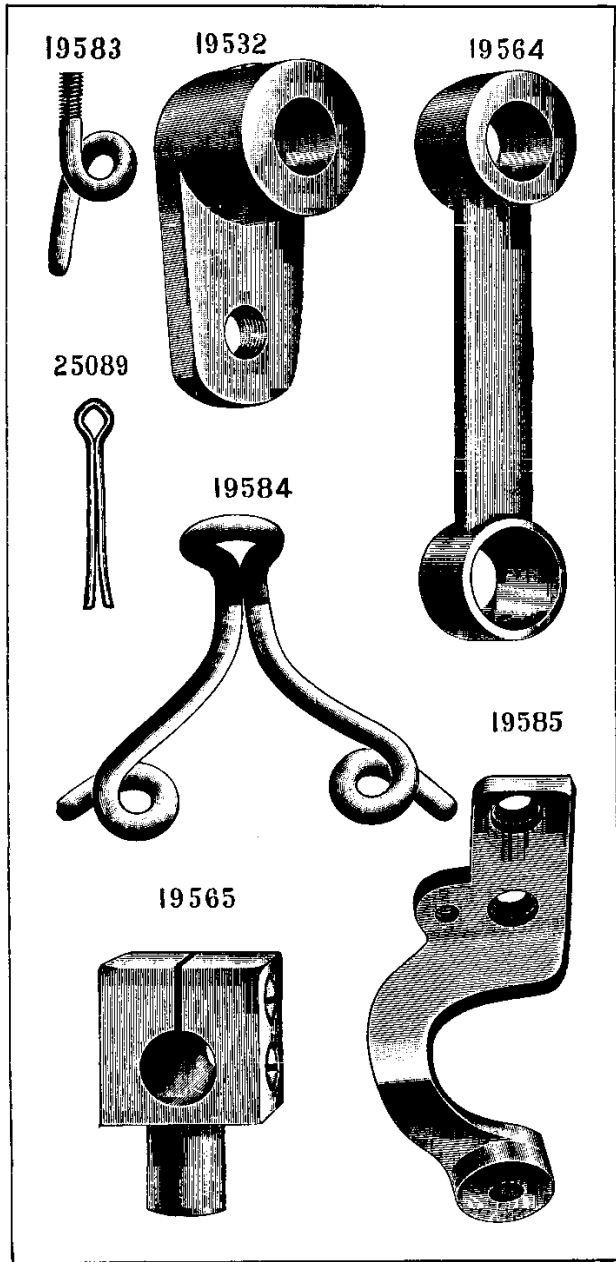

PLATE 873—ONE-HALF SIZE

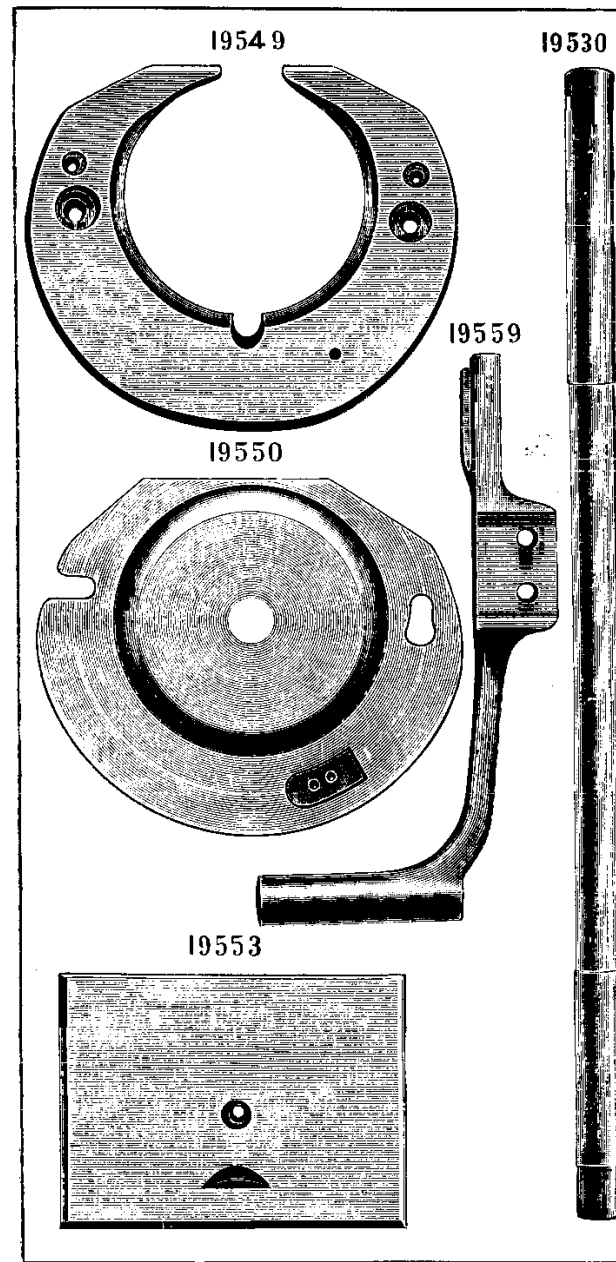

PLATE 874—FULL SIZE

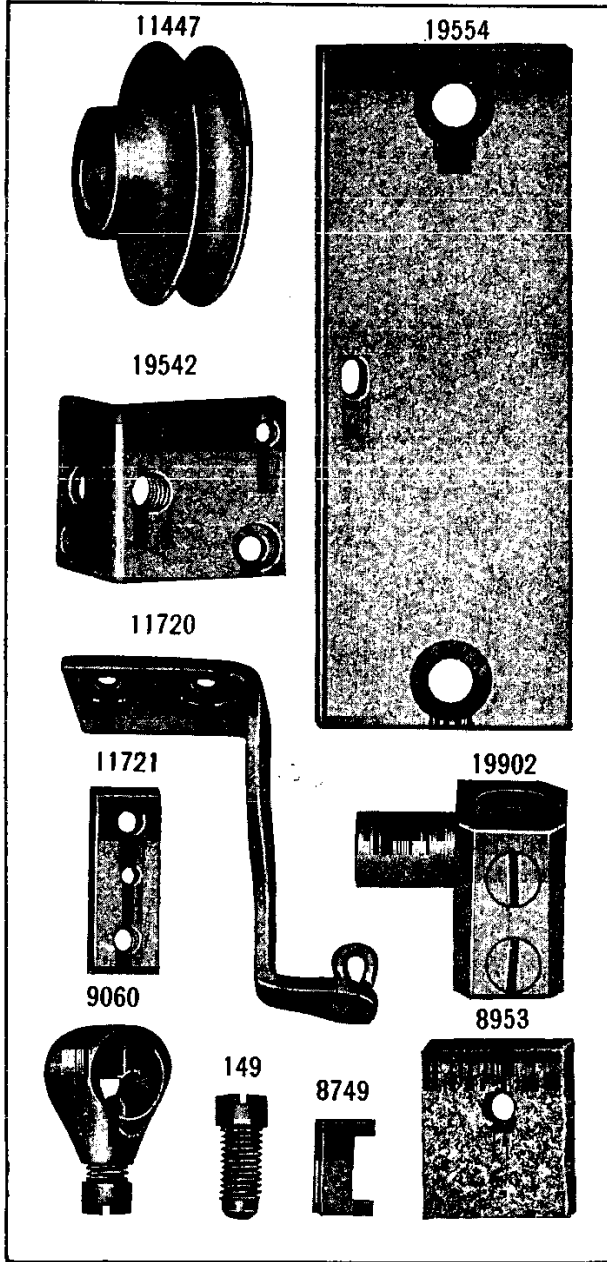

PLATE 875—FULL SIZE

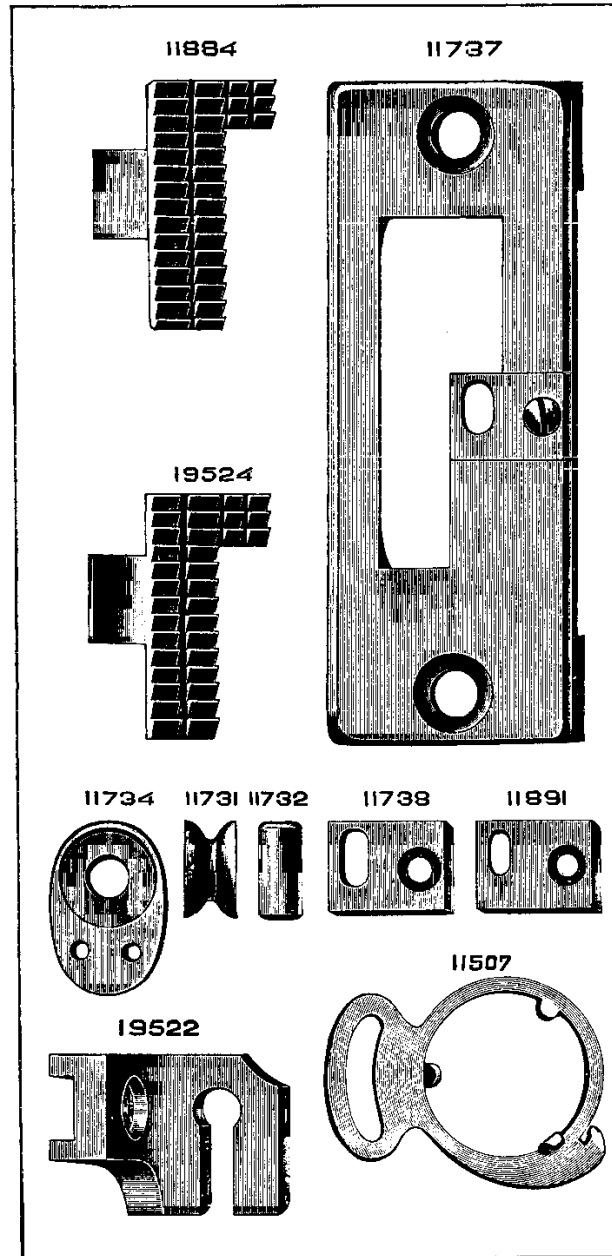

PLATE 876—ONE-HALF SIZE

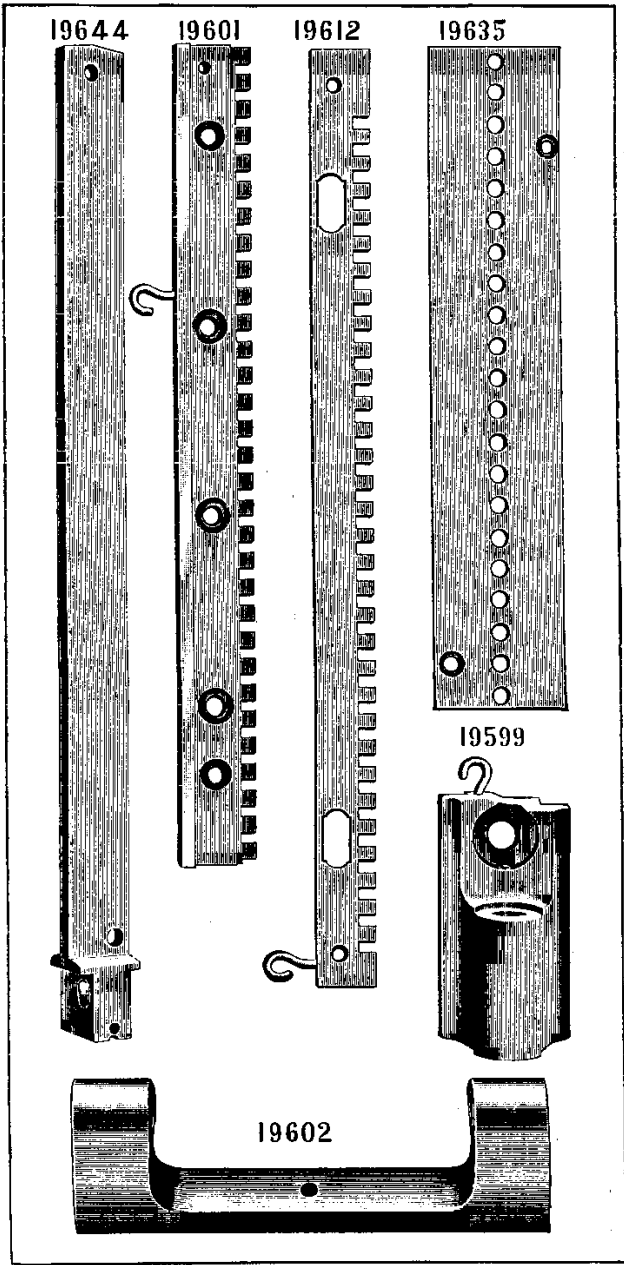

PLATE 877—ONE-HALF SIZE

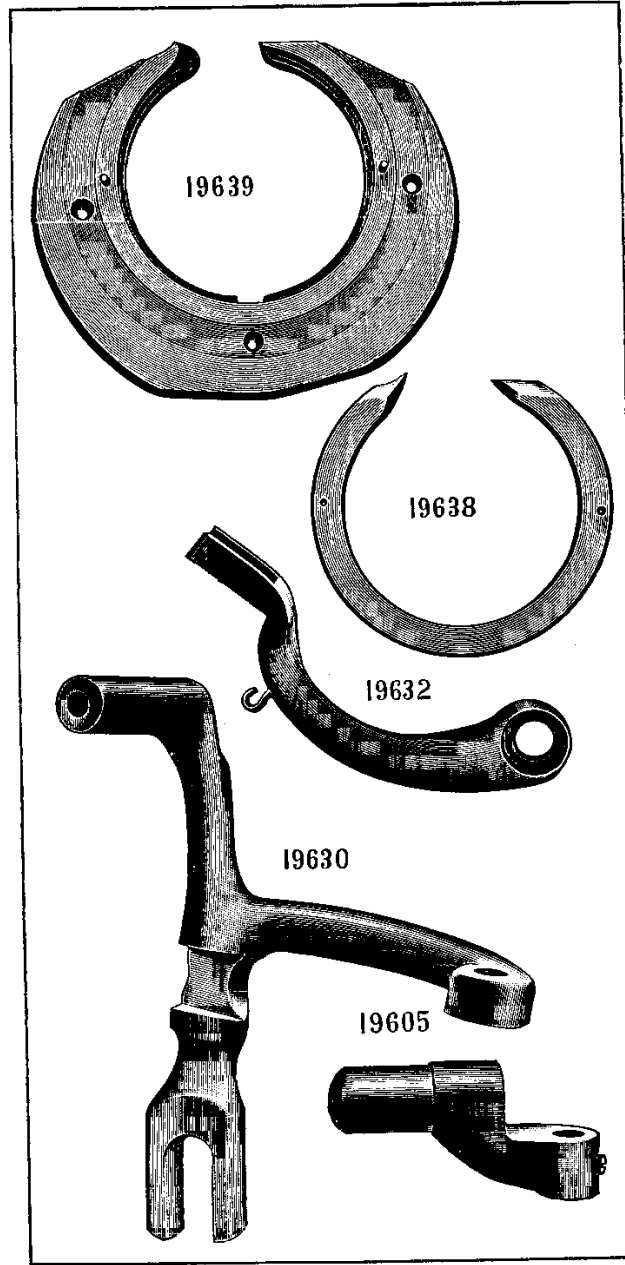

PLATE 878—ONE-HALF SIZE

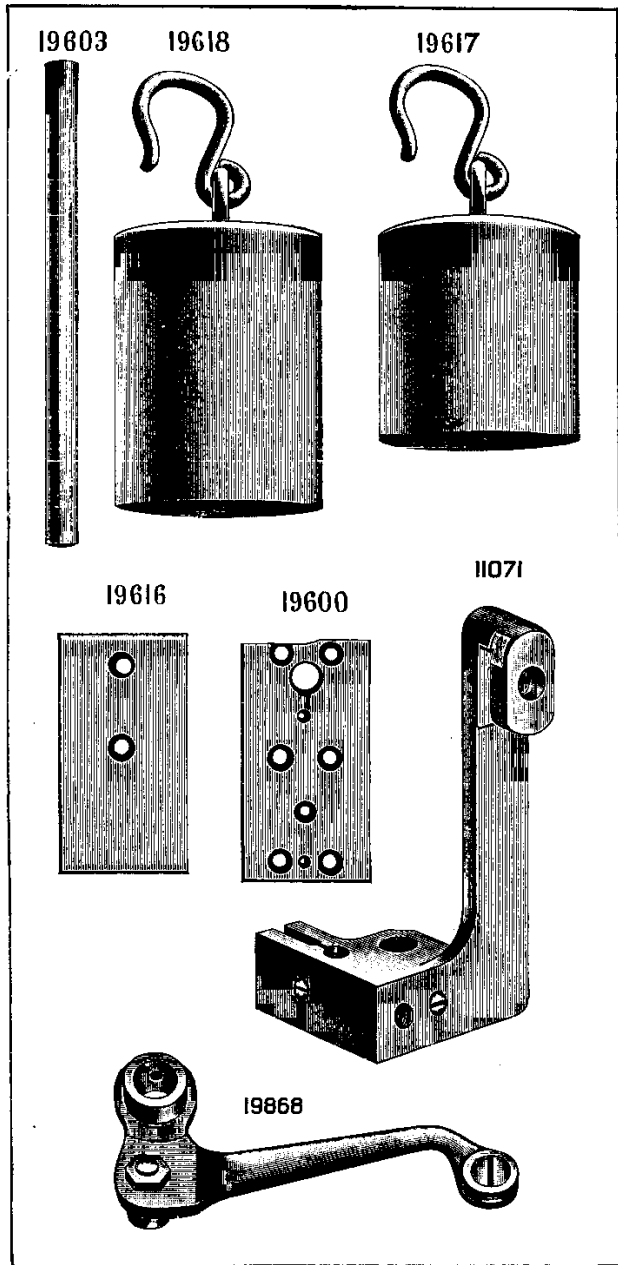

PLATE 879—FULL SIZE

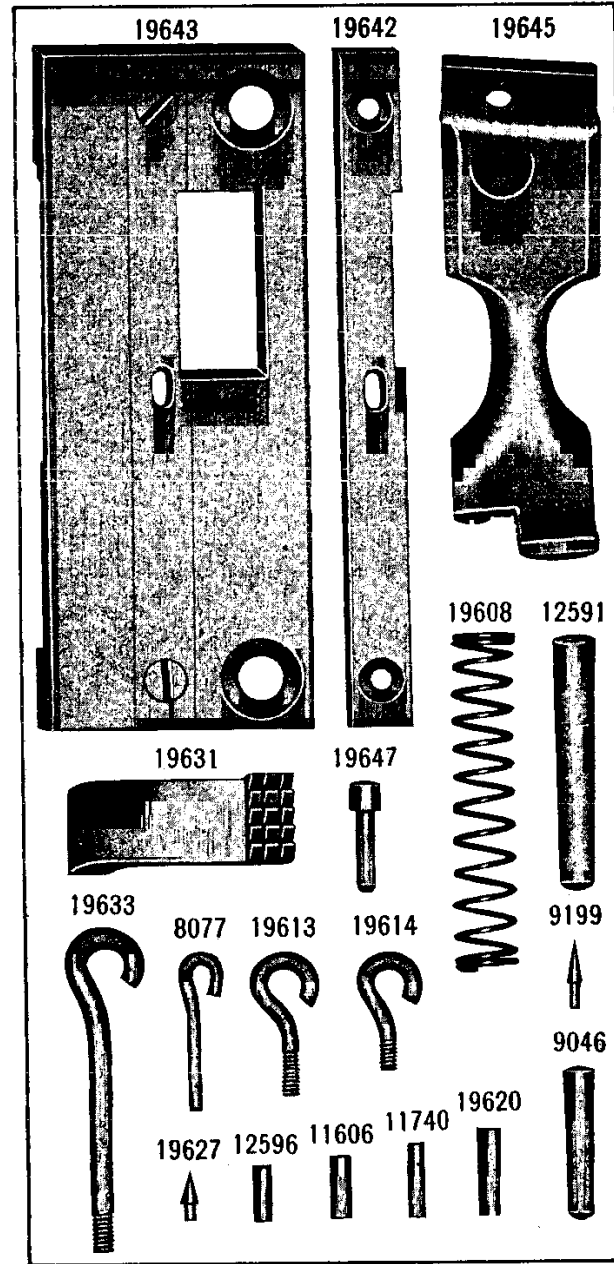

PLATE 880—FULL SIZE

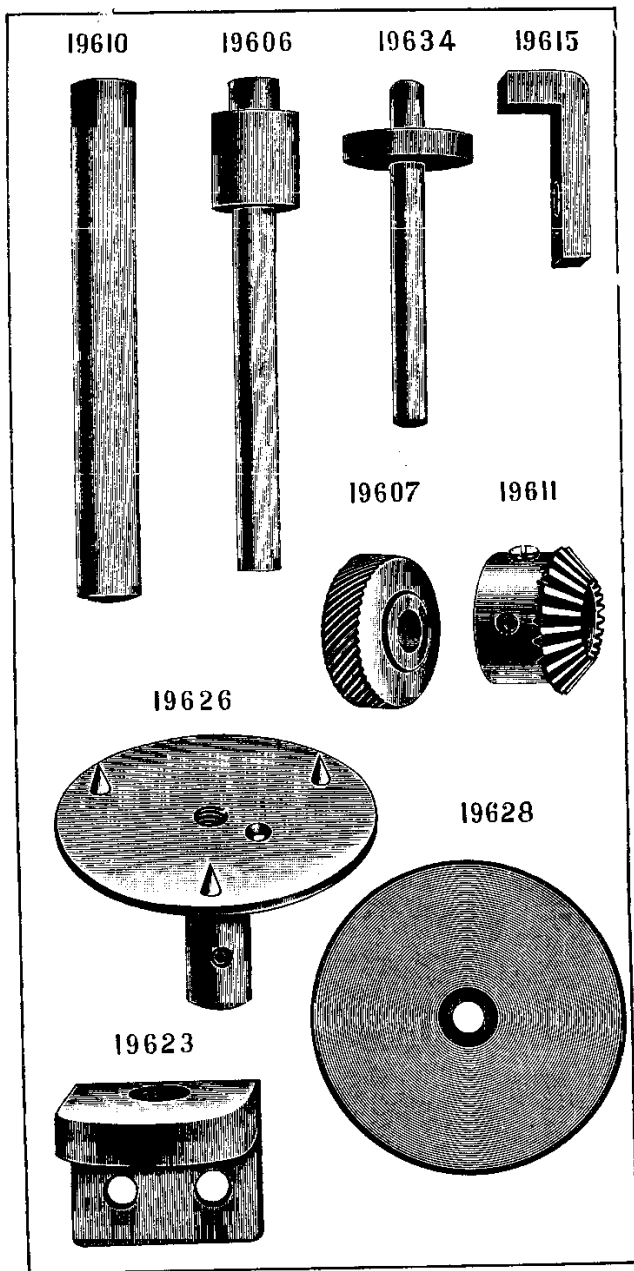
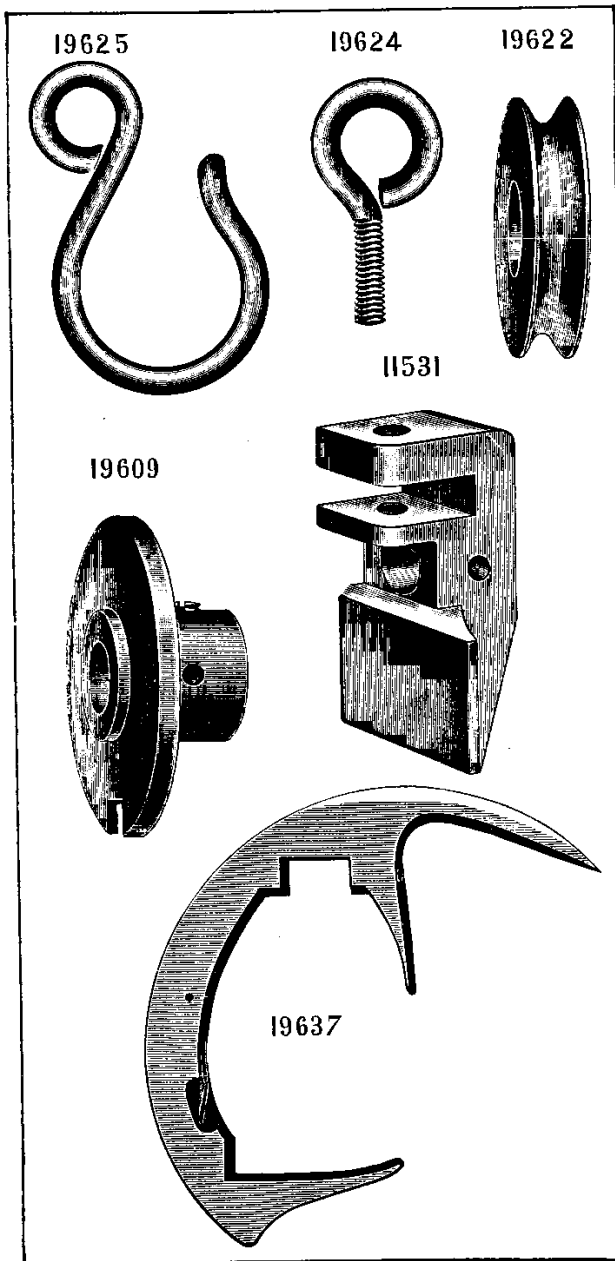

PLATE 881—FULL SIZE



From the library of: Diamond Needle Corp

PLATE 882—ONE-HALF SIZE

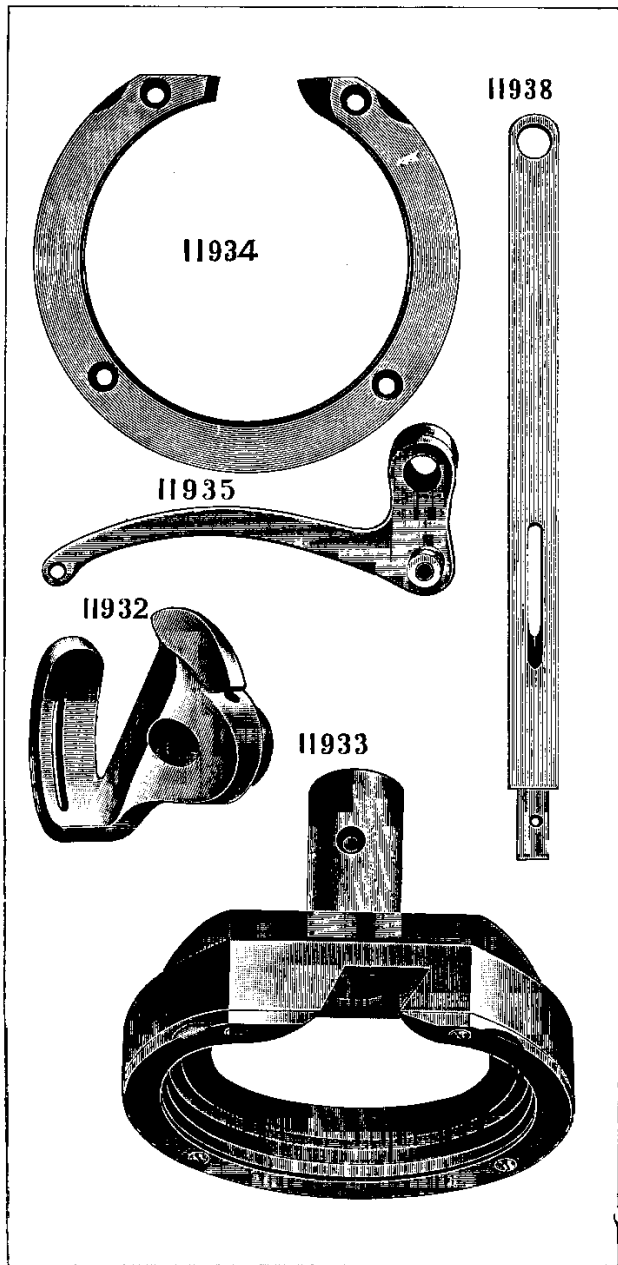

PLATE 883—FULL SIZE

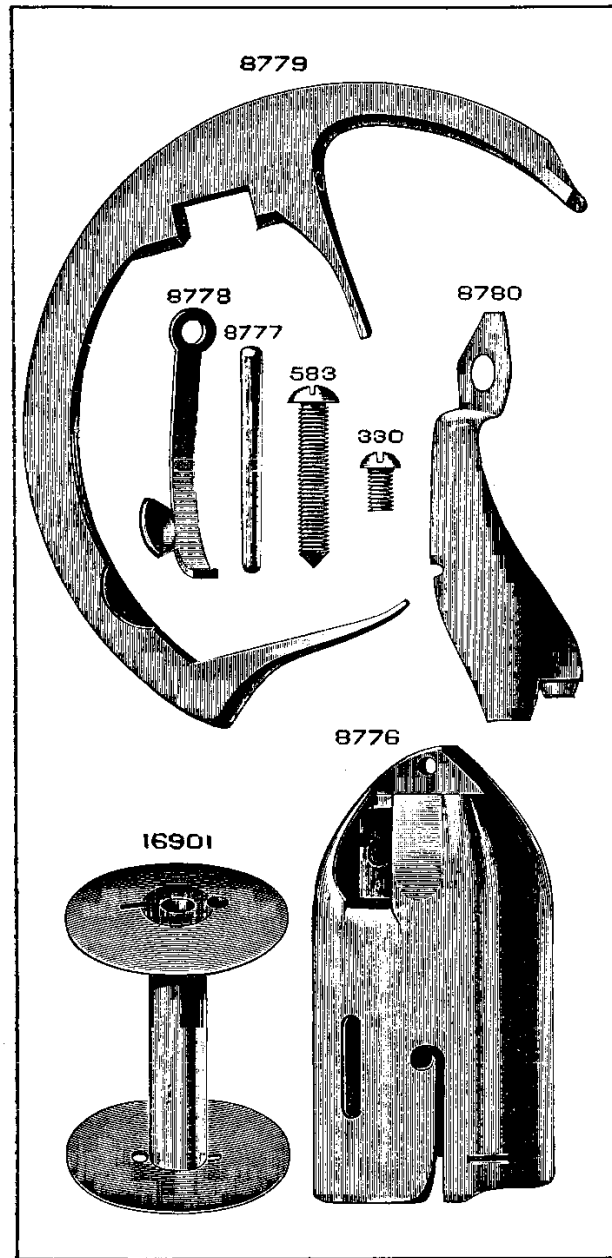

PLATE 884—FULL SIZE

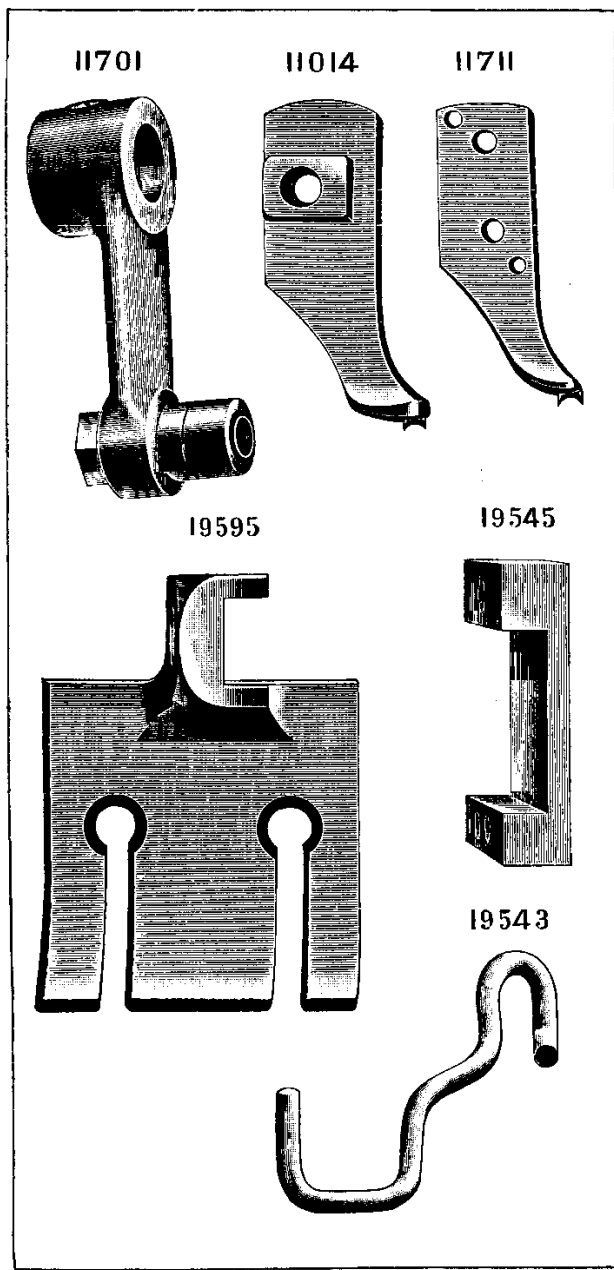
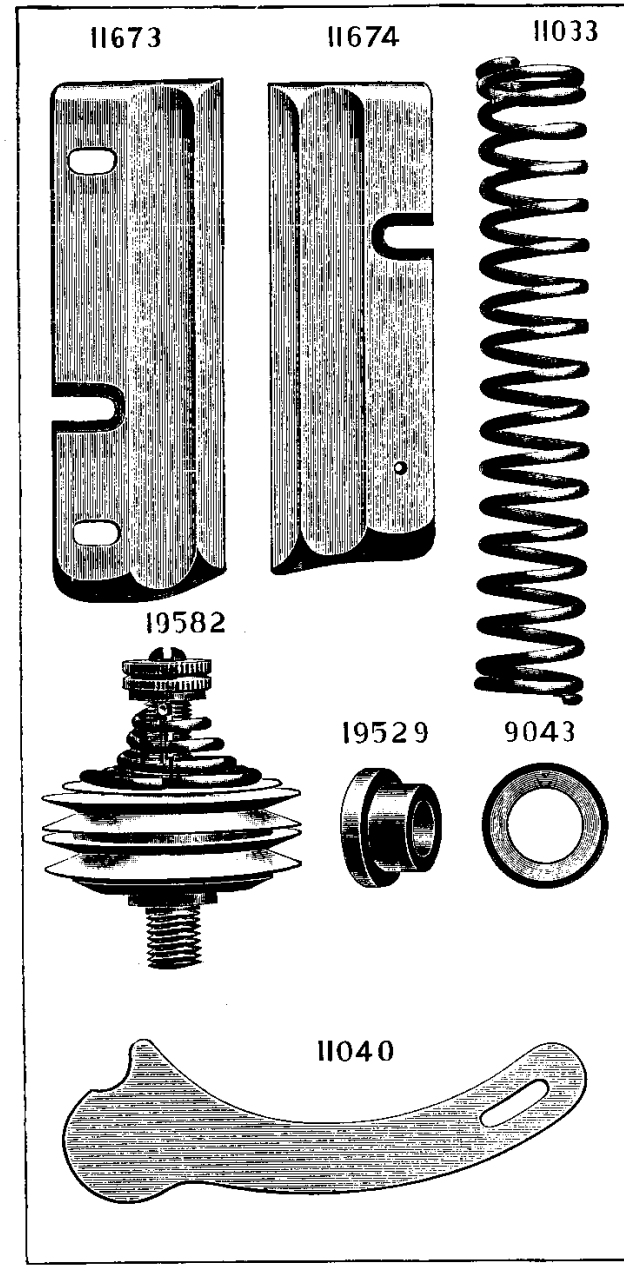

PLATE 885—FULL SIZE



From the library of: Diamond Needle Corp

PLATE 886—FULL SIZE

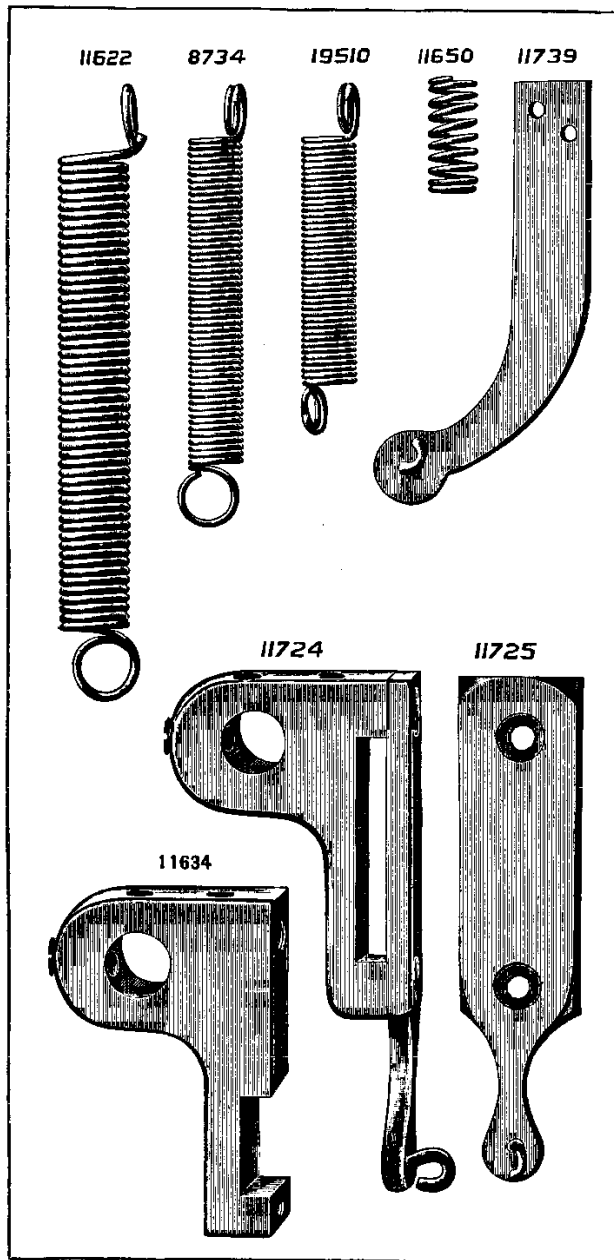

PLATE 887—FULL SIZE

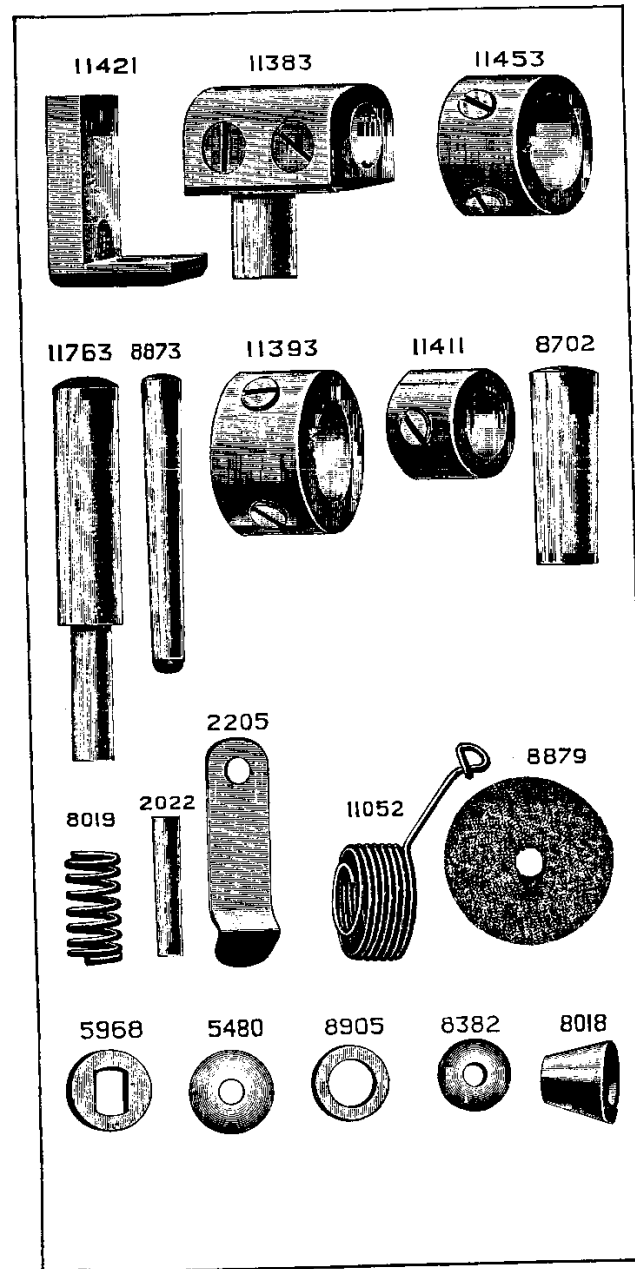

PLATE 888—FULL SIZE

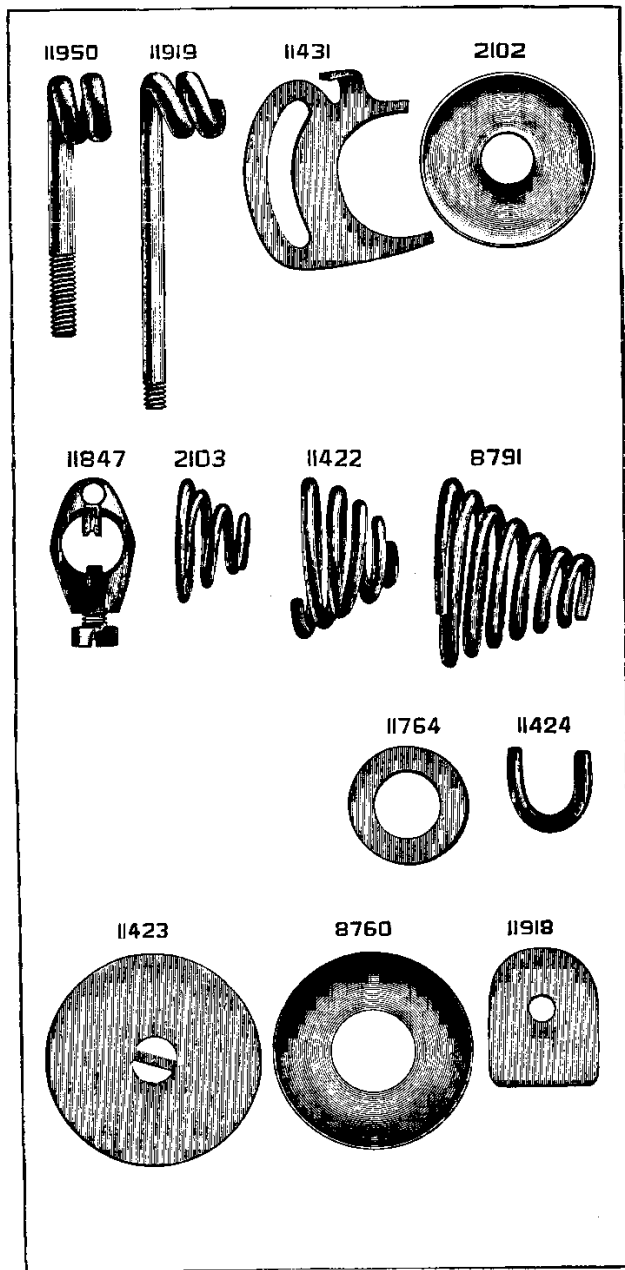

PLATE 889—FULL SIZE

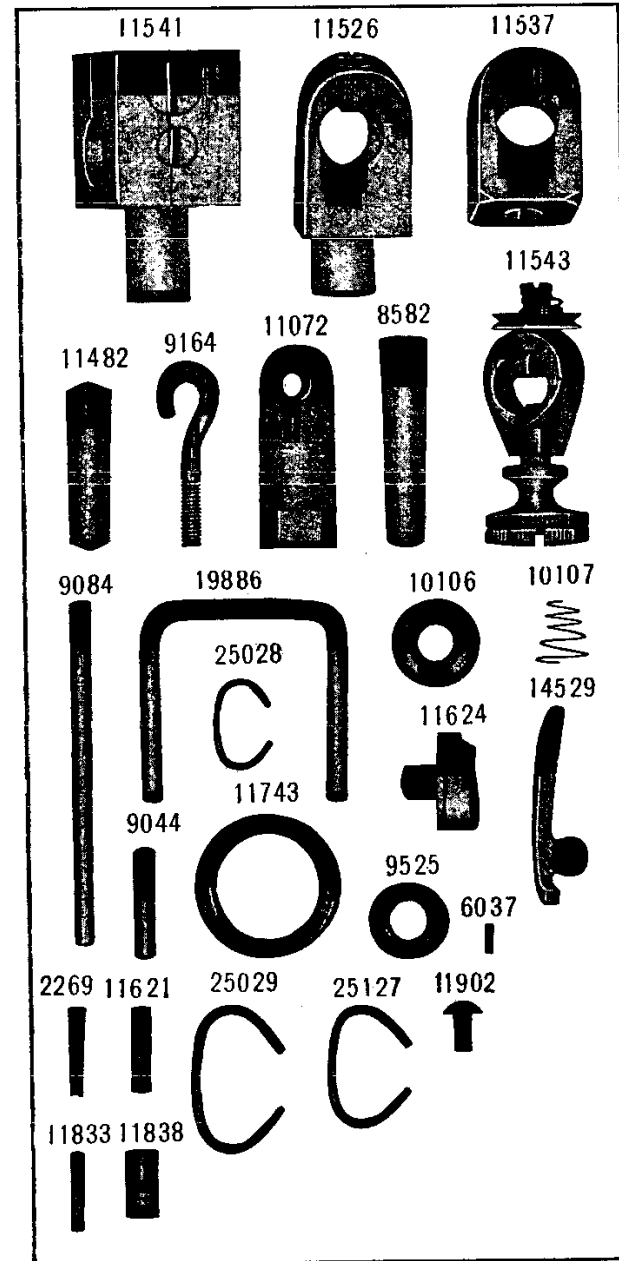

PLATE 890—FULL SIZE

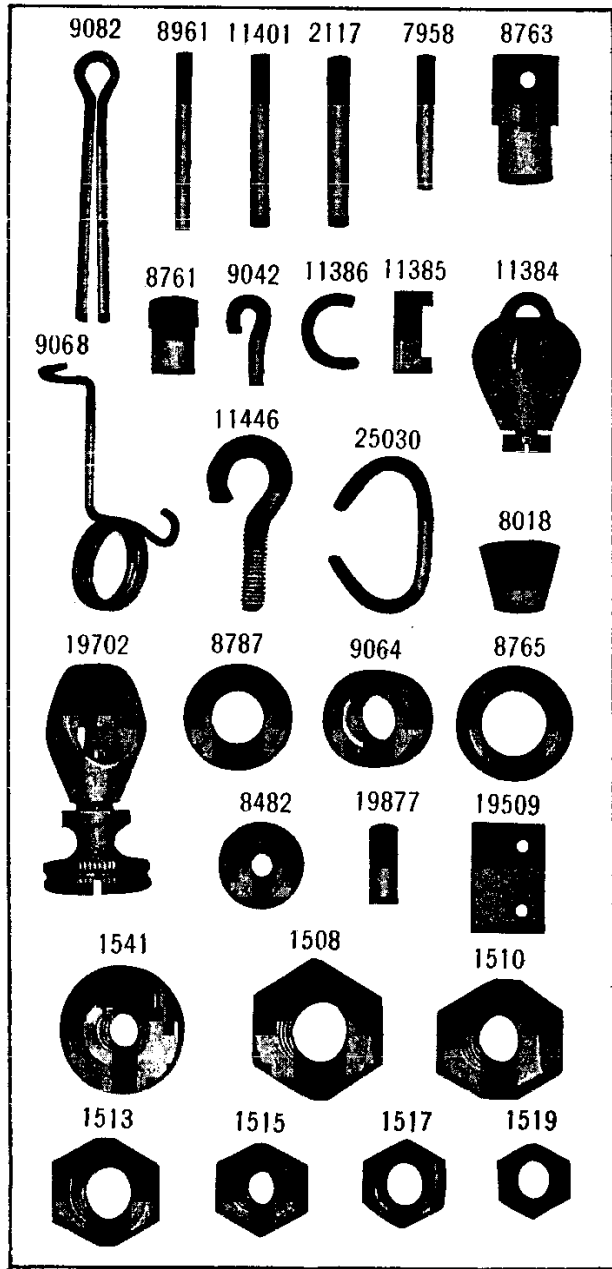

PLATE 891—ONE-HALF SIZE

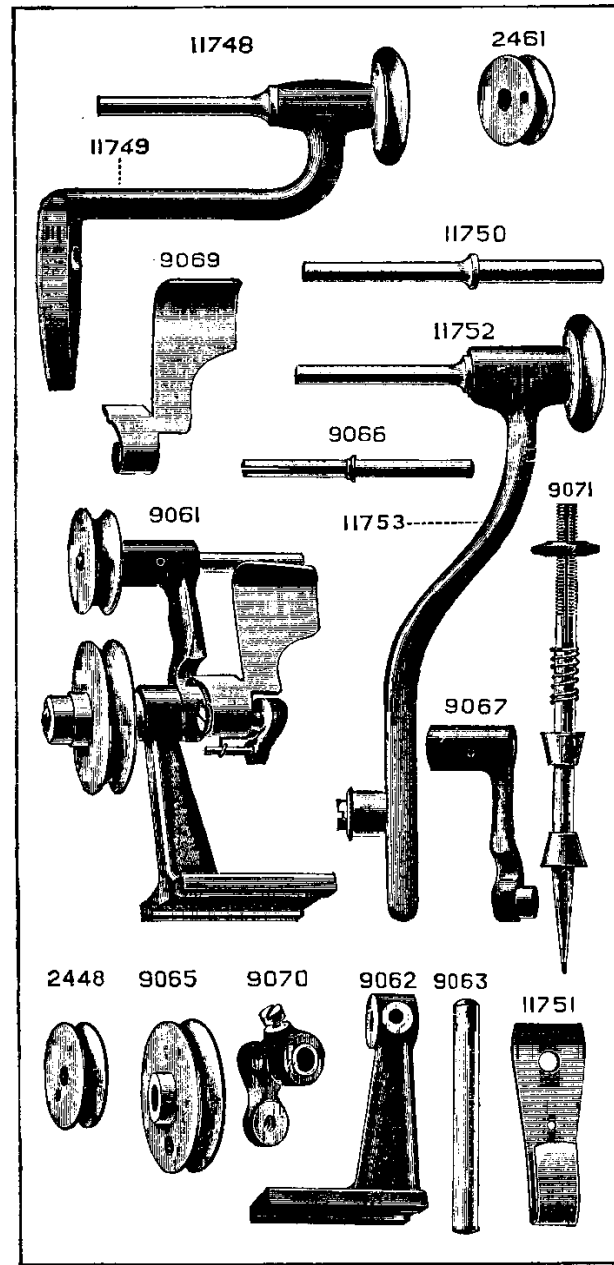

PLATE 892—ONE-HALF SIZE

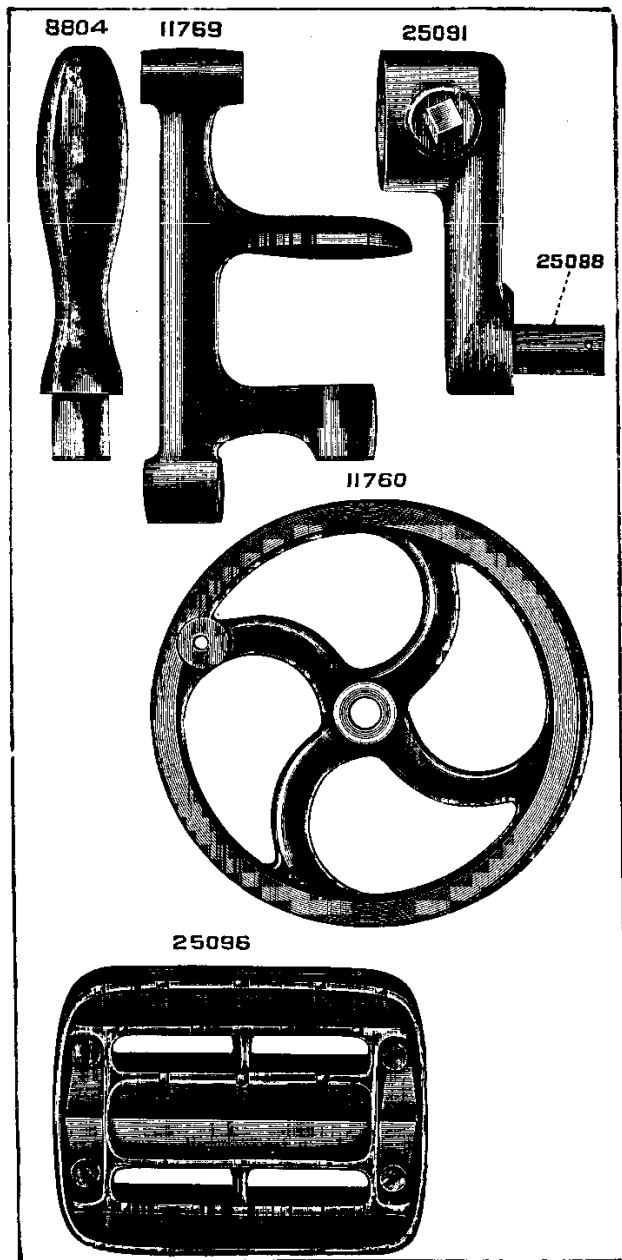

PLATE 893—FULL SIZE

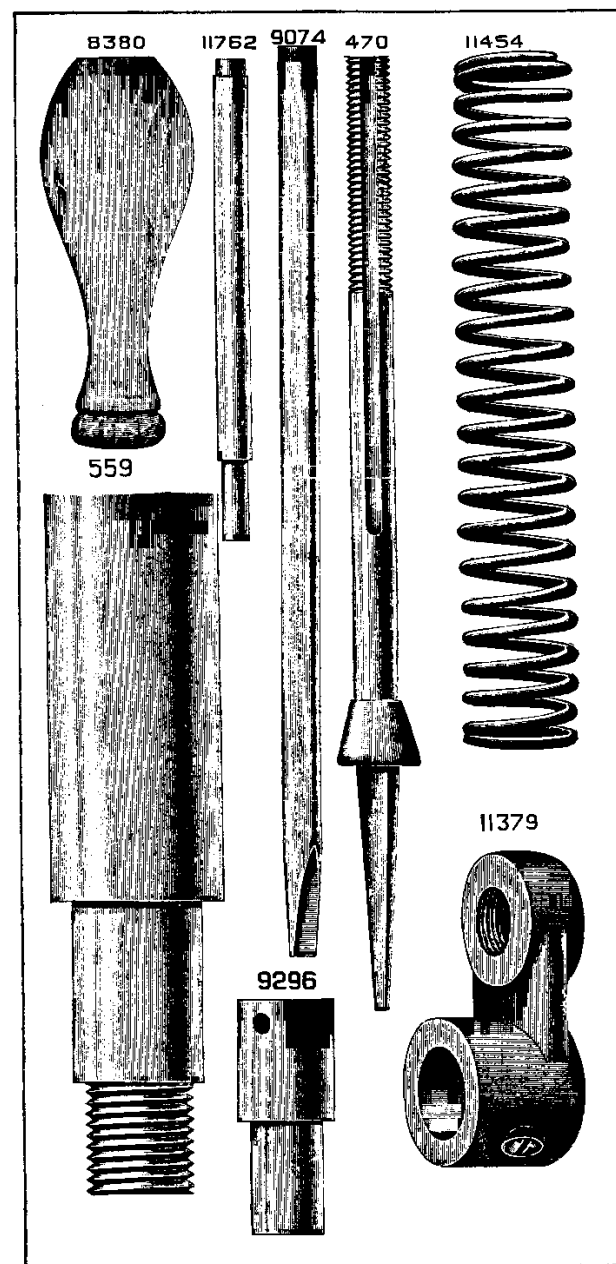
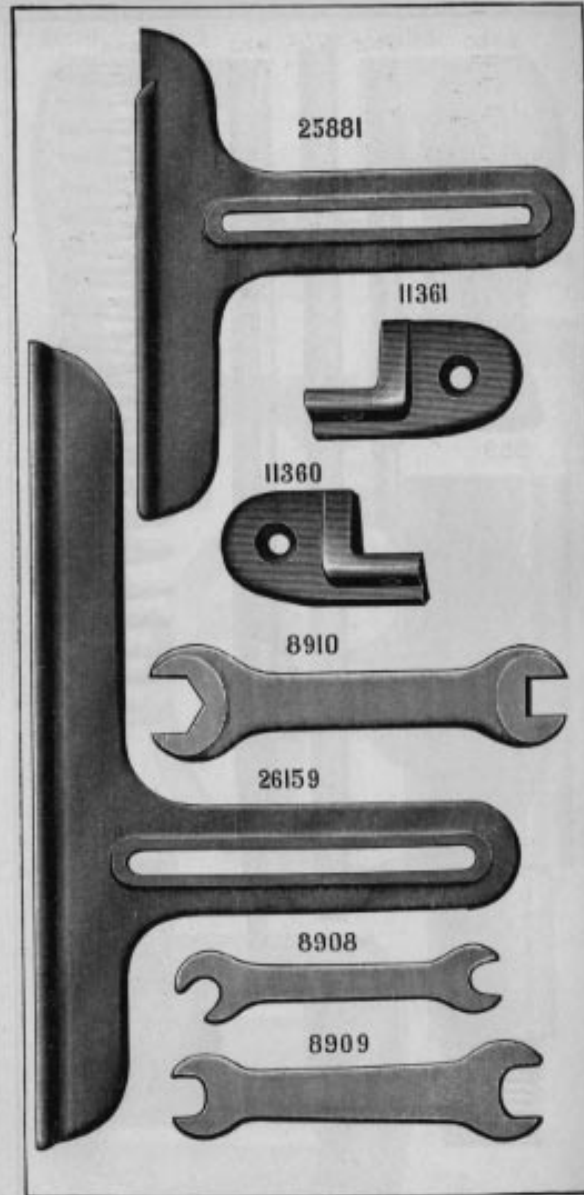

PLATE 894—ONE-HALF SIZE



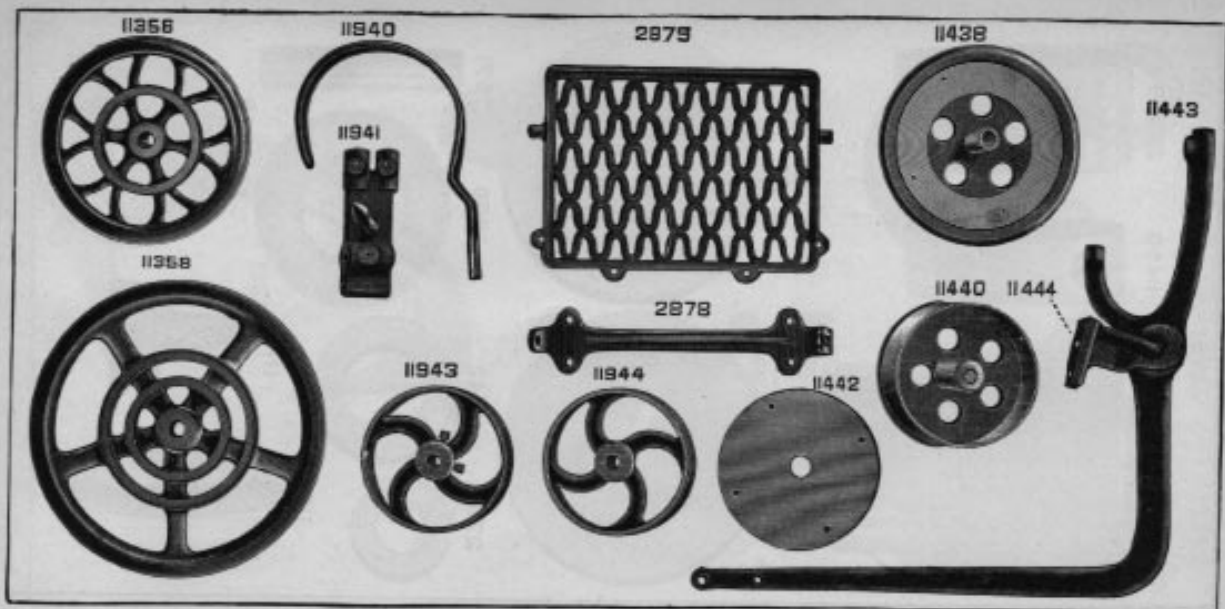

PLATE 896—ONE-EIGHTH SIZE

PLATE 897—FULL SIZE

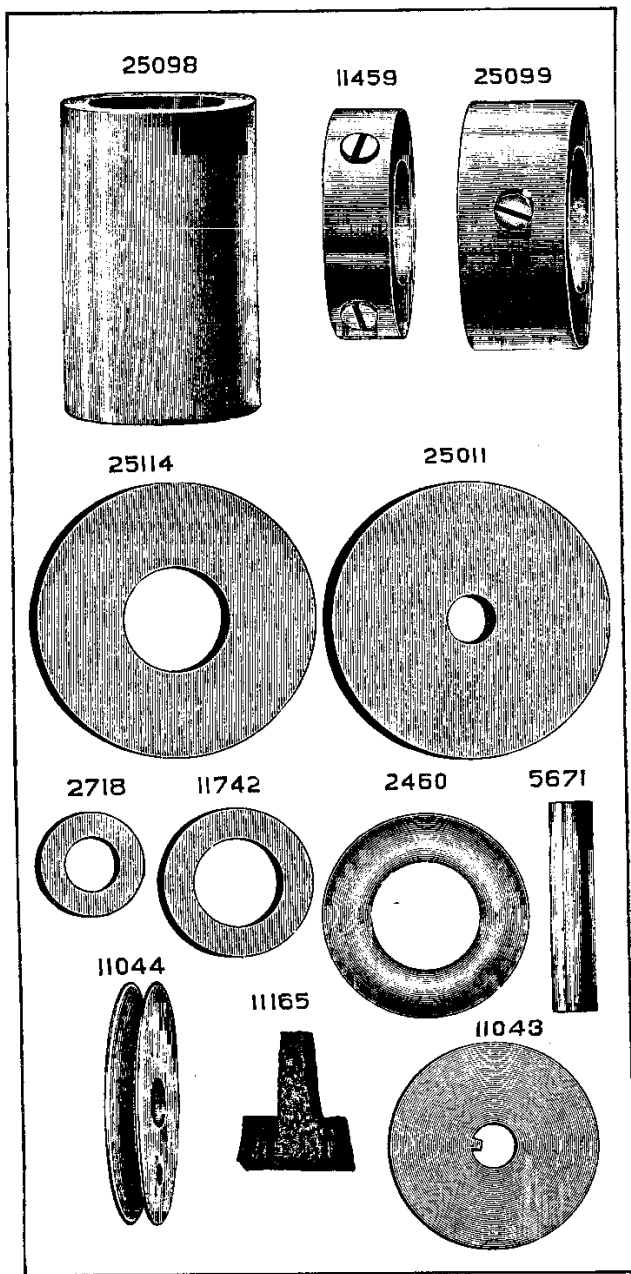
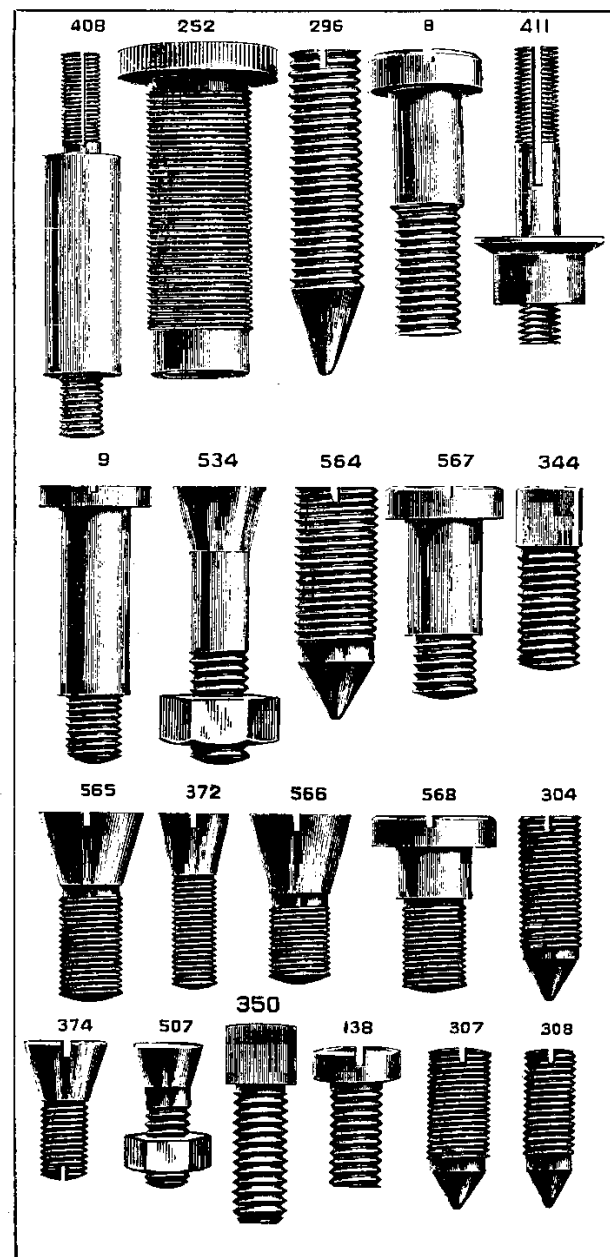

PLATE 898—FULL SIZE



From the library of: Diamond Needle Corp

PLATE 899—FULL SIZE

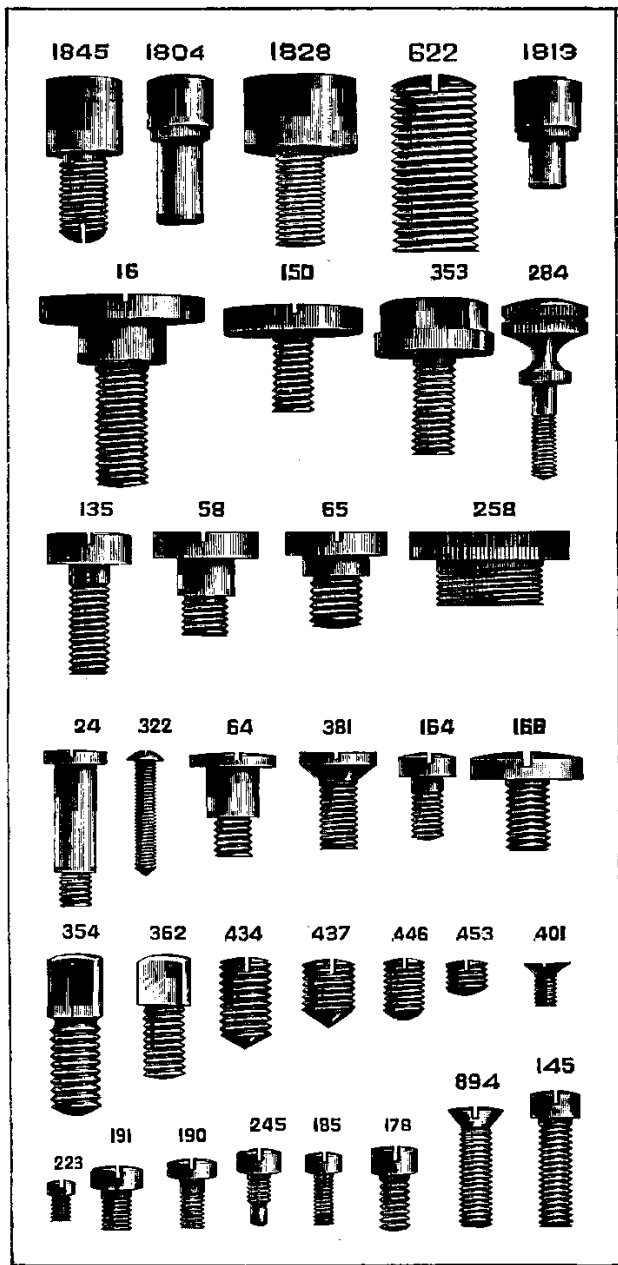

PLATE 900—FULL SIZE

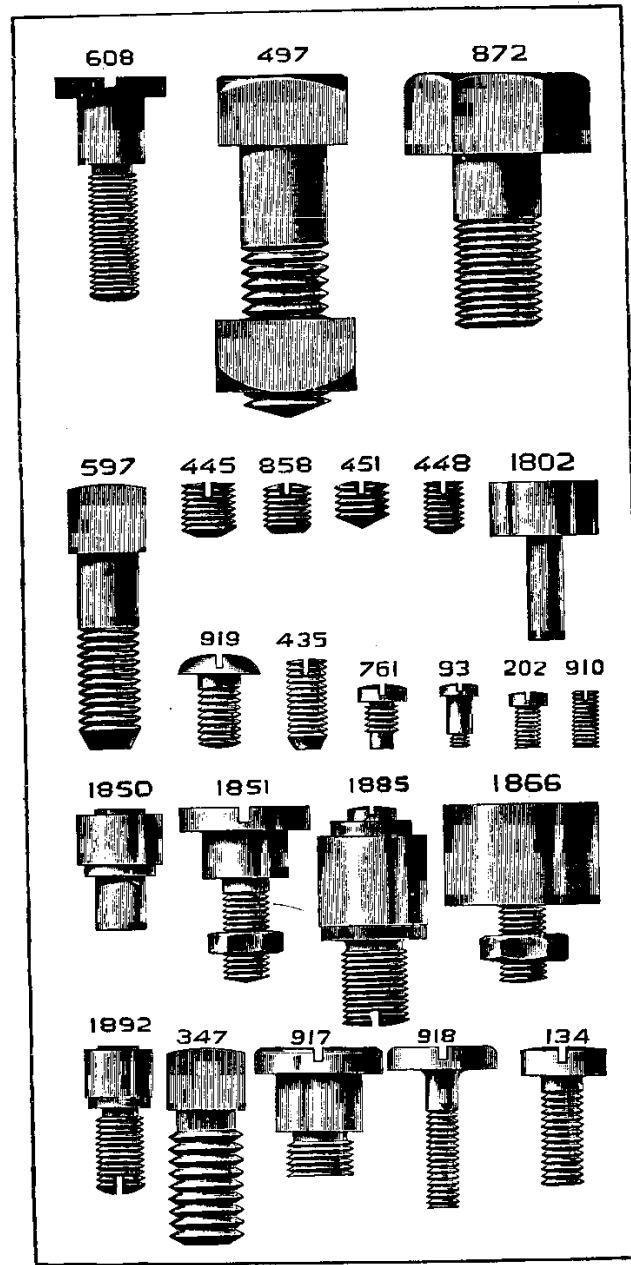

PLATE 901—FULL SIZE

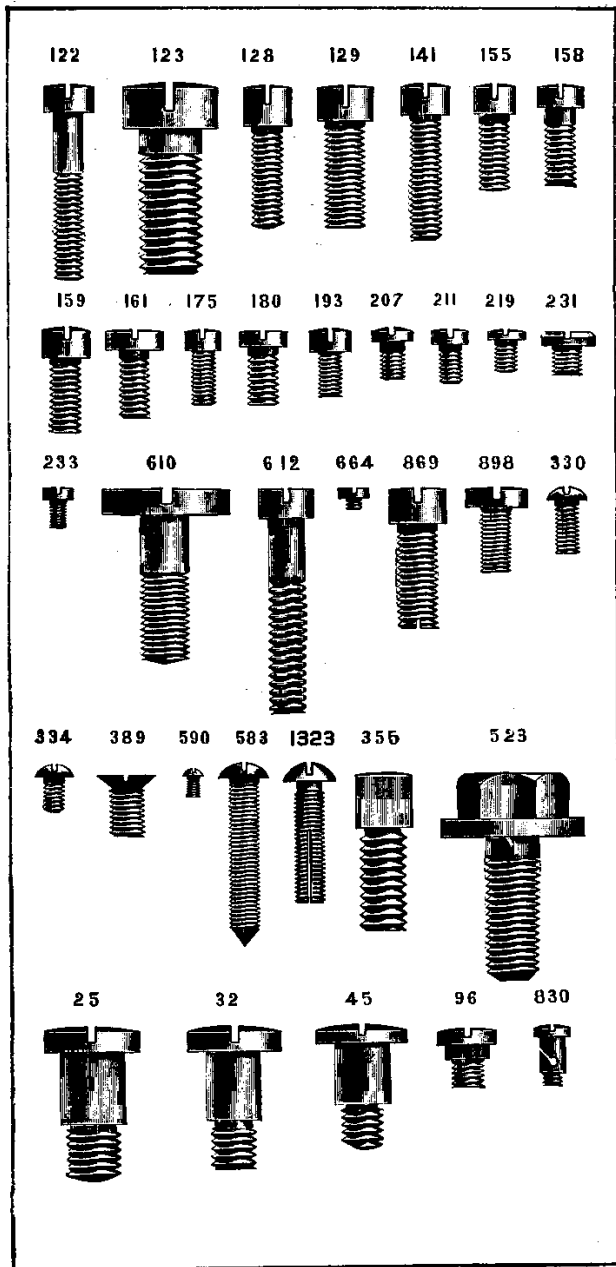

PLATE 902—FULL SIZE

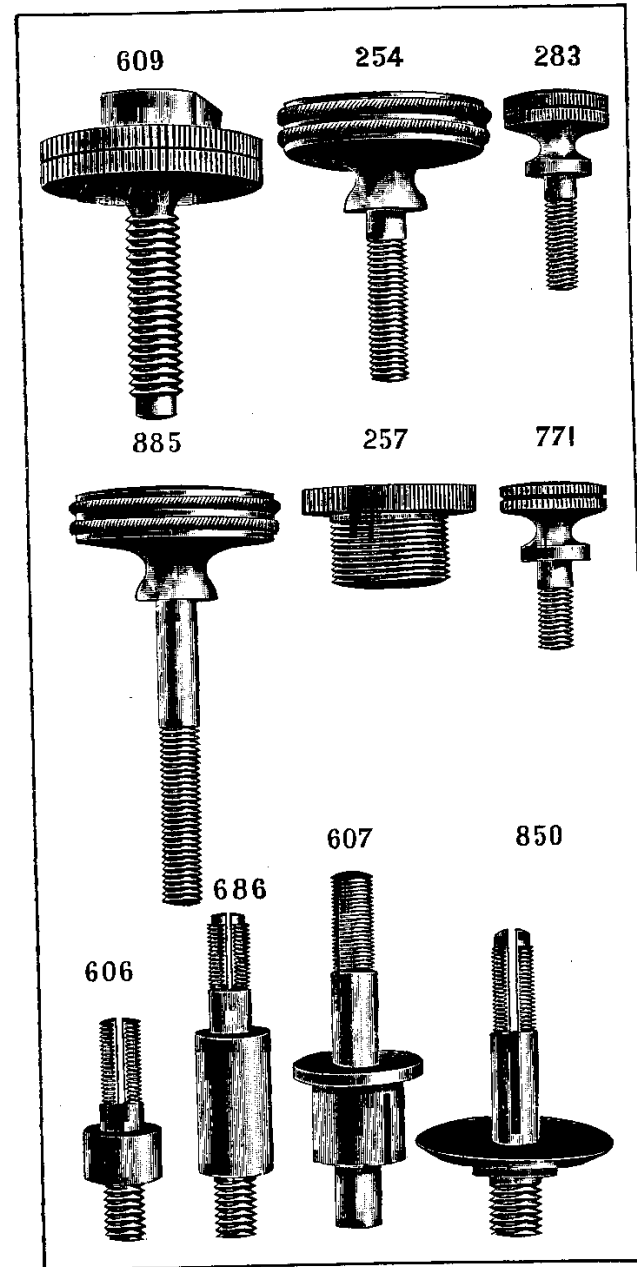

PLATE 903—FULL SIZE

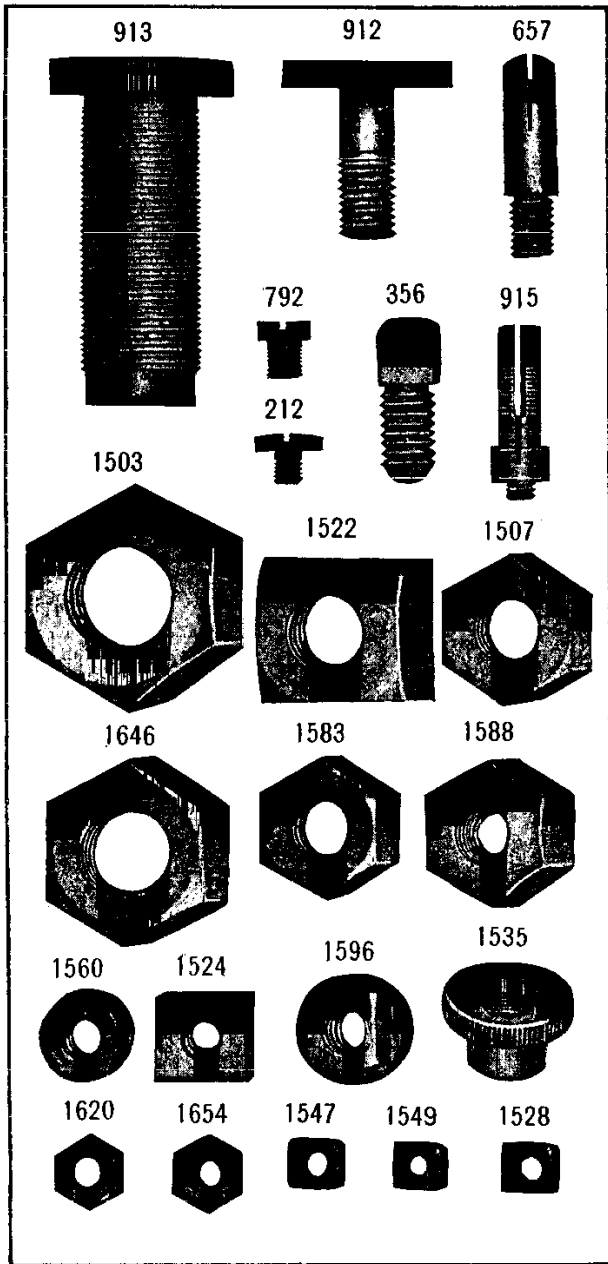

PLATE 904—FULL SIZE

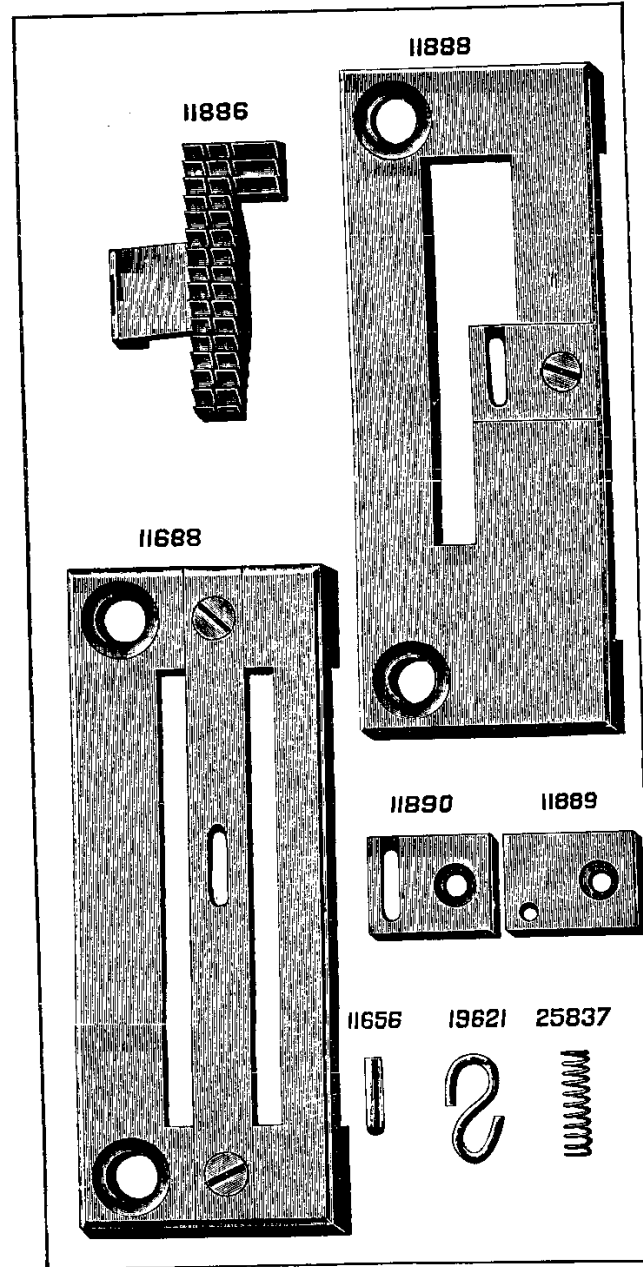

PLATE 905—FULL SIZE

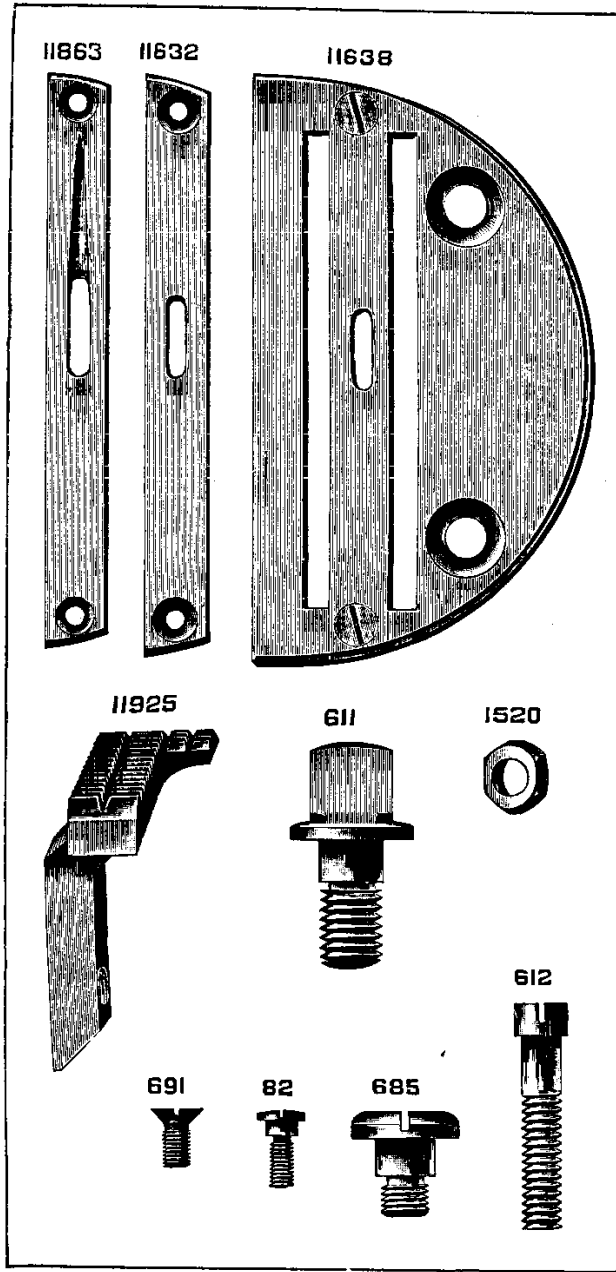

PLATE 906—ONE-NINTH SIZE

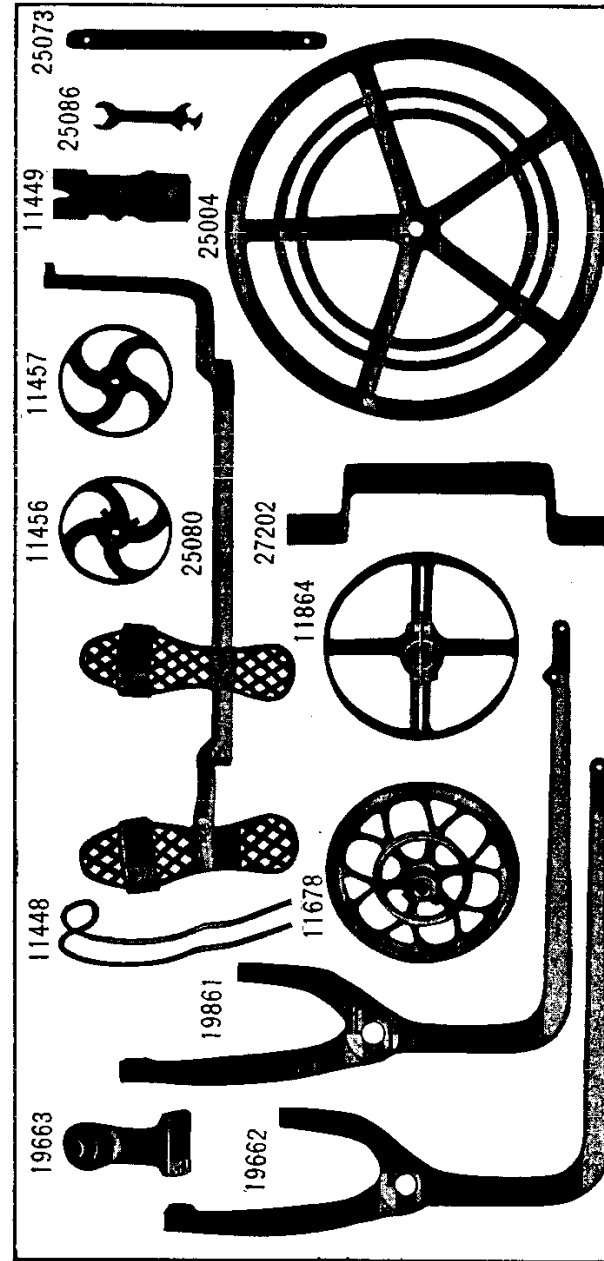

PLATE 907—FULL SIZE

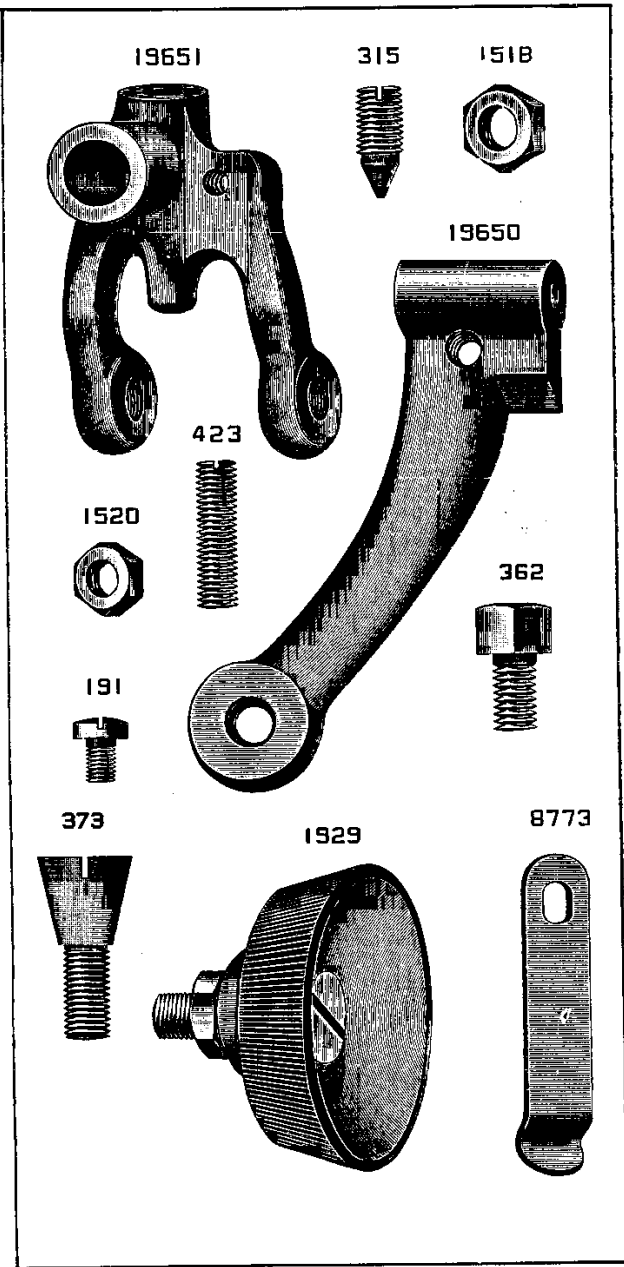

PLATE 908—ONE-HALF SIZE

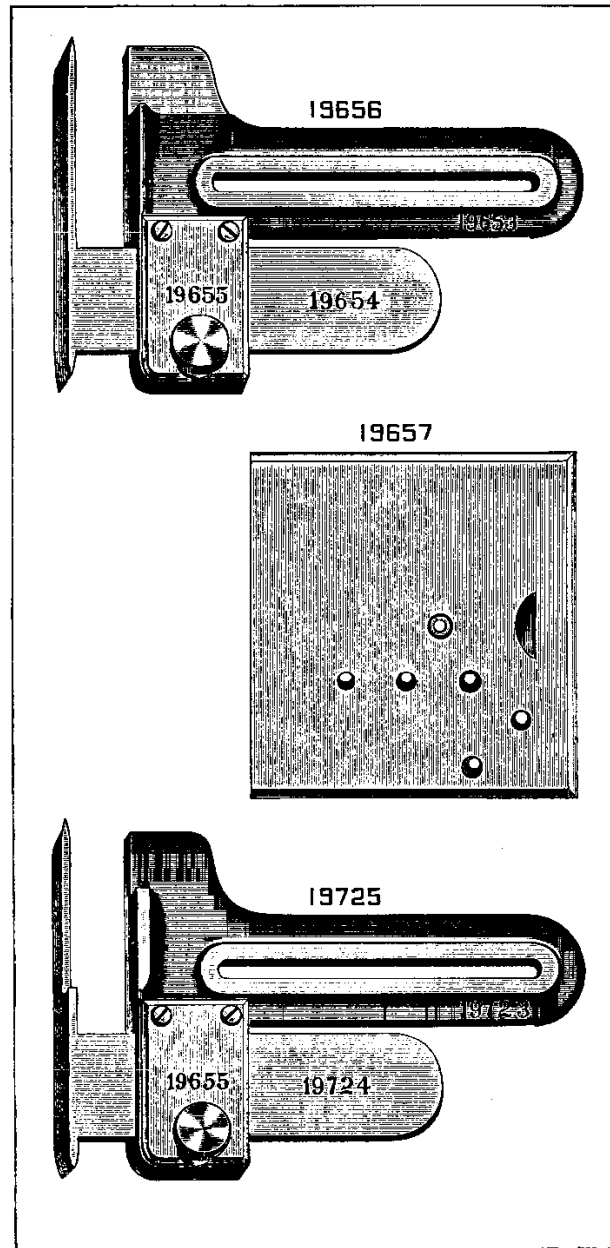

PLATE 909—FULL SIZE

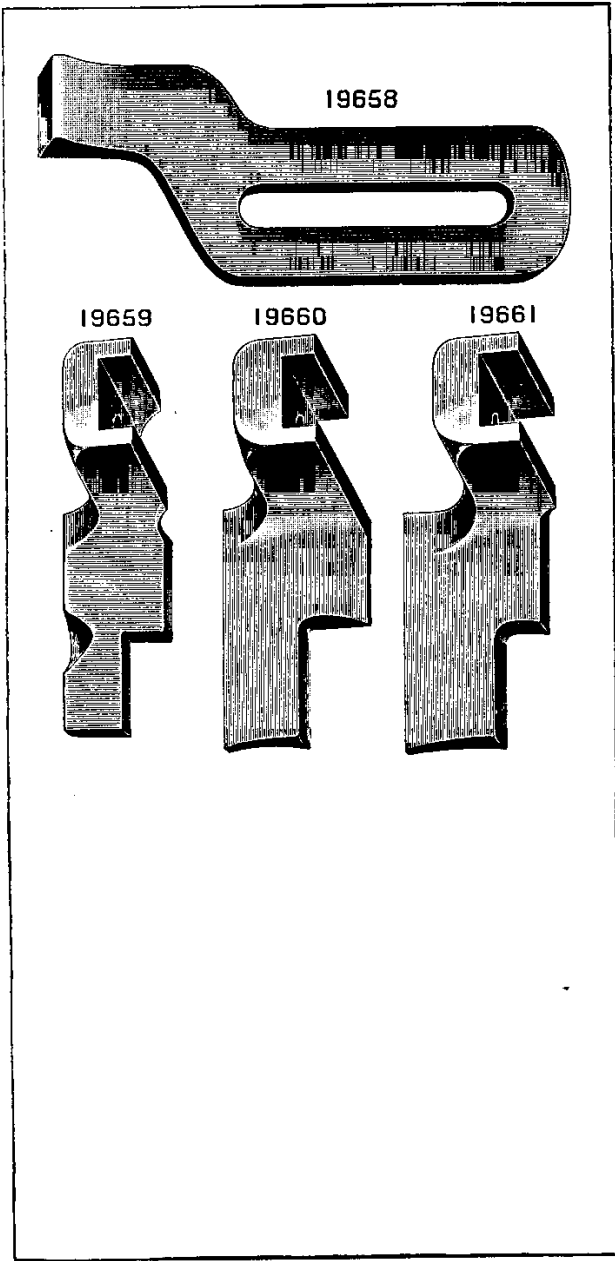
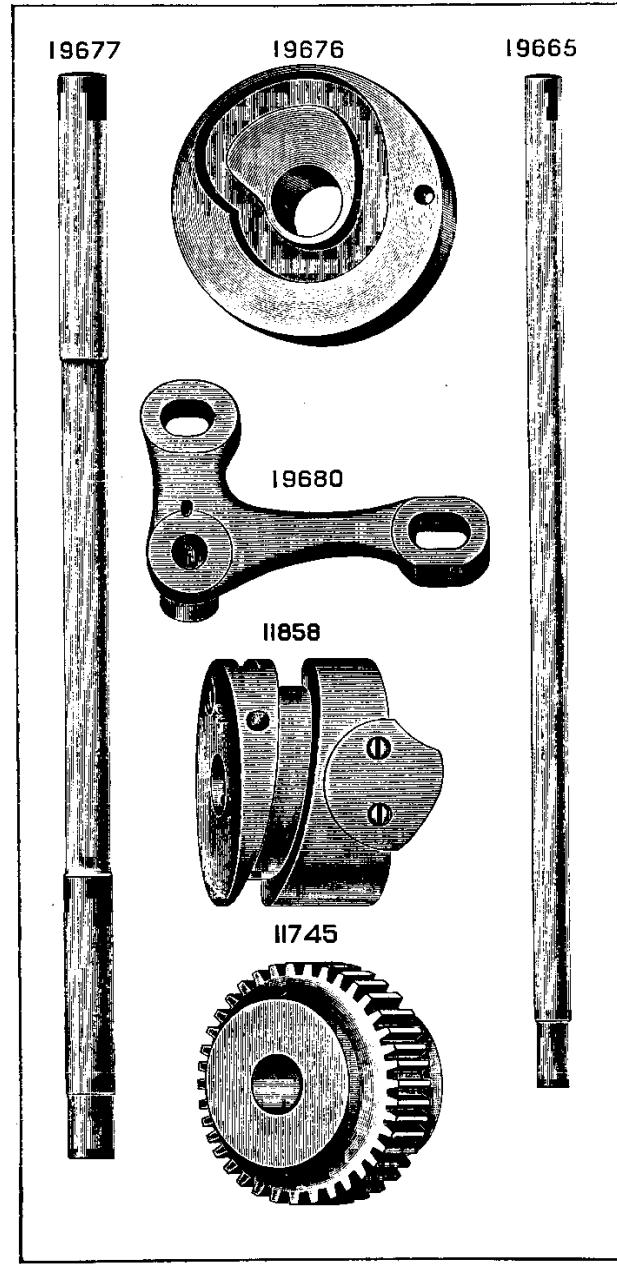

PLATE 910—ONE-HALF SIZE



From the library of: Diamond Needle Corp

PLATE 911—ONE-HALF SIZE

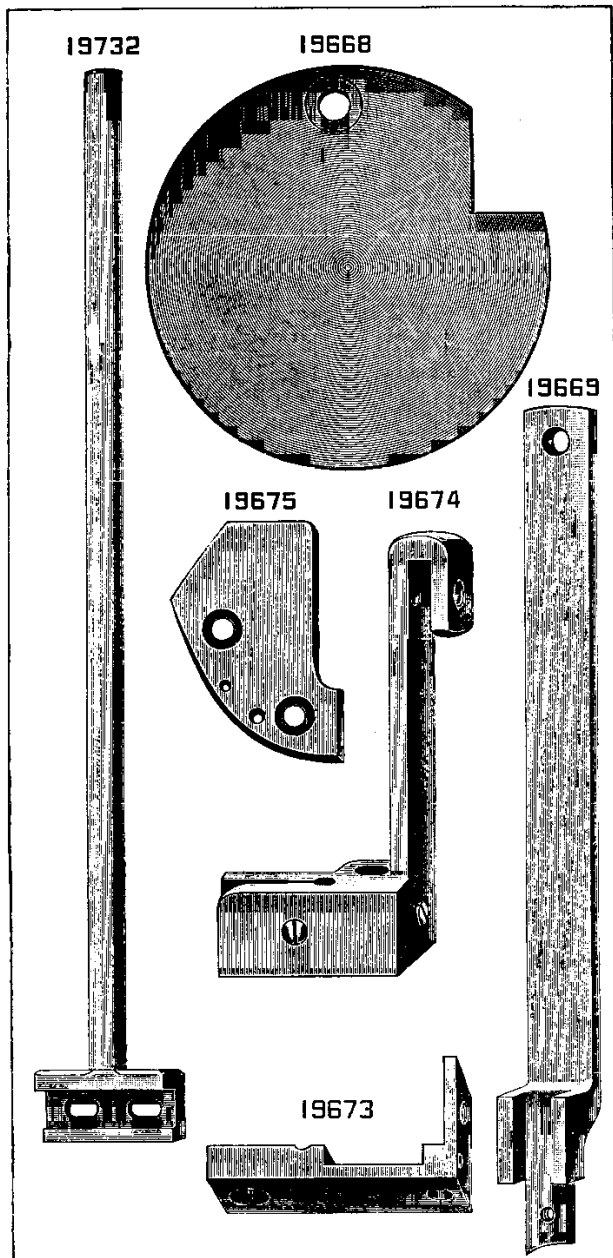
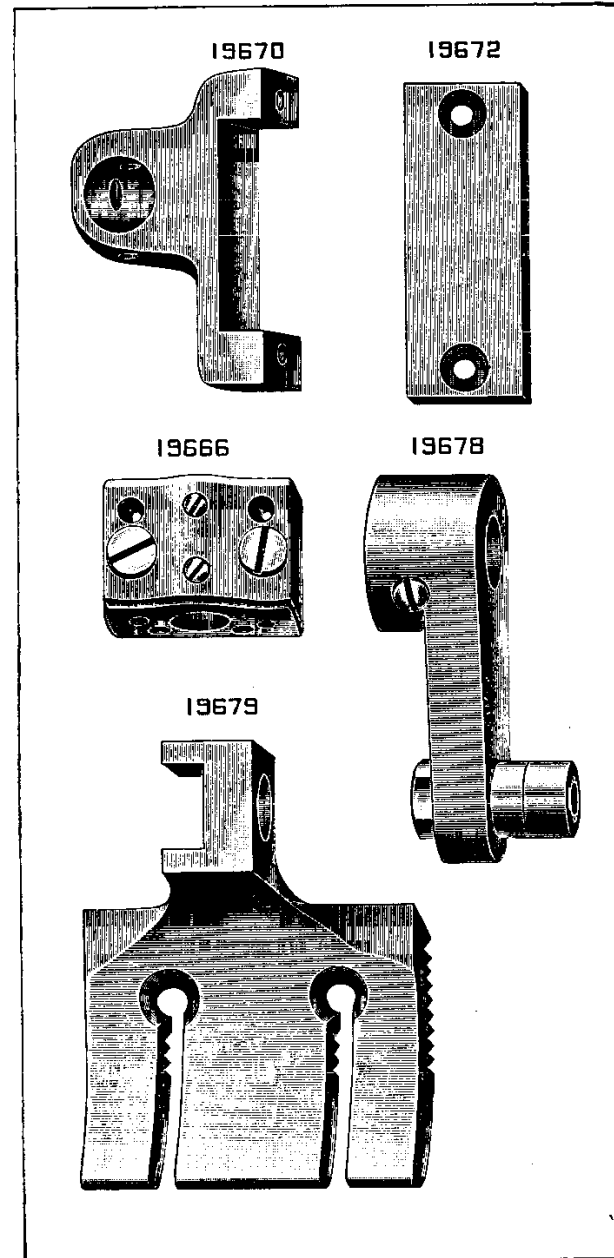

PLATE 912—FULL SIZE



From the library of: Diamond Needle Corp

PLATE 913—FULL SIZE

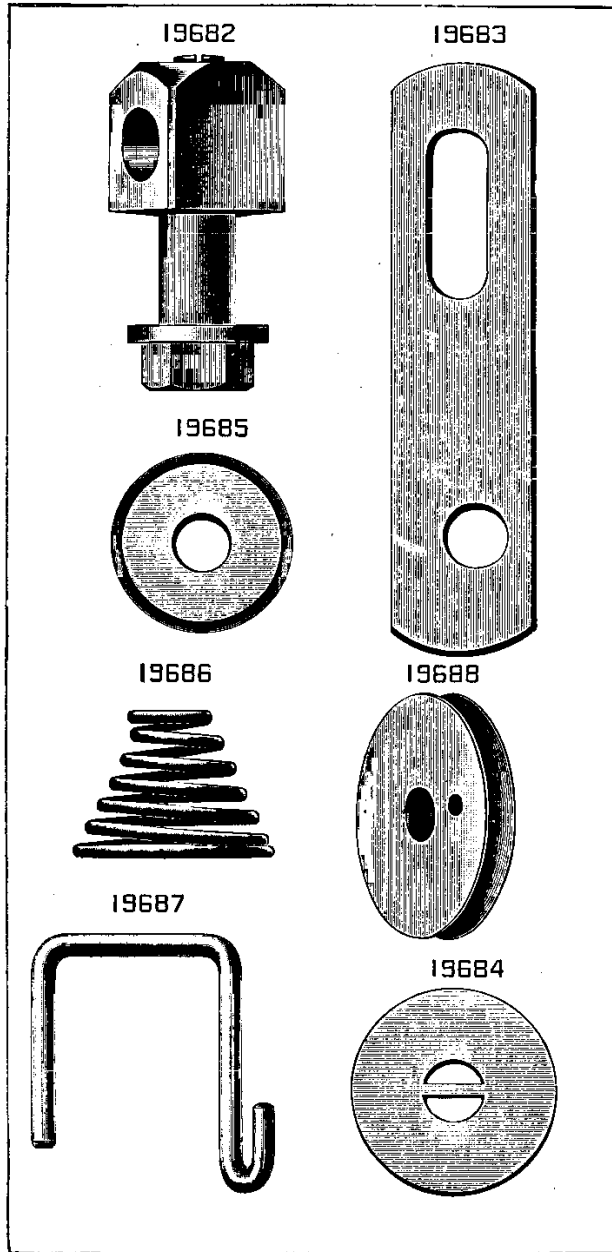
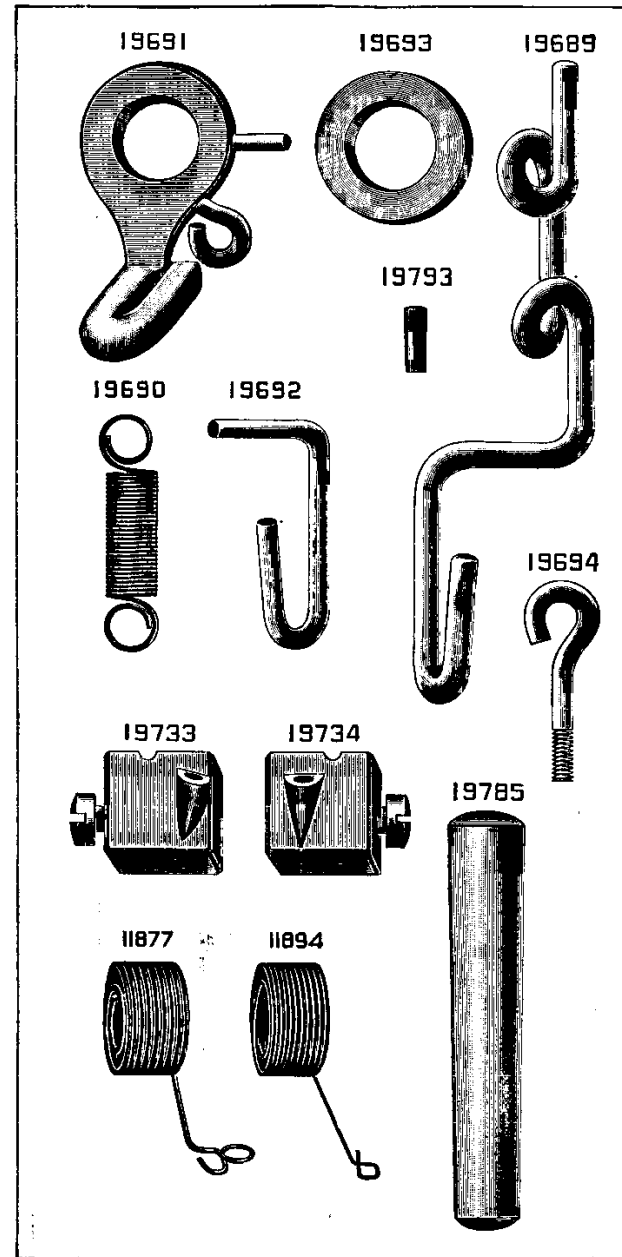

PLATE 914—FULL SIZE



From the library of: Diamond Needle Corp

PLATE 915—ONE-FOURTH SIZE

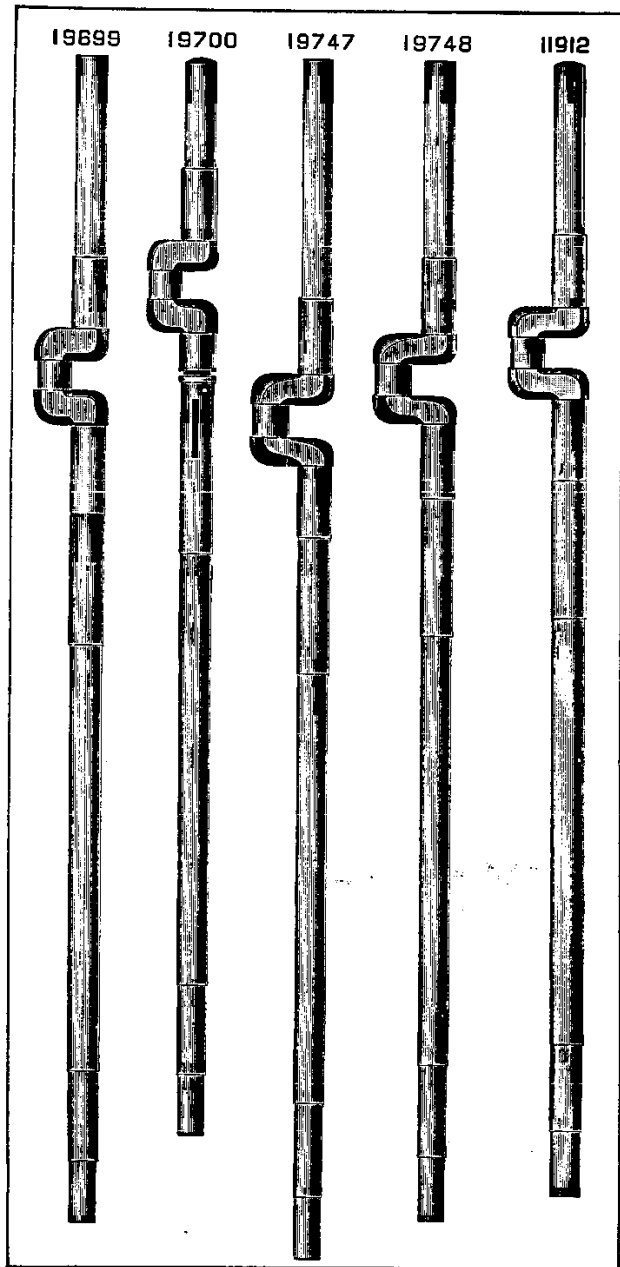
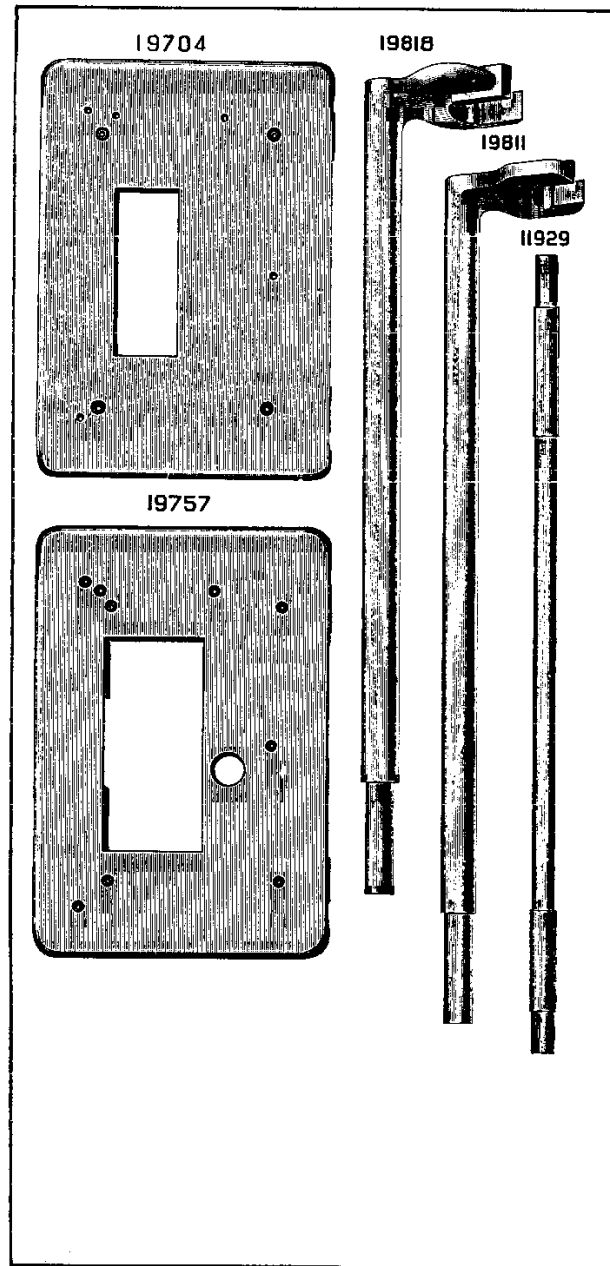

PLATE 916—ONE-FOURTH SIZE



From the library of: Diamond Needle Corp

PLATE 917—FULL SIZE

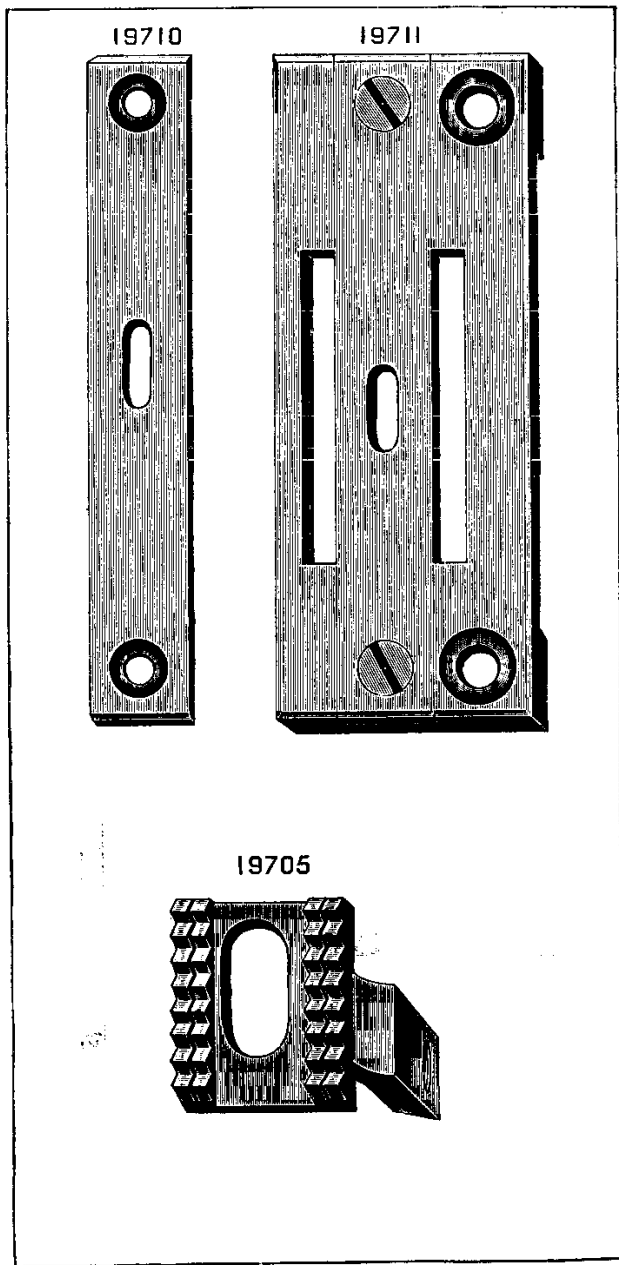

PLATE 920—FULL SIZE

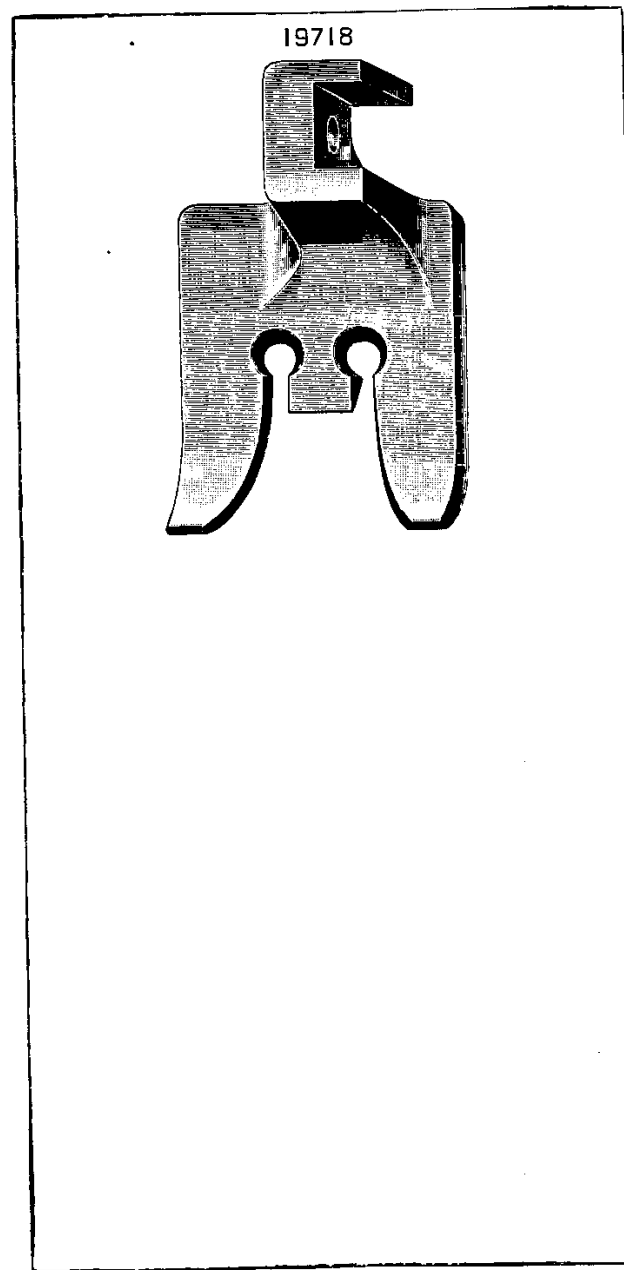

PLATE 921—FULL SIZE

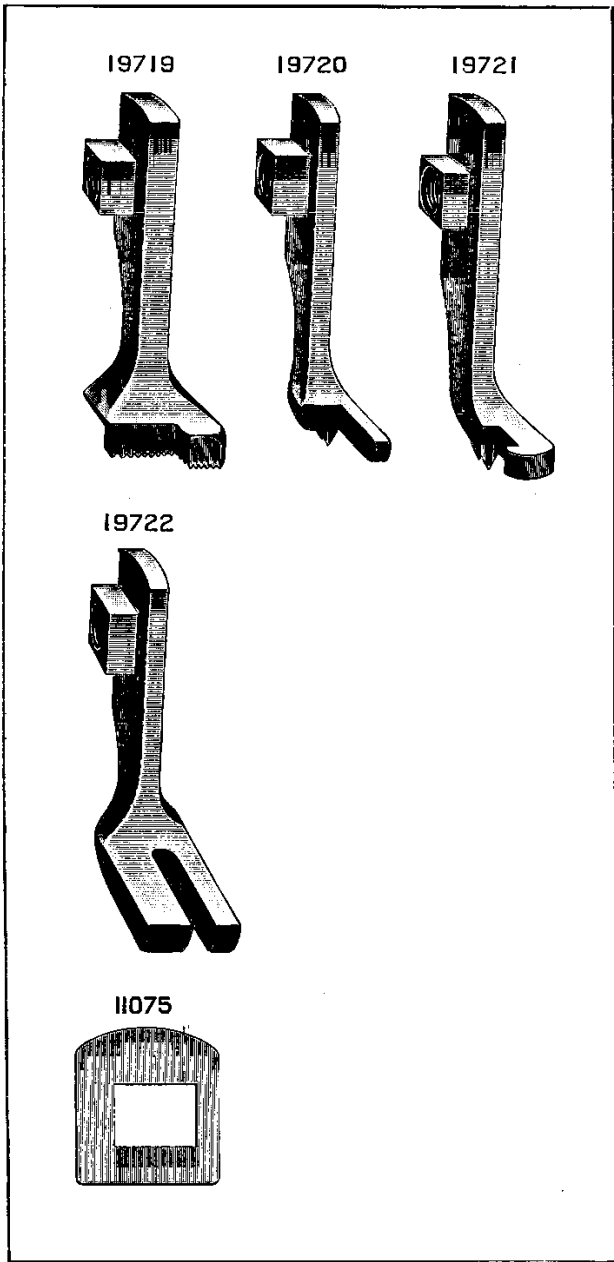
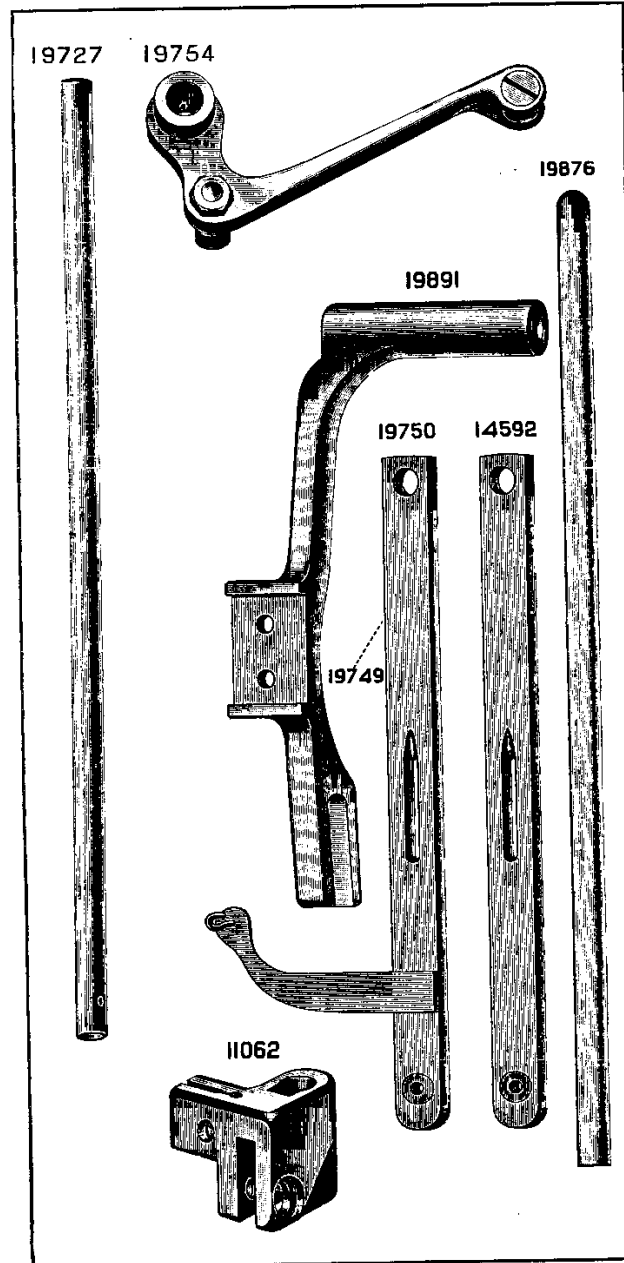

PLATE 922—ONE-HALF SIZE



From the library of: Diamond Needle Corp

PLATE 923—FULL SIZE

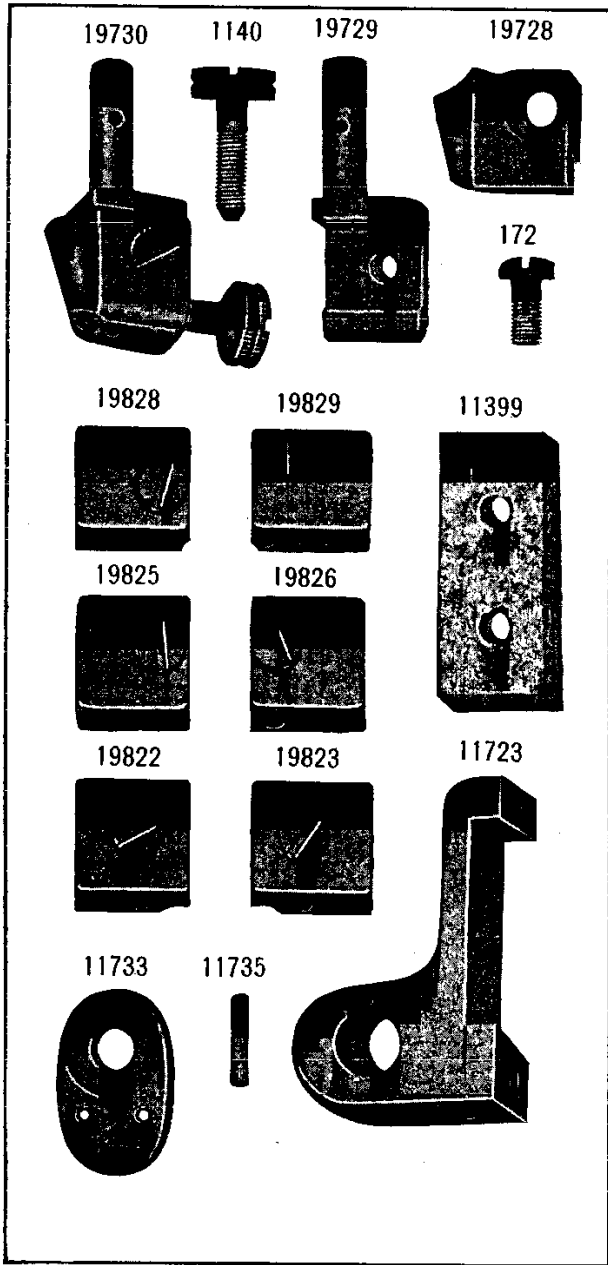

PLATE 924—FULL SIZE

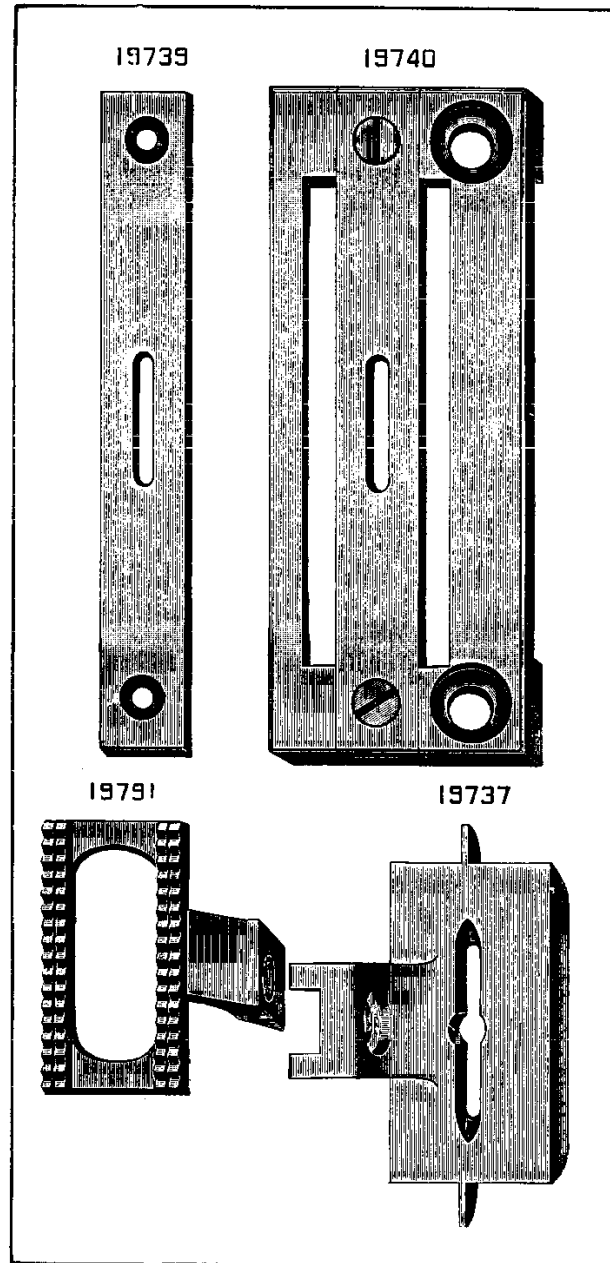
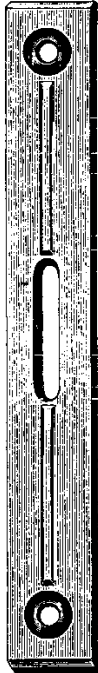

PLATE 925—FULL SIZE

19742



19743

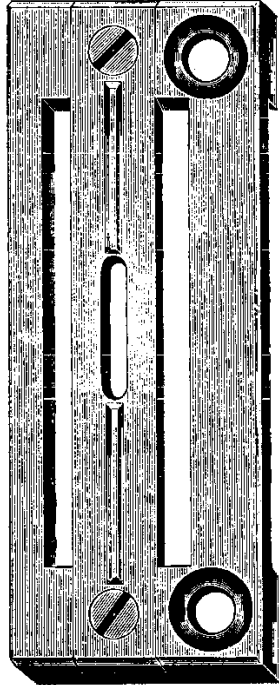
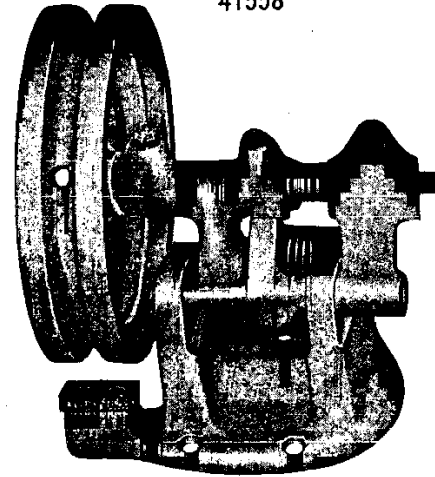
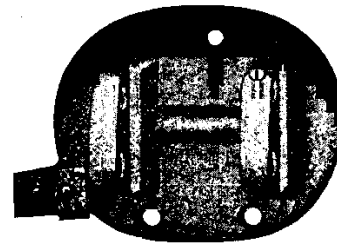

PLATE 3579—ONE-HALF SIZE

41558



41439



41557



41444



41446



PLATE 3580—ONE-HALF SIZE

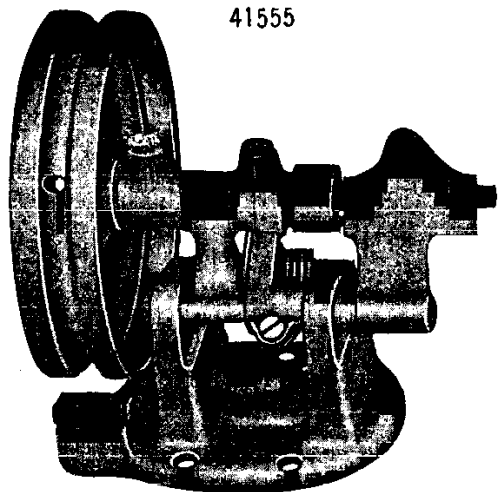

41555

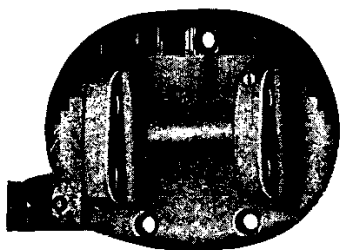

41550



41554



41552



11107

PLATE 3581—ONE-HALF SIZE

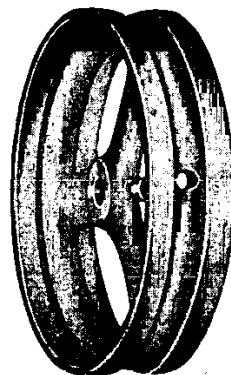

41443



41447

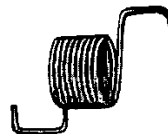

41442



41441

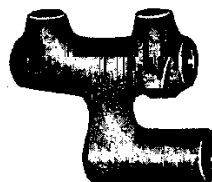

41440

PLATE 3582—ONE-FOURTH SIZE

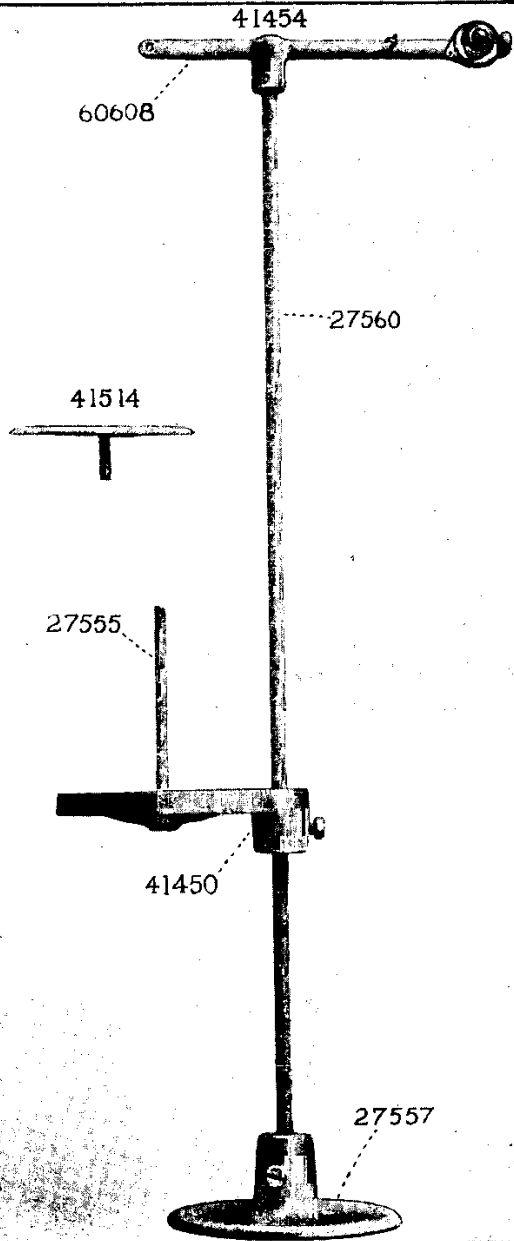

PLATE 3583—FULL SIZE

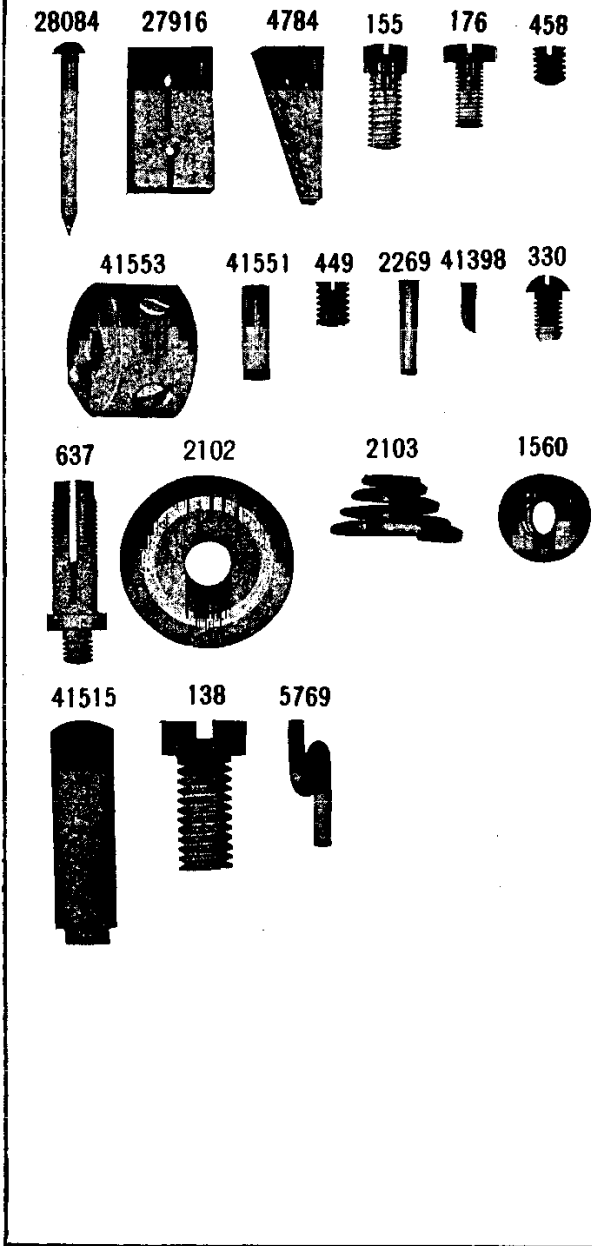

PLATE 4400—FULL SIZE

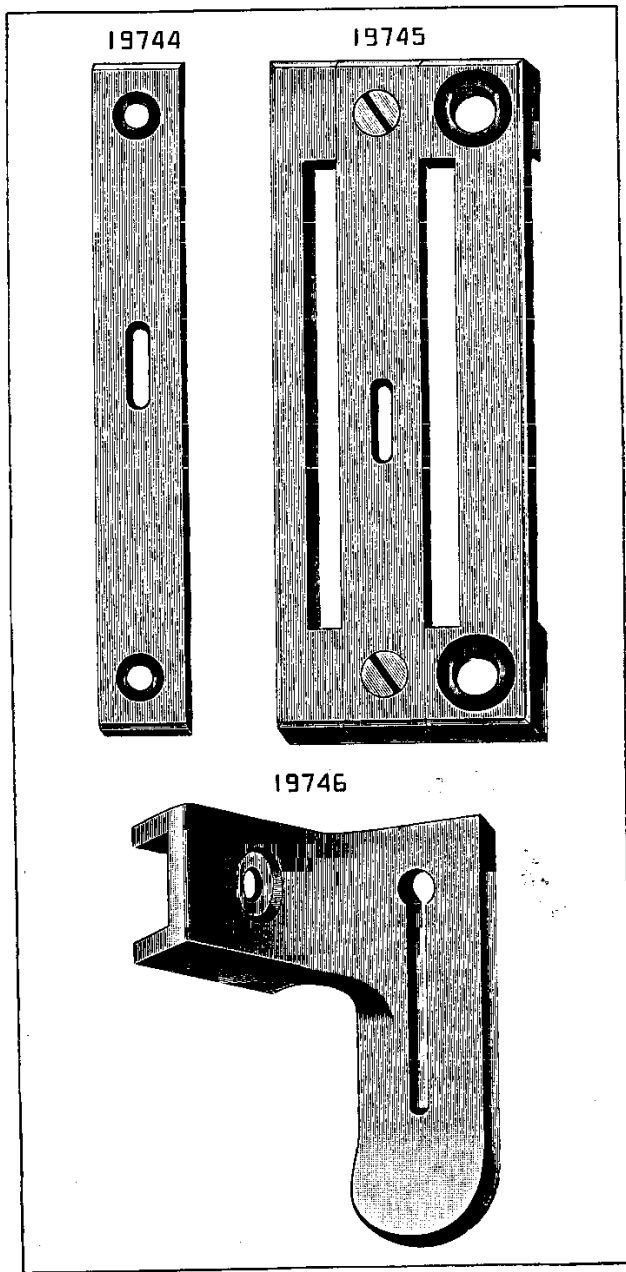
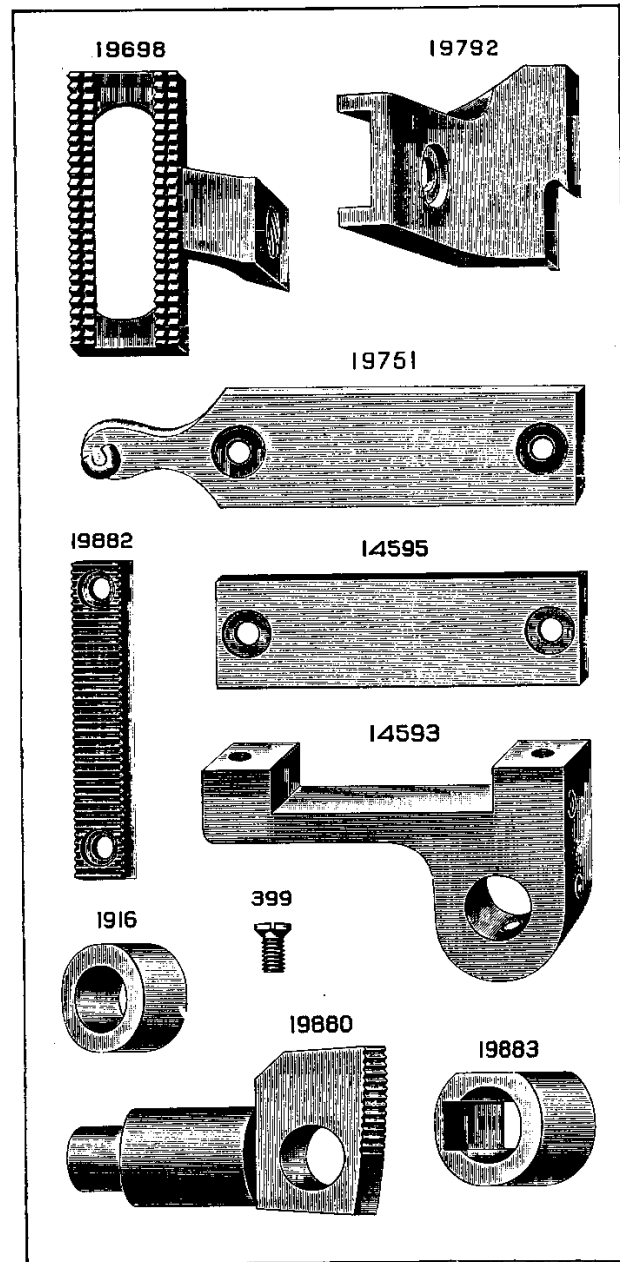

PLATE 4401—FULL SIZE



From the library of: Diamond Needle Corp

PLATE 4402—ONE-FOURTH SIZE

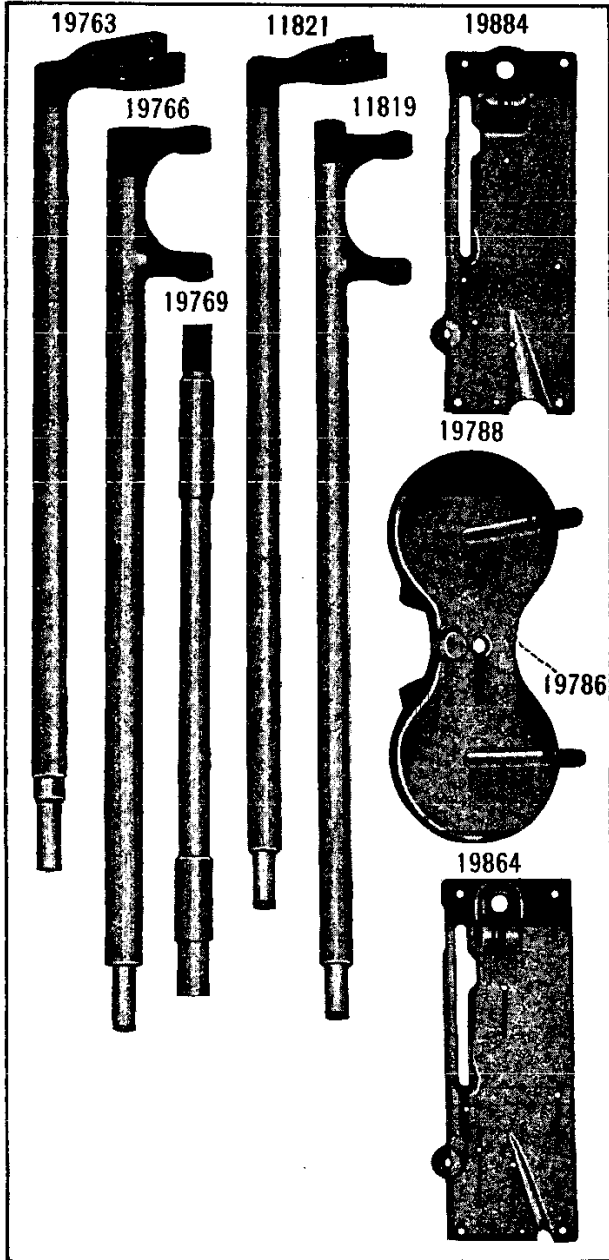

PLATE 4403—ONE-HALF SIZE

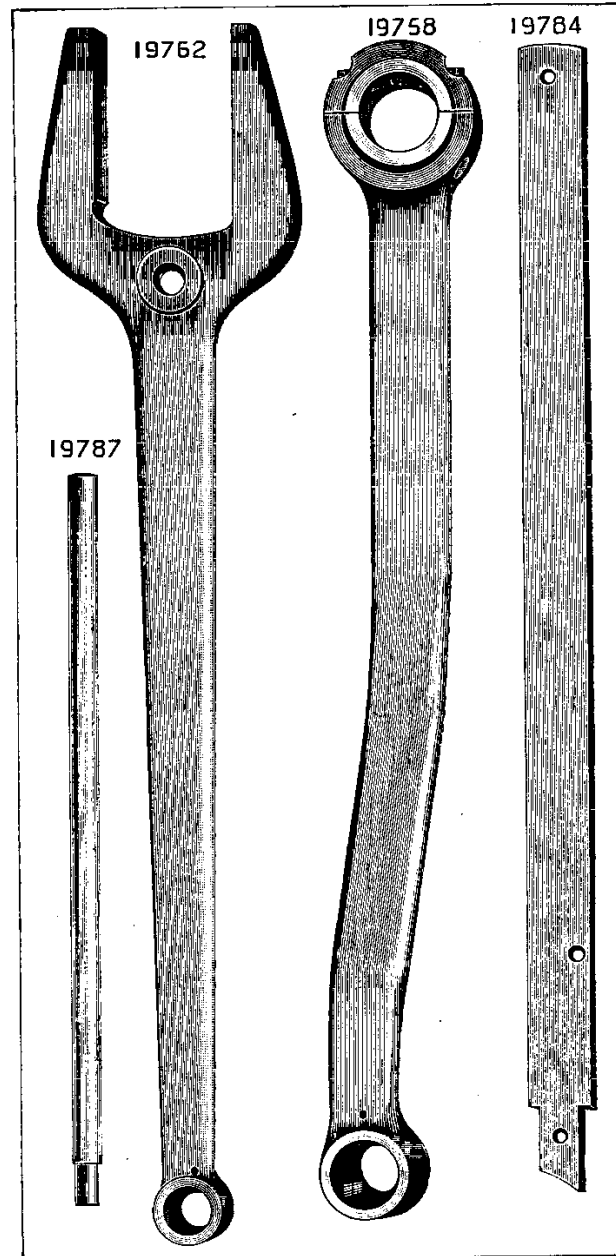

PLATE 4404--ONE-HALF SIZE

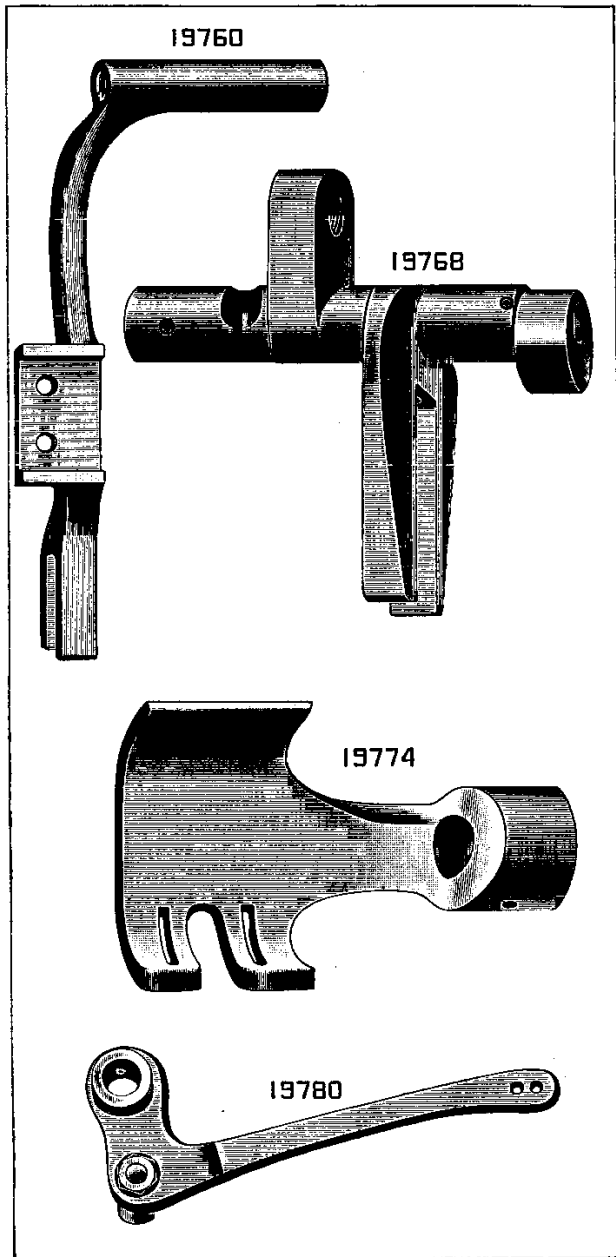

PLATE 4406--FULL SIZE

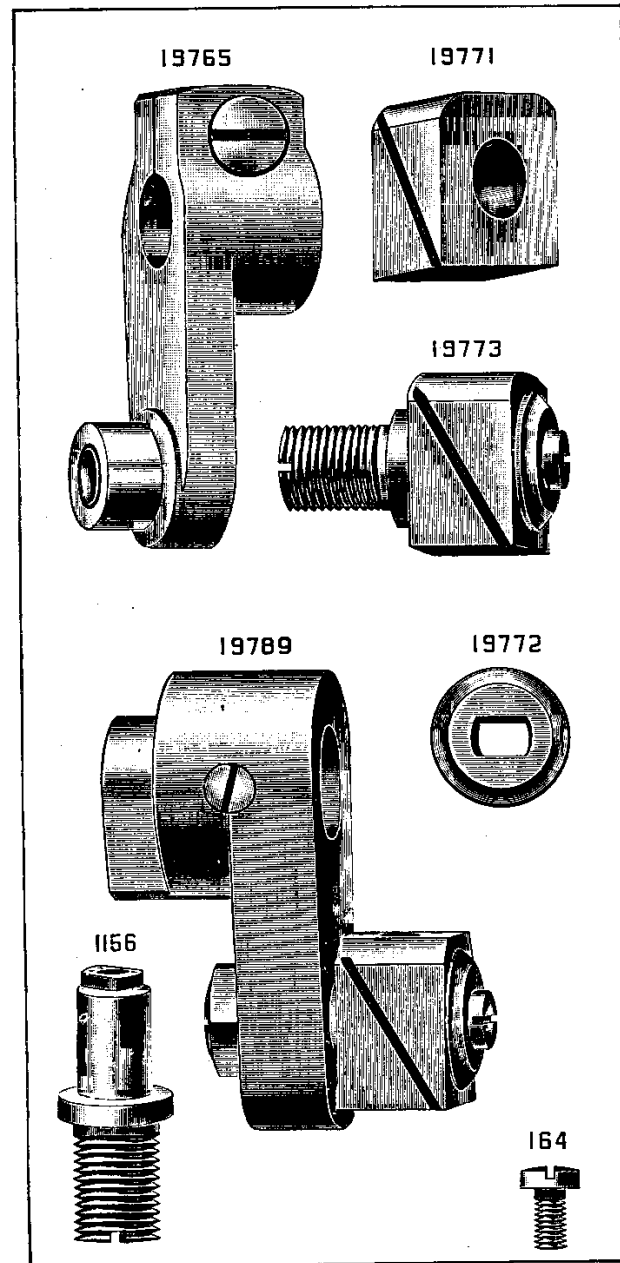
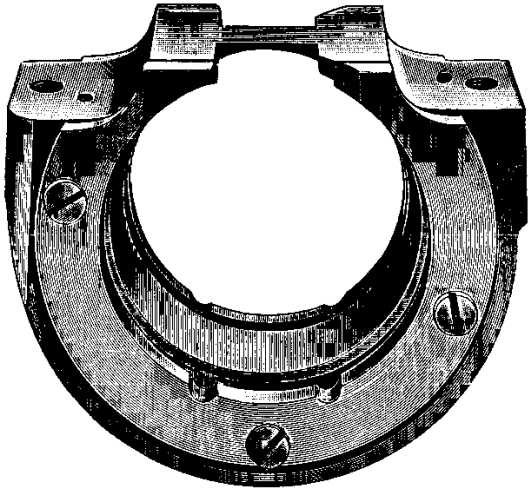
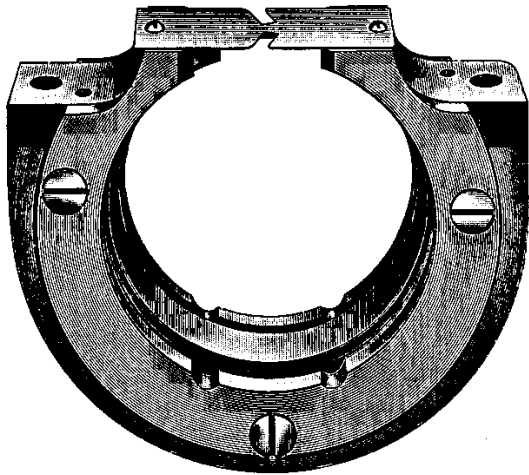

PLATE 4407—ONE-HALF SIZE

19778



19897



19896



PLATE 4408—ONE-HALF SIZE

19776

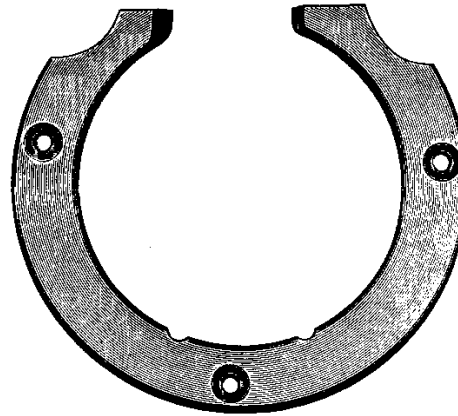

19777

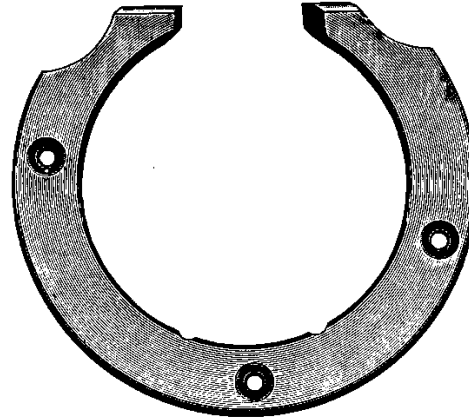

PLATE 4409—ONE-HALF SIZE

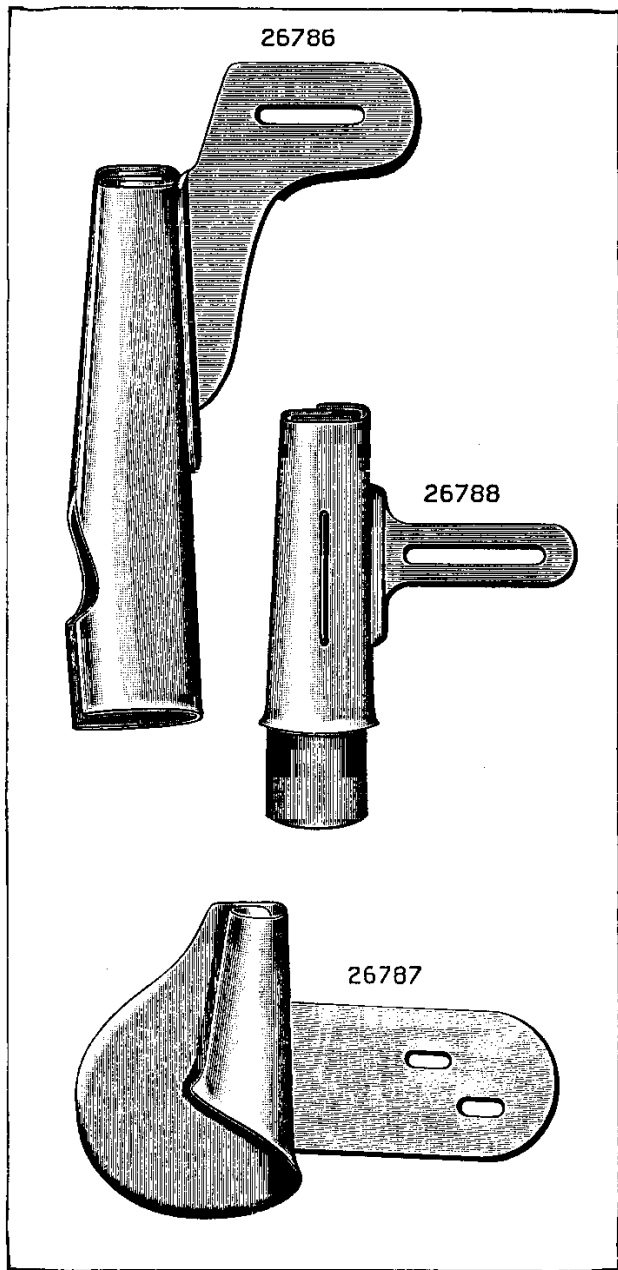

PLATE 4410—ONE-HALF SIZE

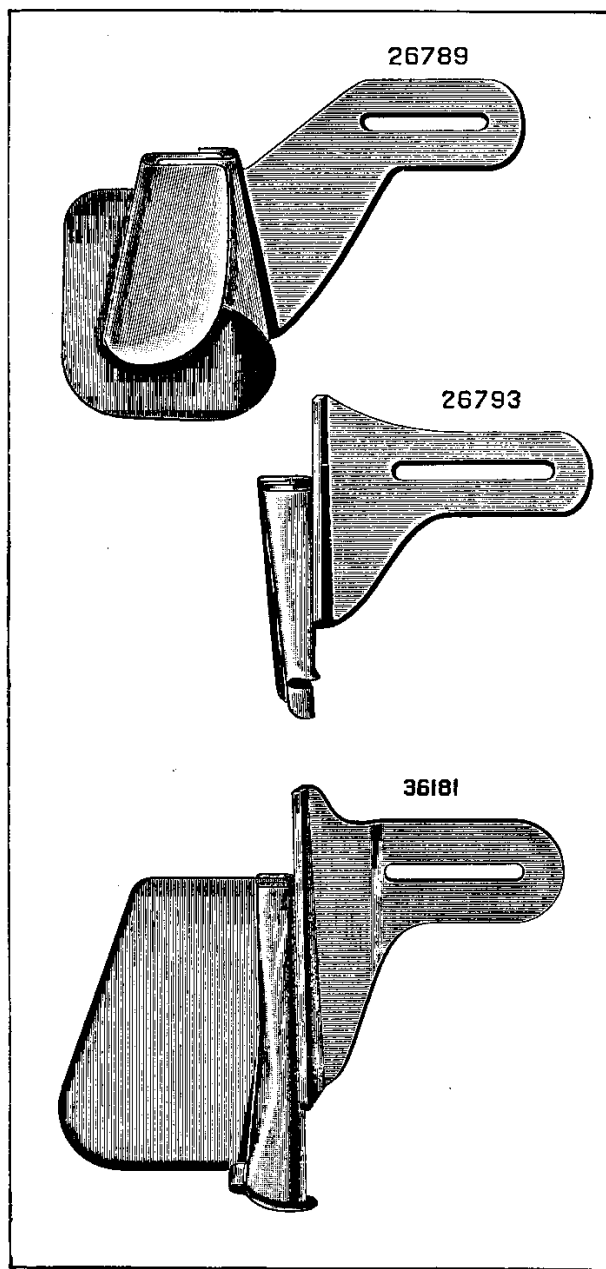

PLATE 4412—FULL SIZE

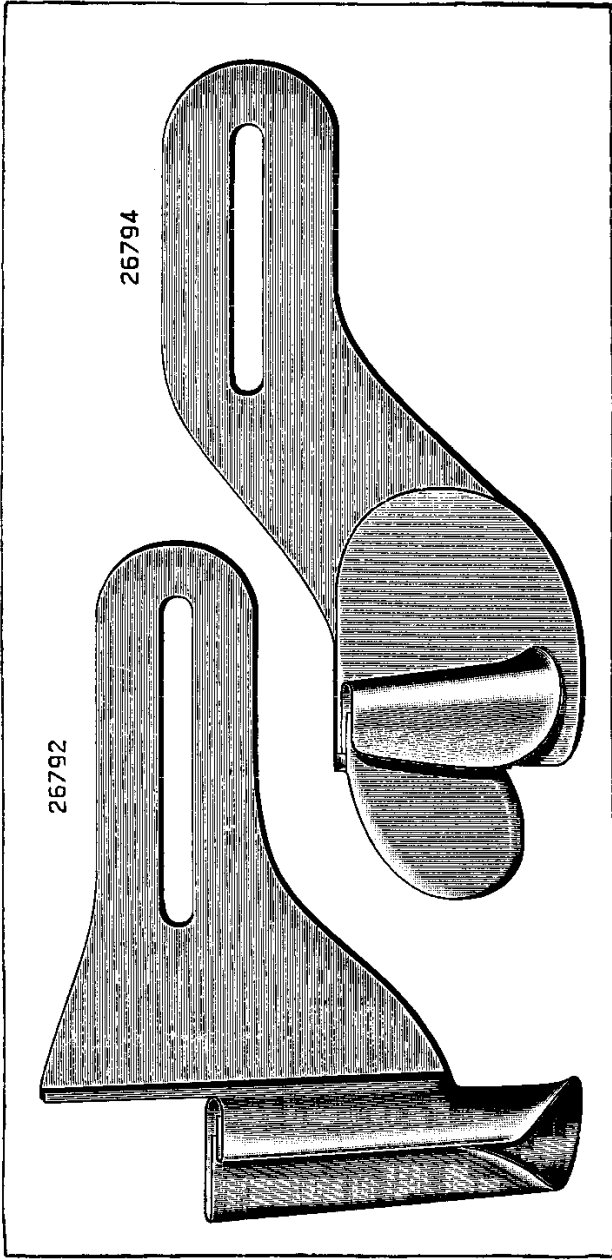

PLATE 4413—FULL SIZE

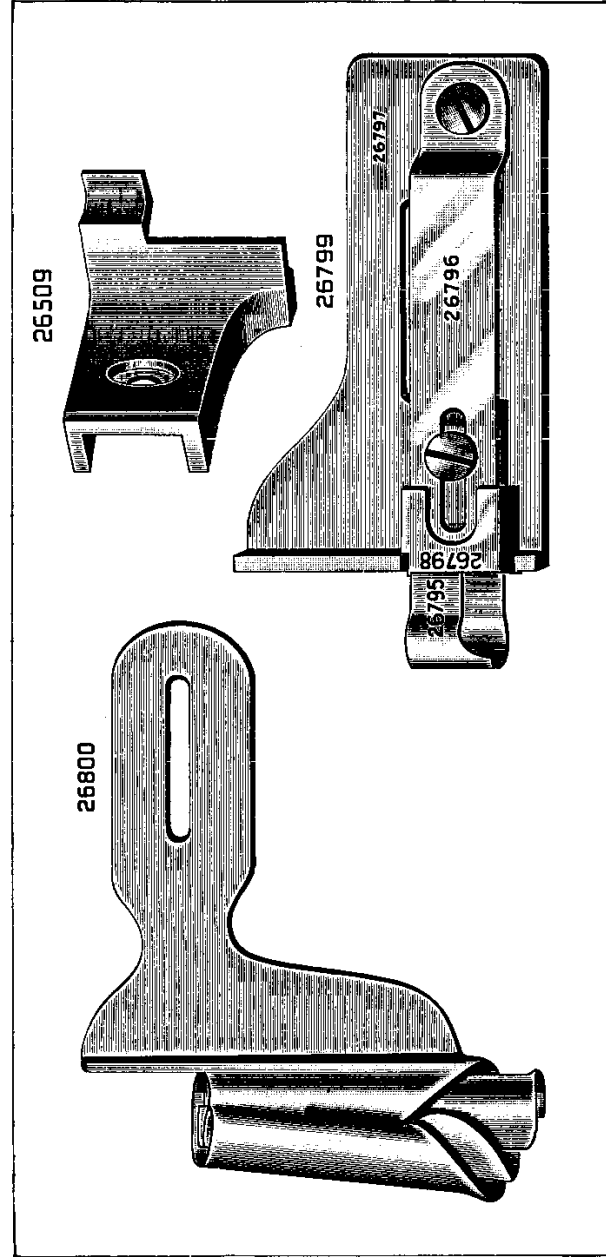

PLATE 4414—FULL SIZE

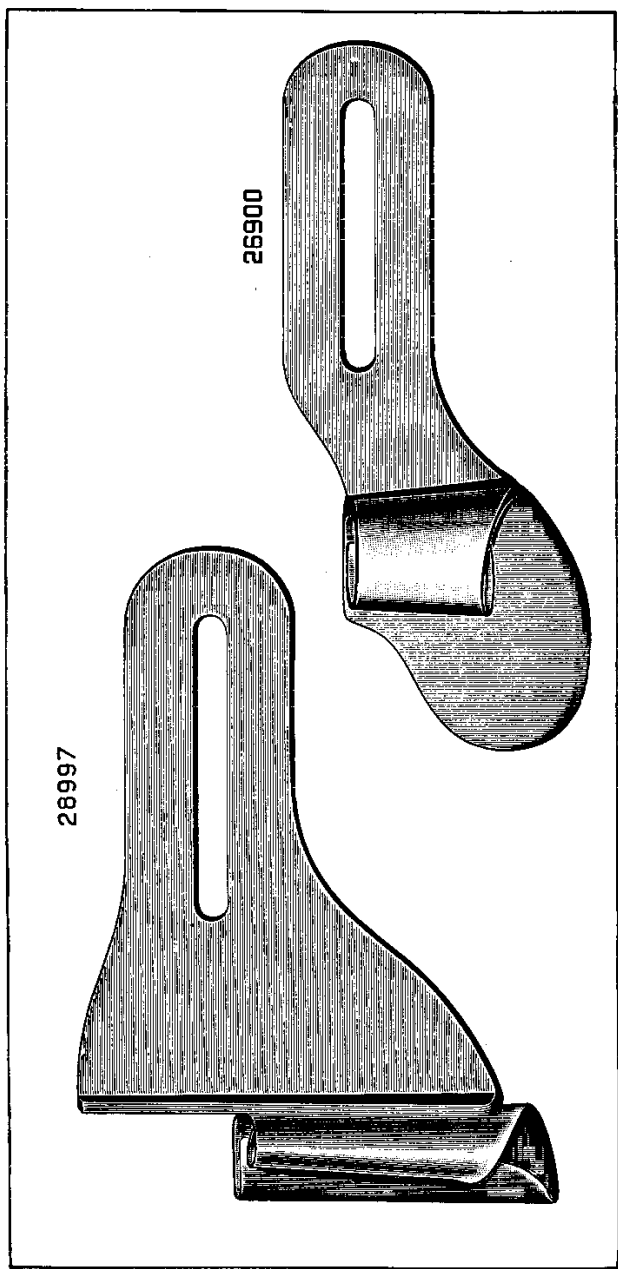

PLATE 4415—FULL SIZE

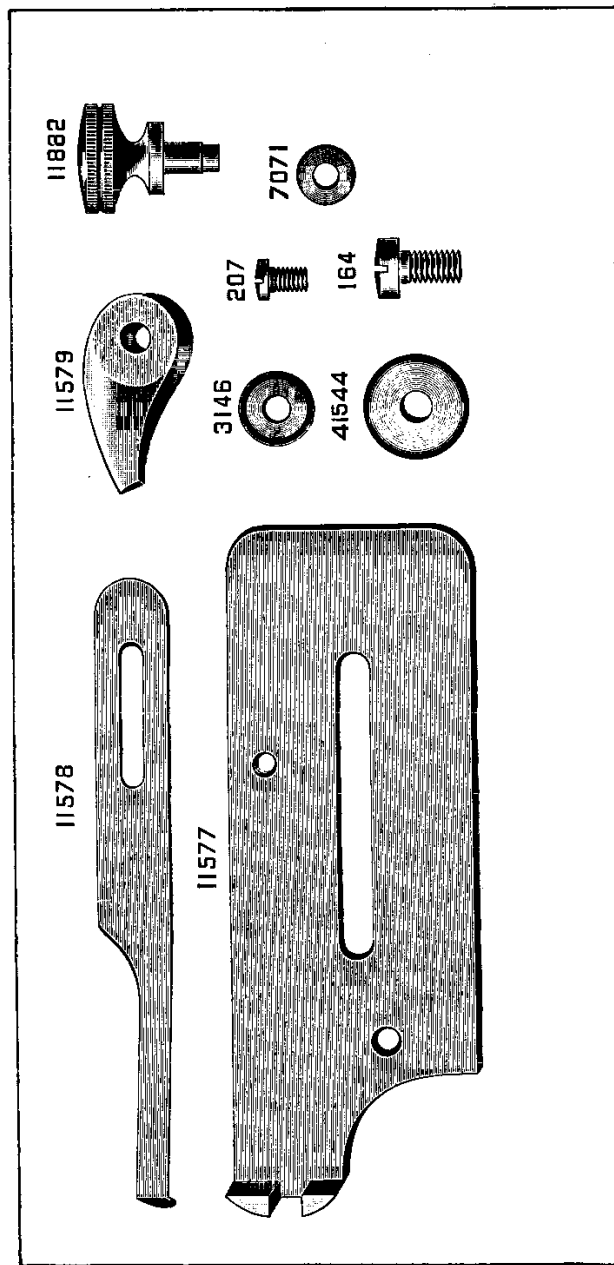

PLATE 4416—FULL SIZE

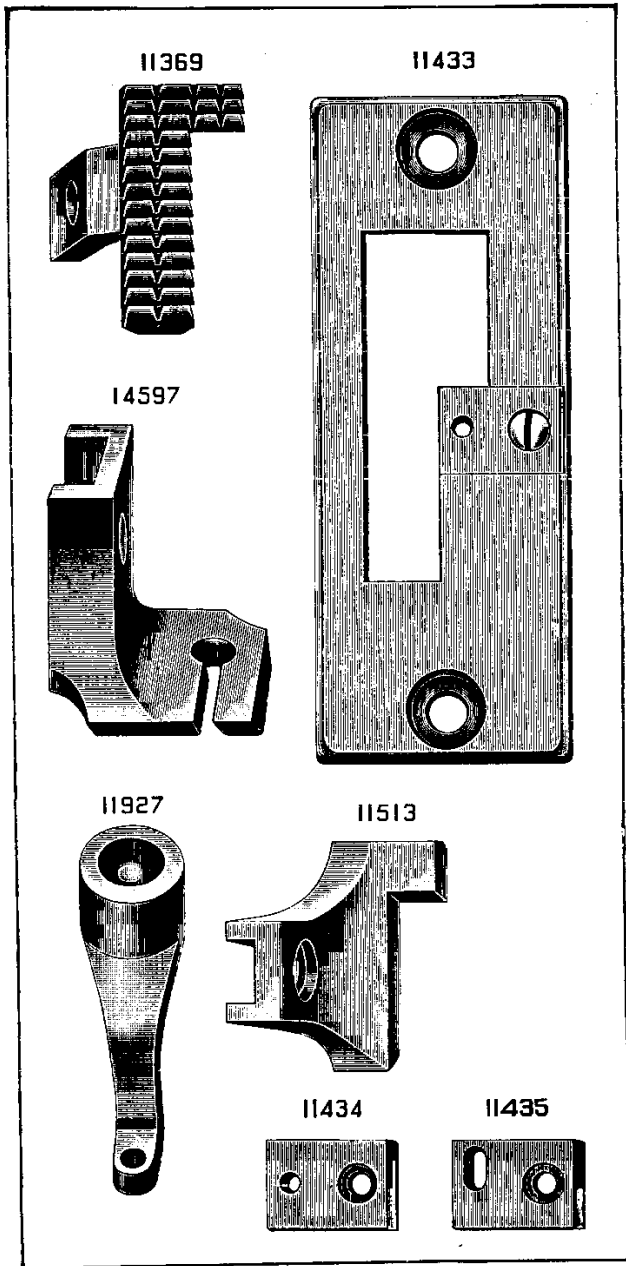

PLATE 4417—ONE-HALF SIZE

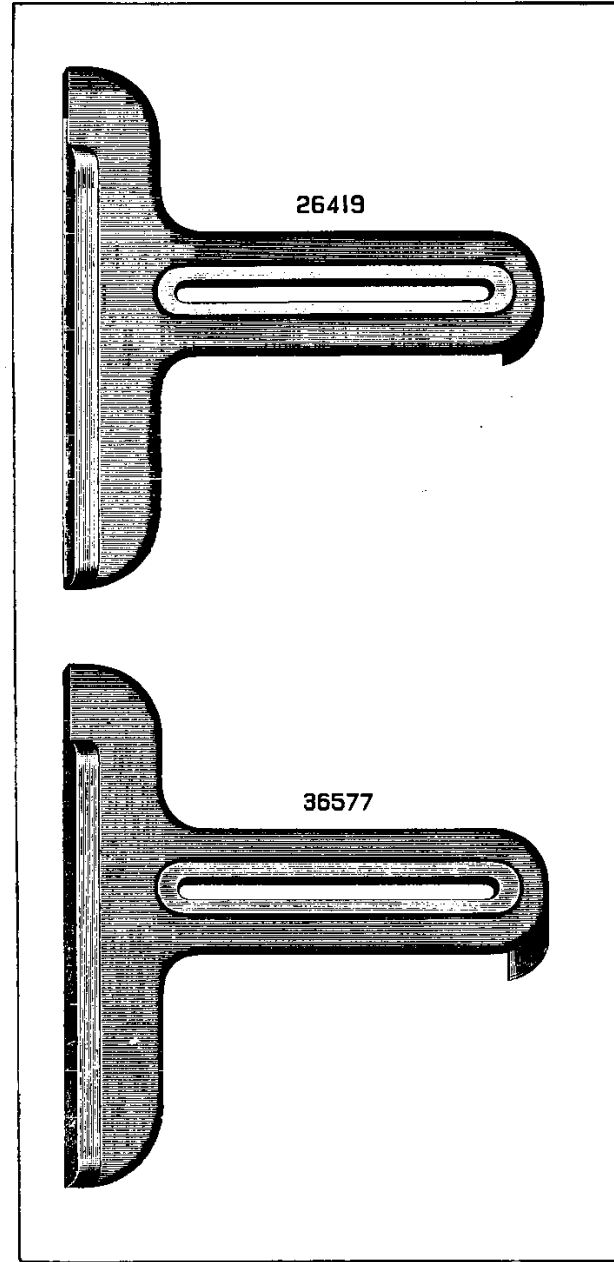

PLATE 4420—ONE-FOURTH SIZE

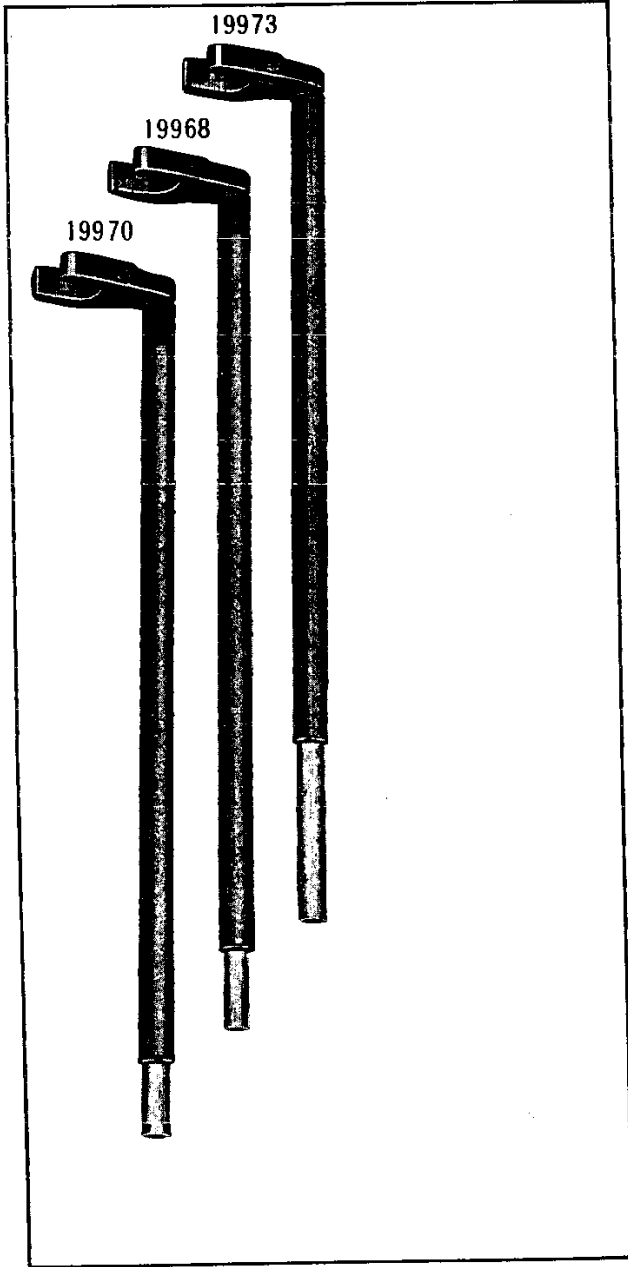
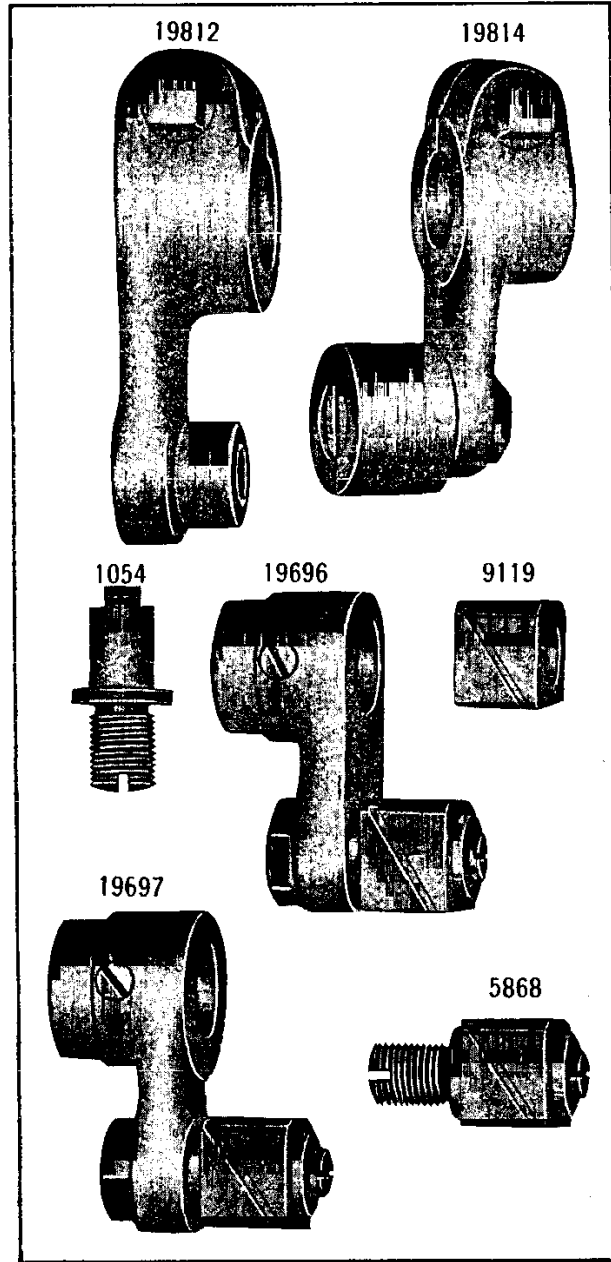

PLATE 4421—FULL SIZE



From the library of: Diamond Needle Corp

PLATE 4422—FULL SIZE

19652

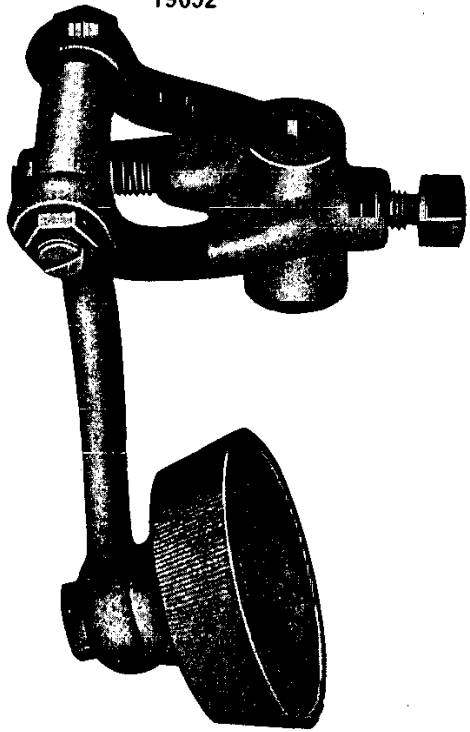
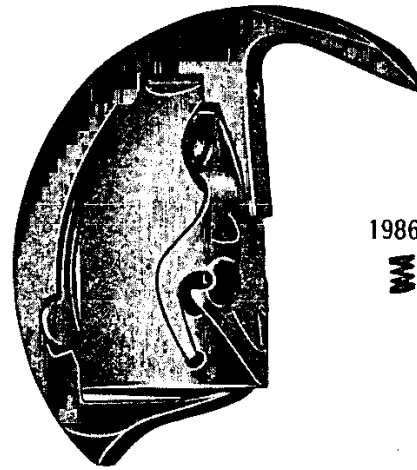

PLATE 4423—FULL SIZE

19871



19869

WM

19870

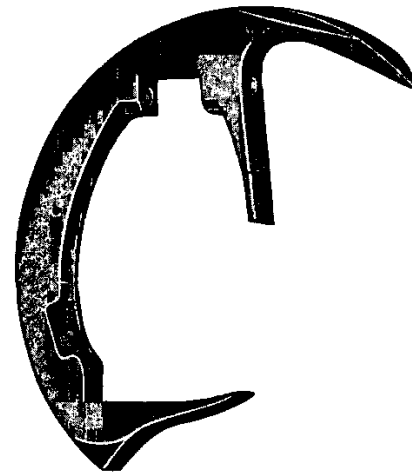
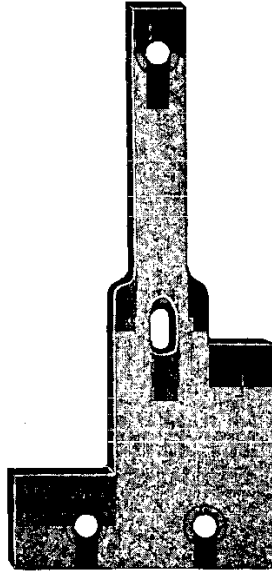
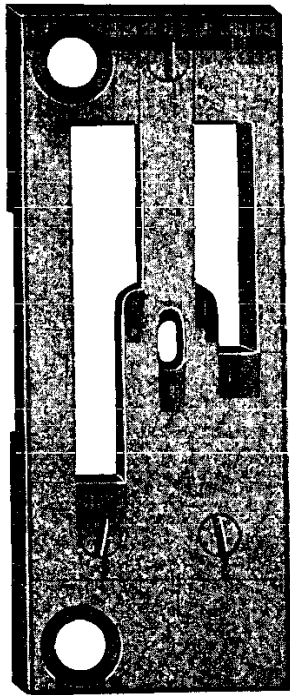

PLATE 4424—FULL SIZE

19875

19874



19872

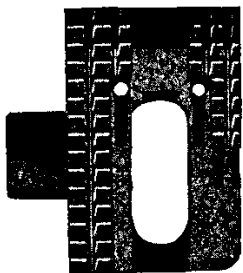
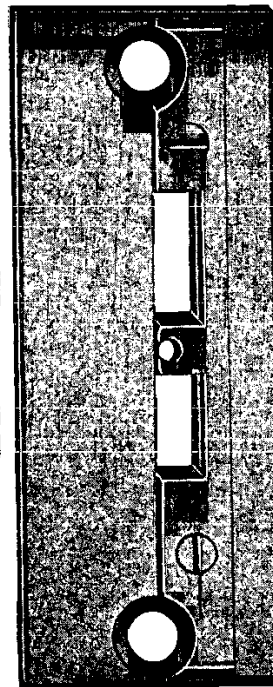

PLATE 4425—FULL SIZE

11556

11557

11521



From the library of: Diamond Needle Corp

PLATE 4426—FULL SIZE

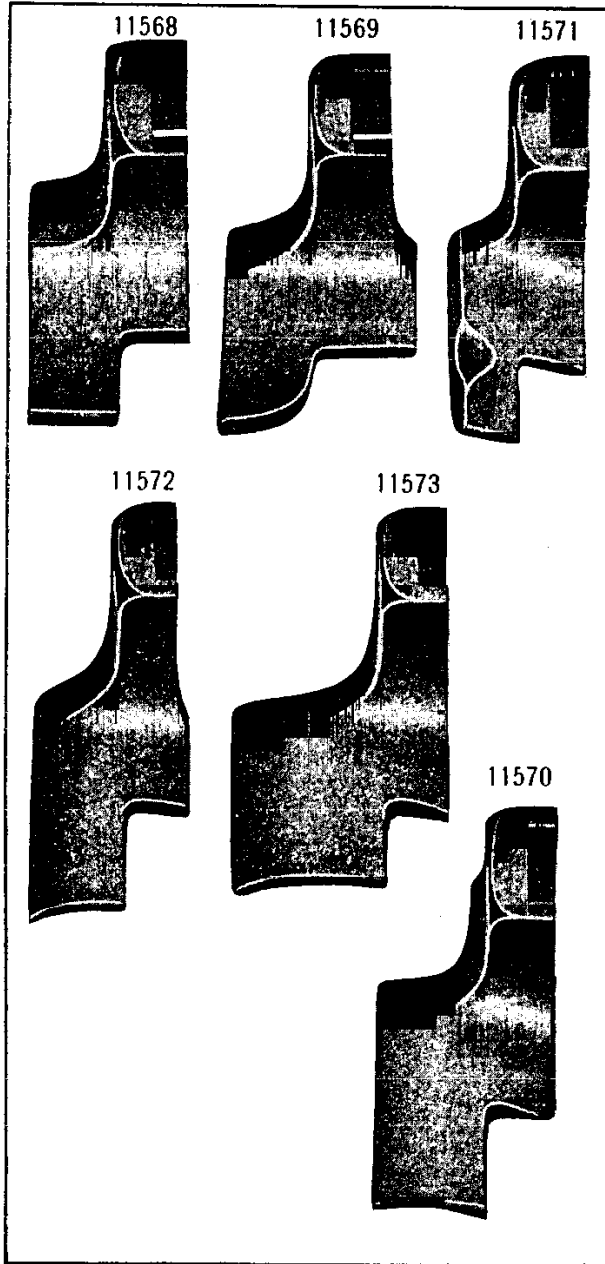
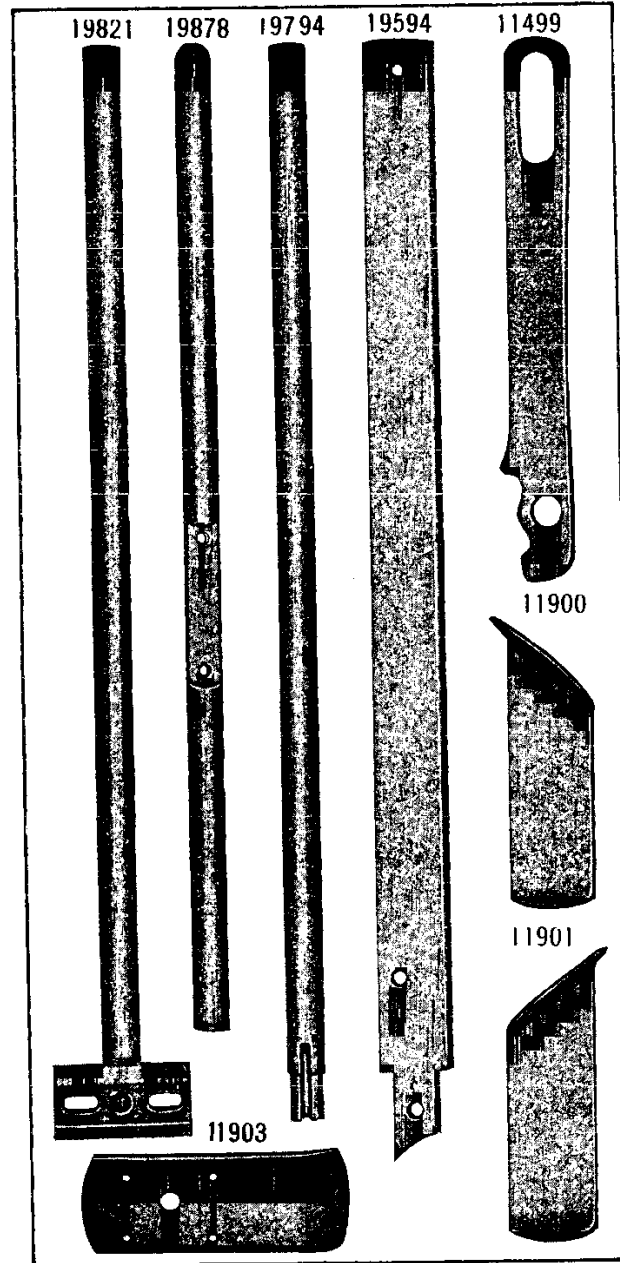

PLATE 4427—ONE-HALF SIZE



From the library of: Diamond Needle Corp

PLATE 4428—FULL SIZE

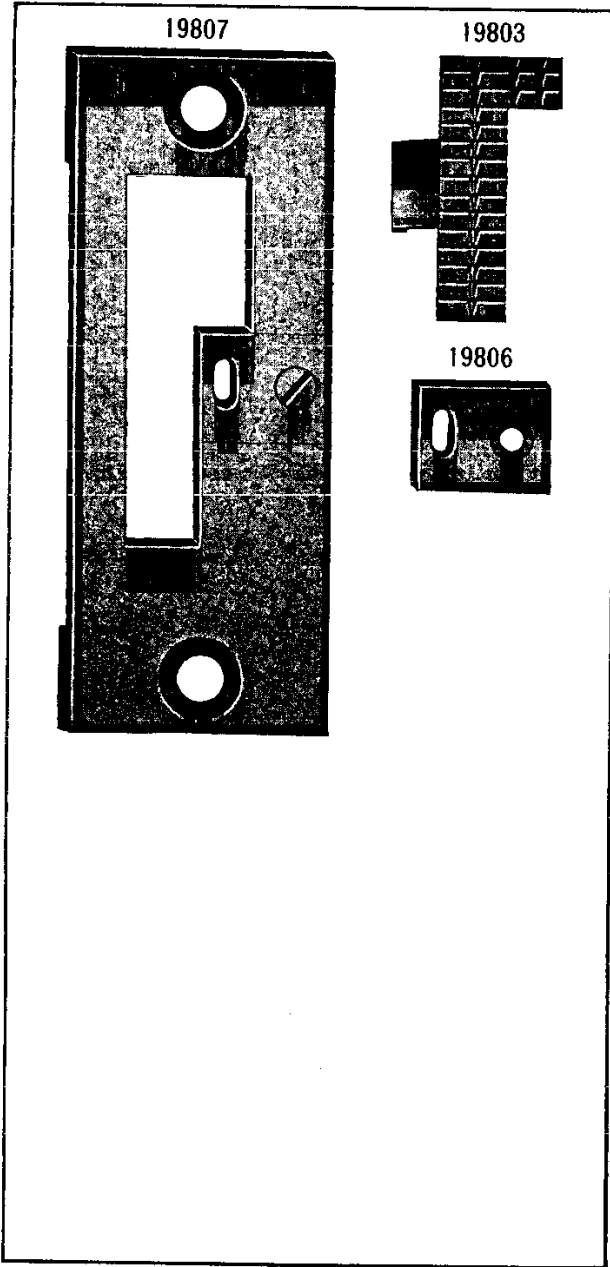

PLATE 4429—FULL SIZE

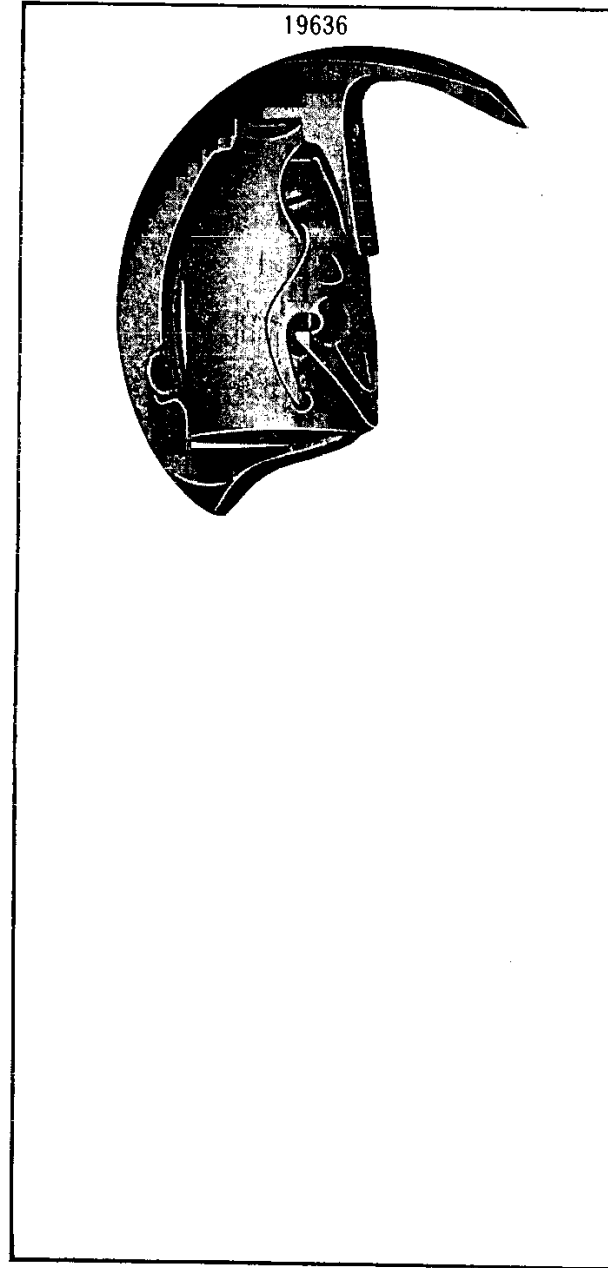

PLATE 4430—ONE-FOURTH SIZE

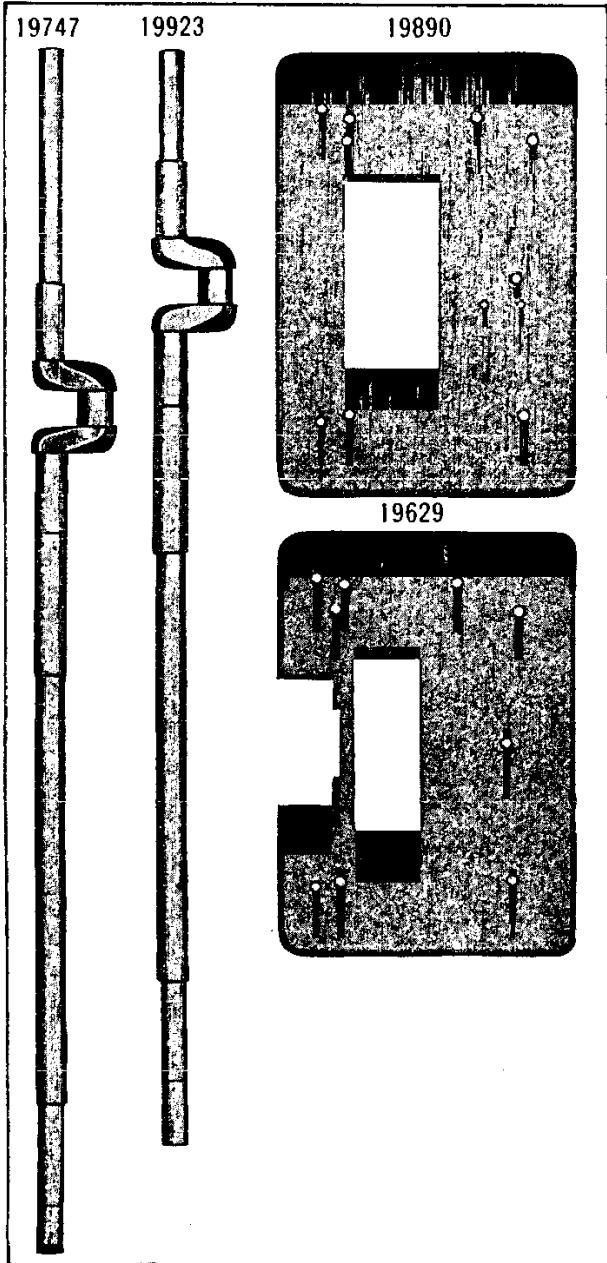

PLATE 4433—ONE-HALF SIZE

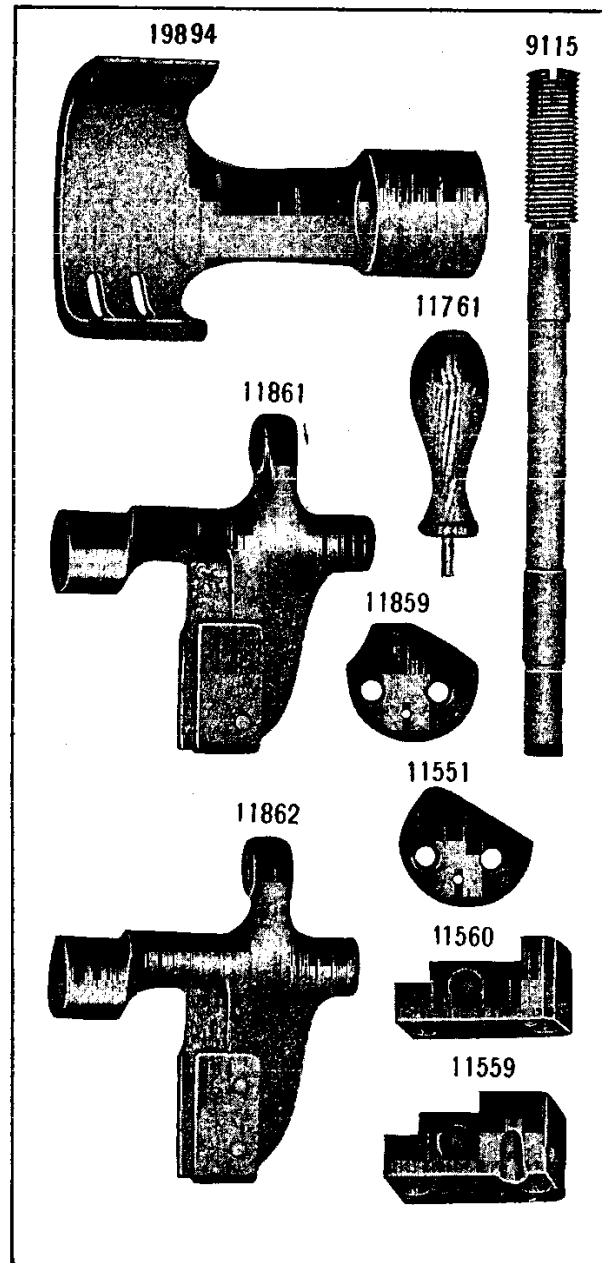

PLATE 4434—FULL SIZE

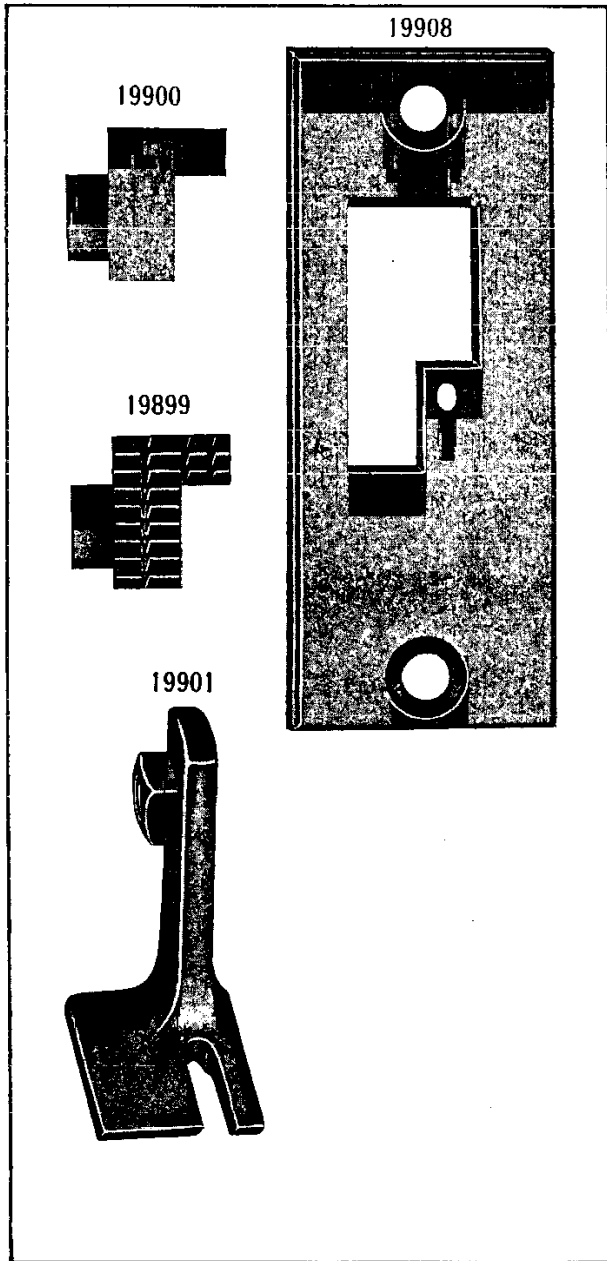

PLATE 4435—FULL SIZE

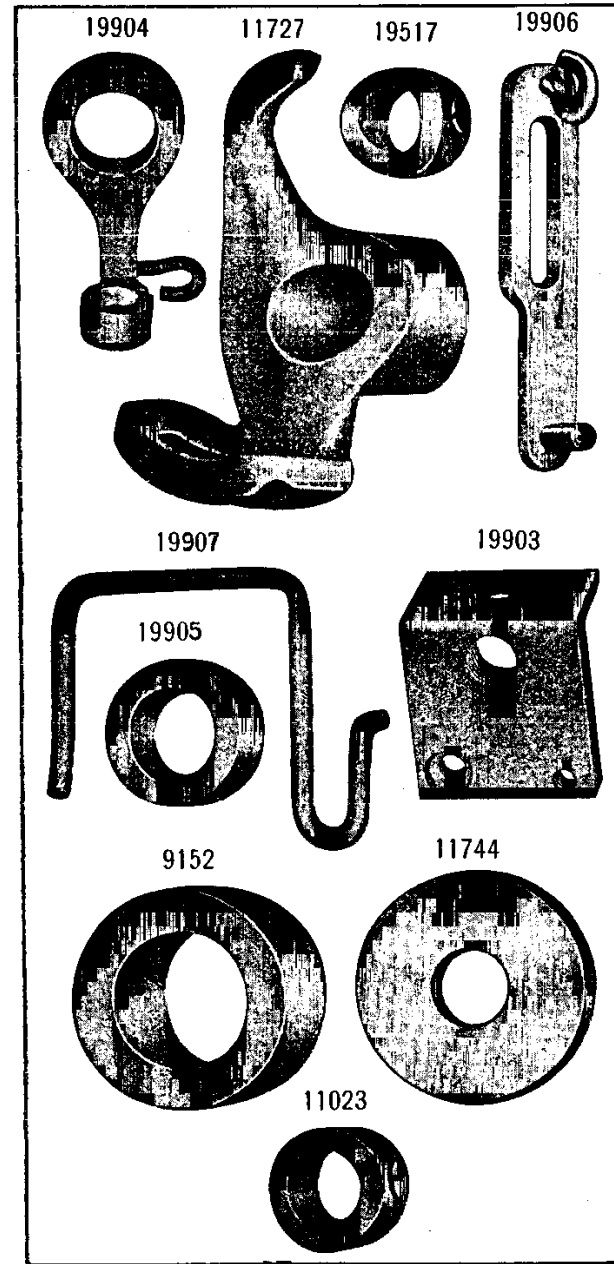
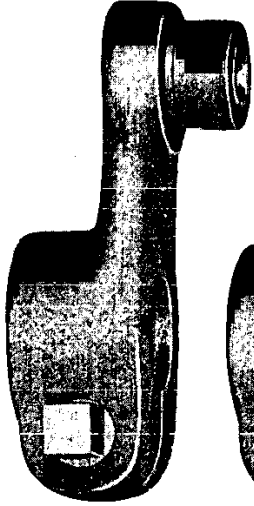
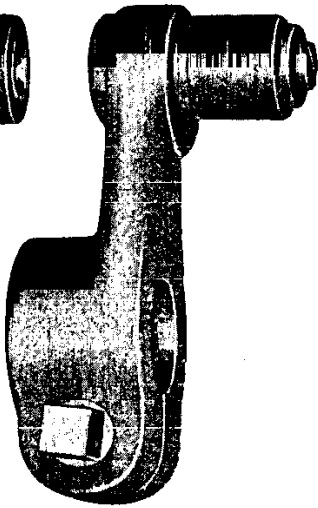

PLATE 4439—FULL SIZE

19819



19816



19837

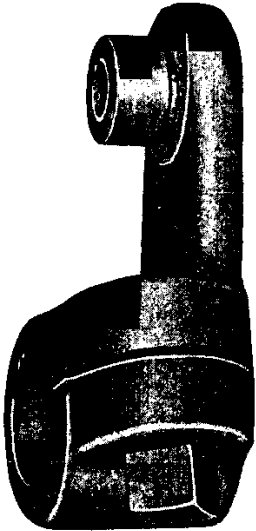
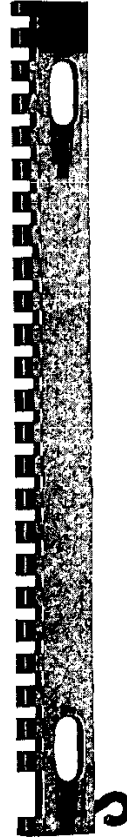

PLATE 4442—ONE-HALF SIZE

9162



9161



9159

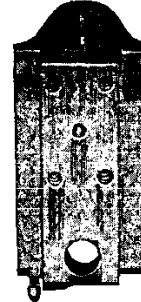

9163



7585



9160

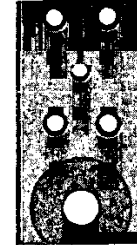

9167



PLATE 4443—FULL SIZE

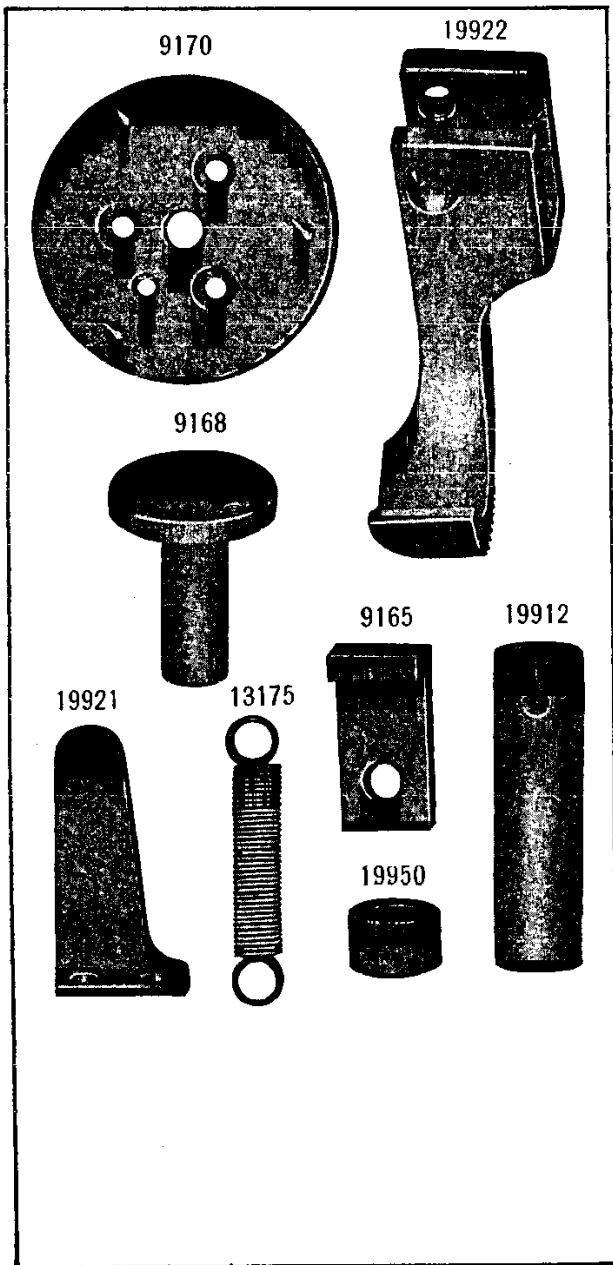
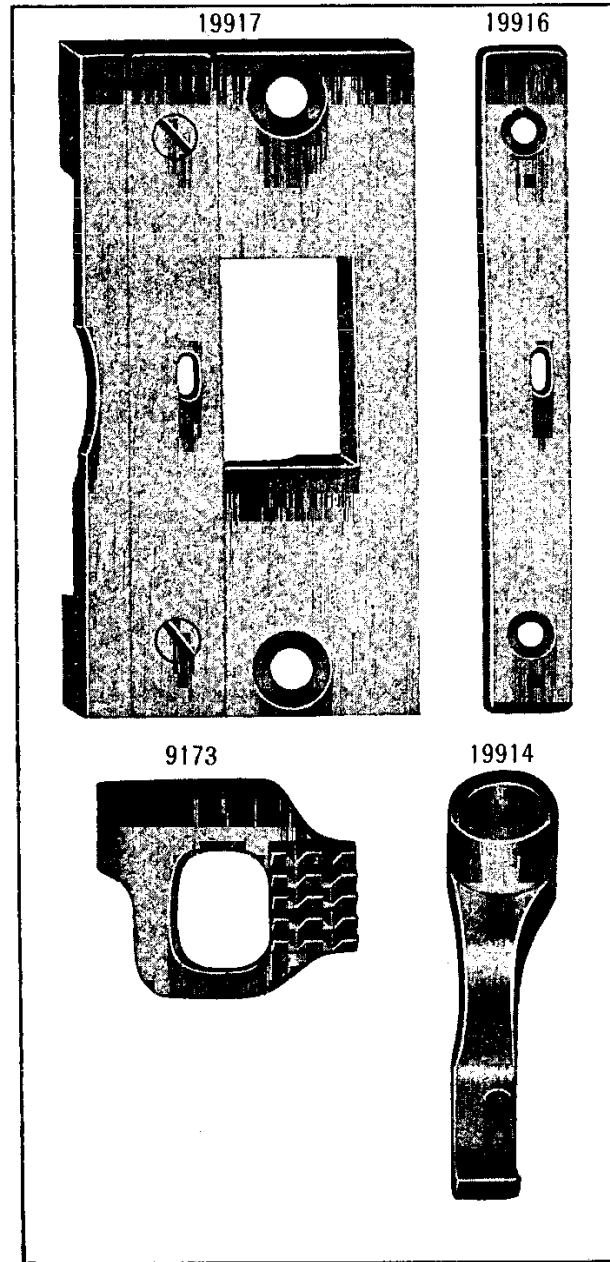

PLATE 4444—FULL SIZE



From the library of: Diamond Needle Corp

PLATE 4445—ONE-HALF SIZE

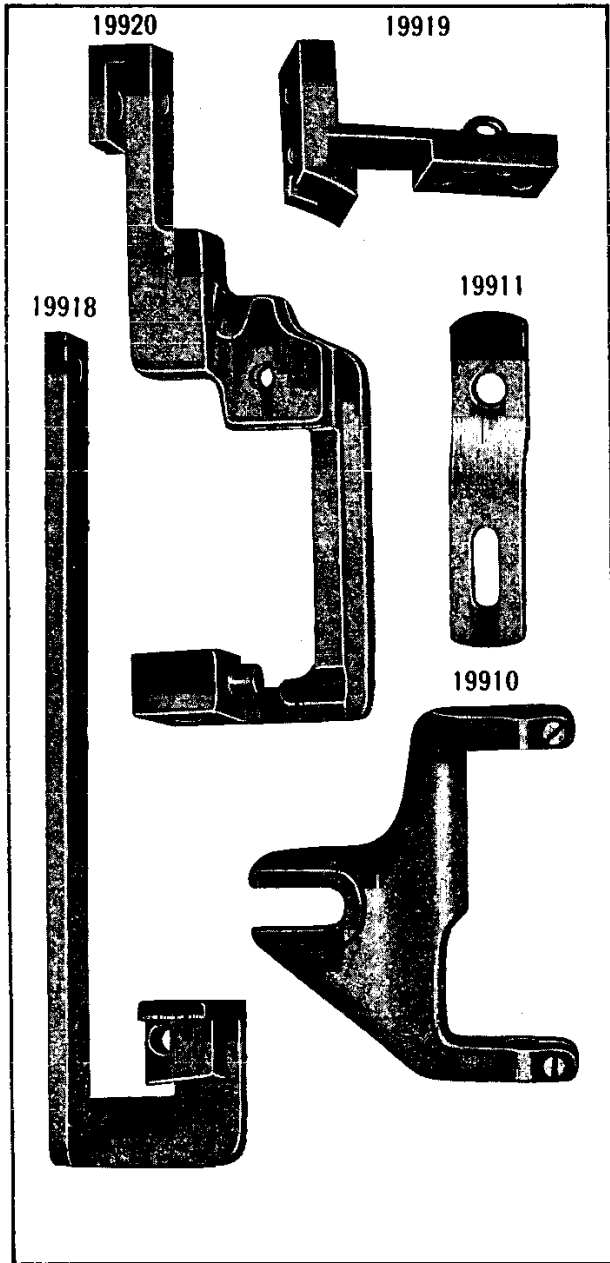

PLATE 4446—ONE-HALF SIZE

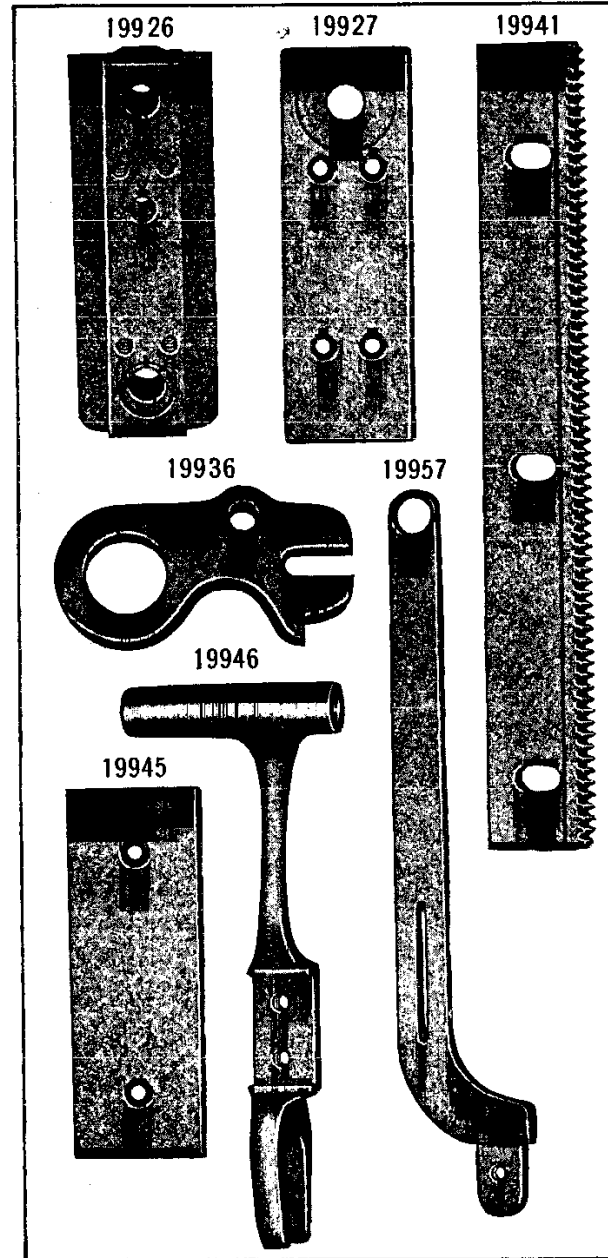

PLATE 4447—FULL SIZE

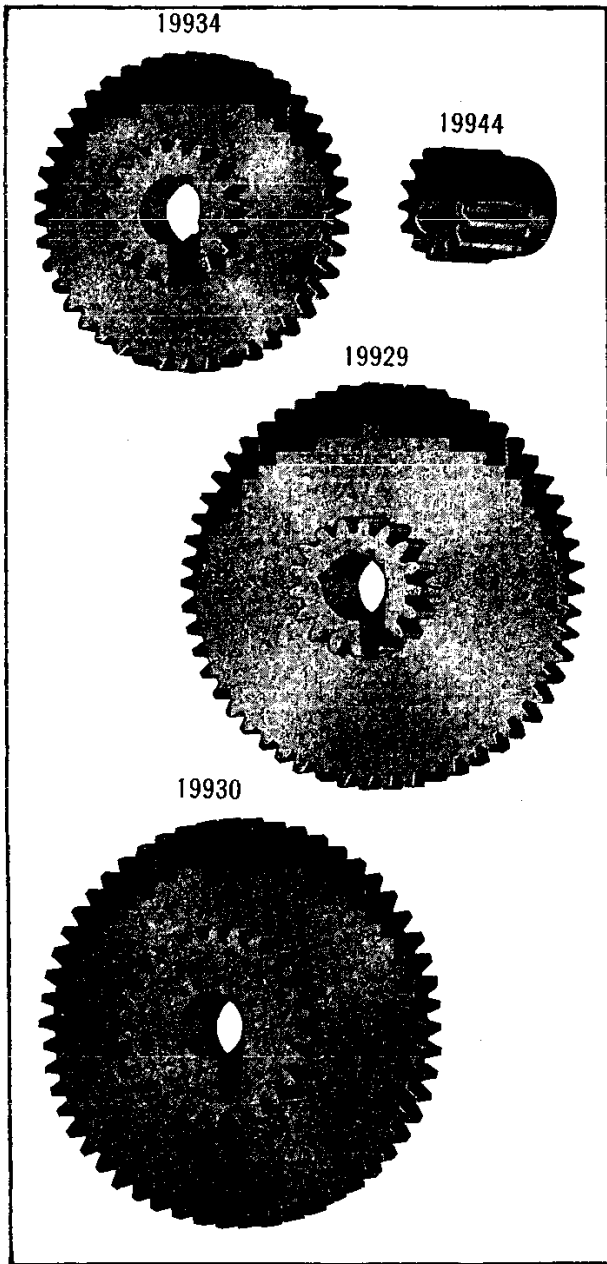

PLATE 4448—FULL SIZE

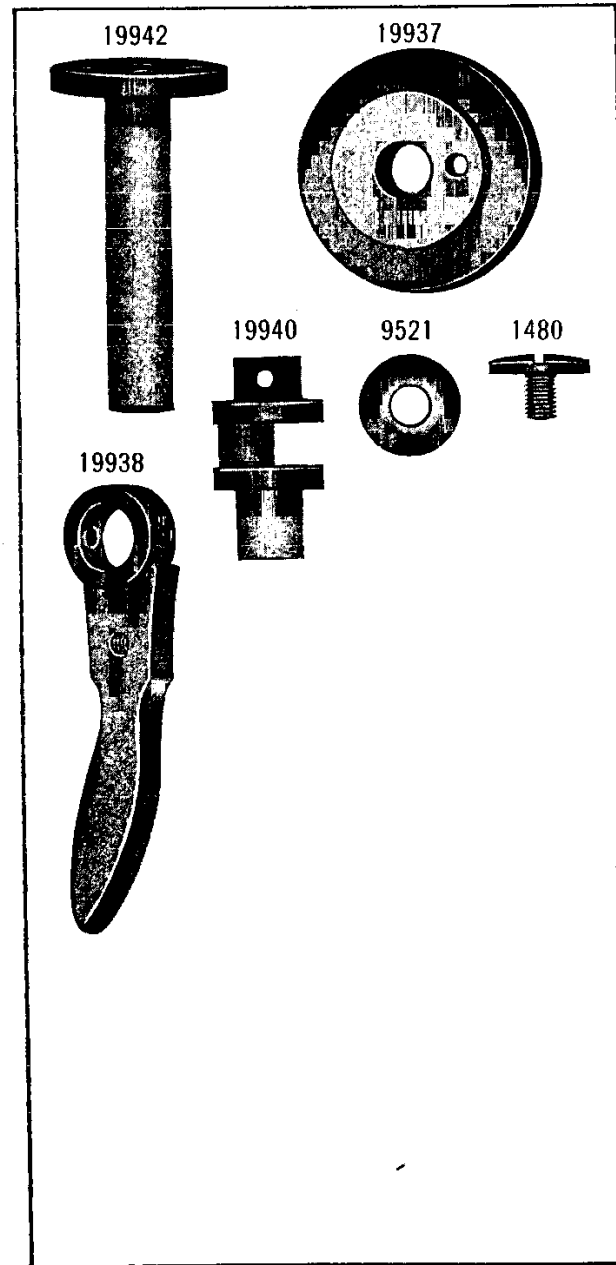
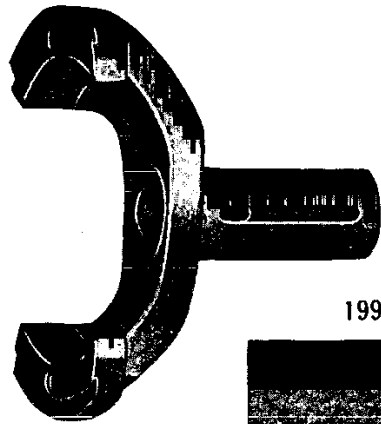

PLATE 4450—ONE-HALF SIZE

19952



19953

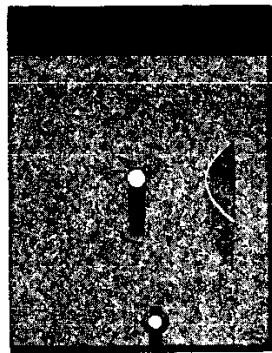

PLATE 4451—FULL SIZE

50206

50205

660

50204

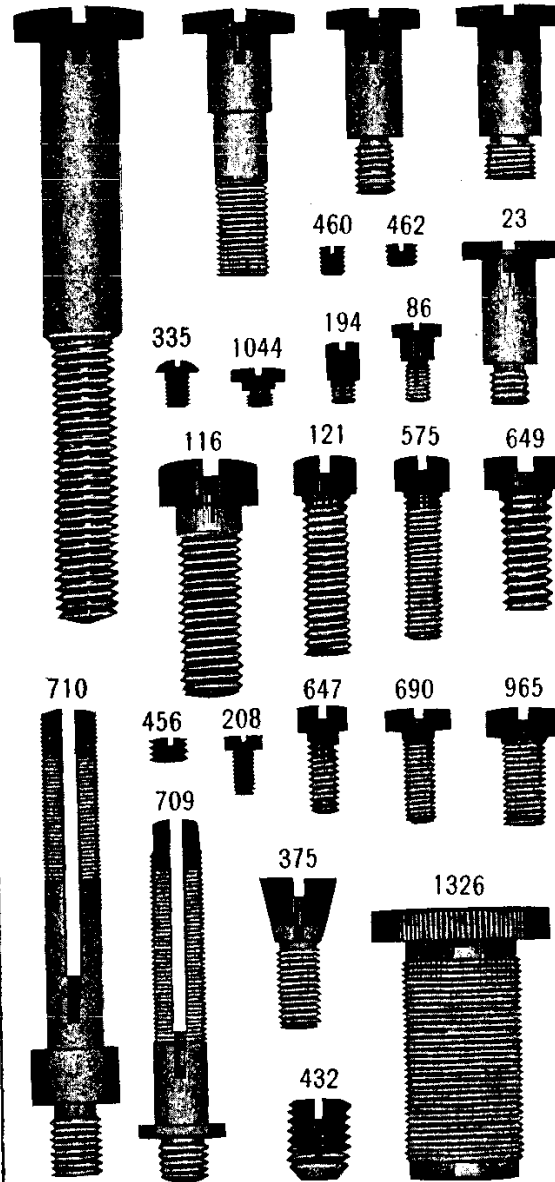

PLATE 4452—FULL SIZE

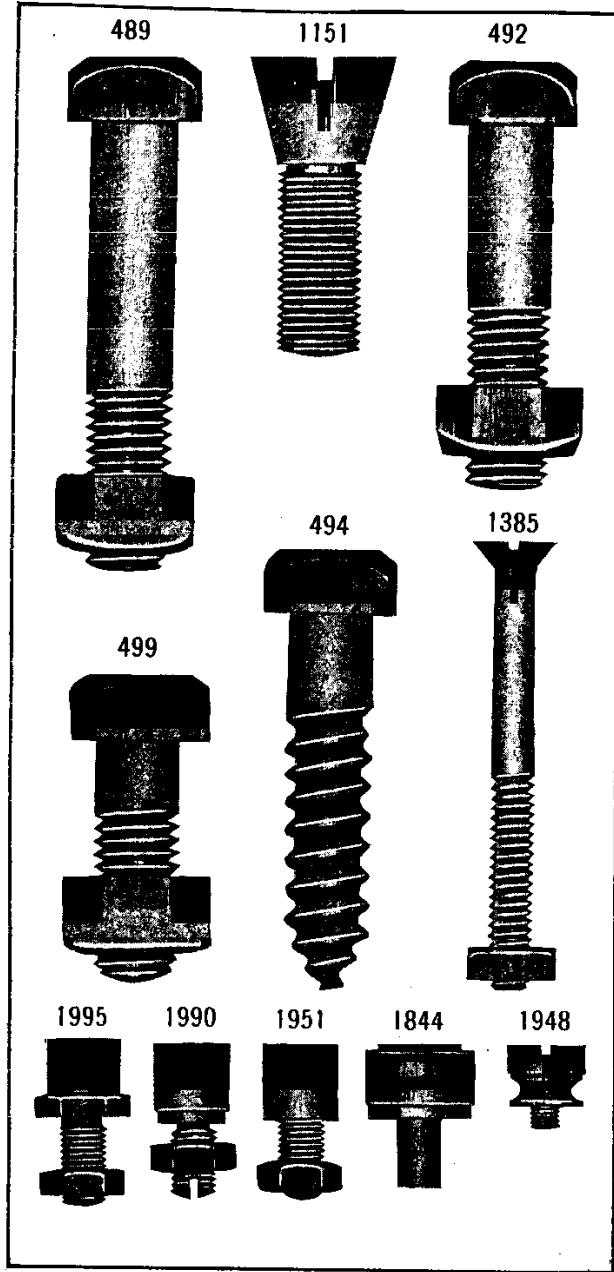

PLATE 4453—FULL SIZE

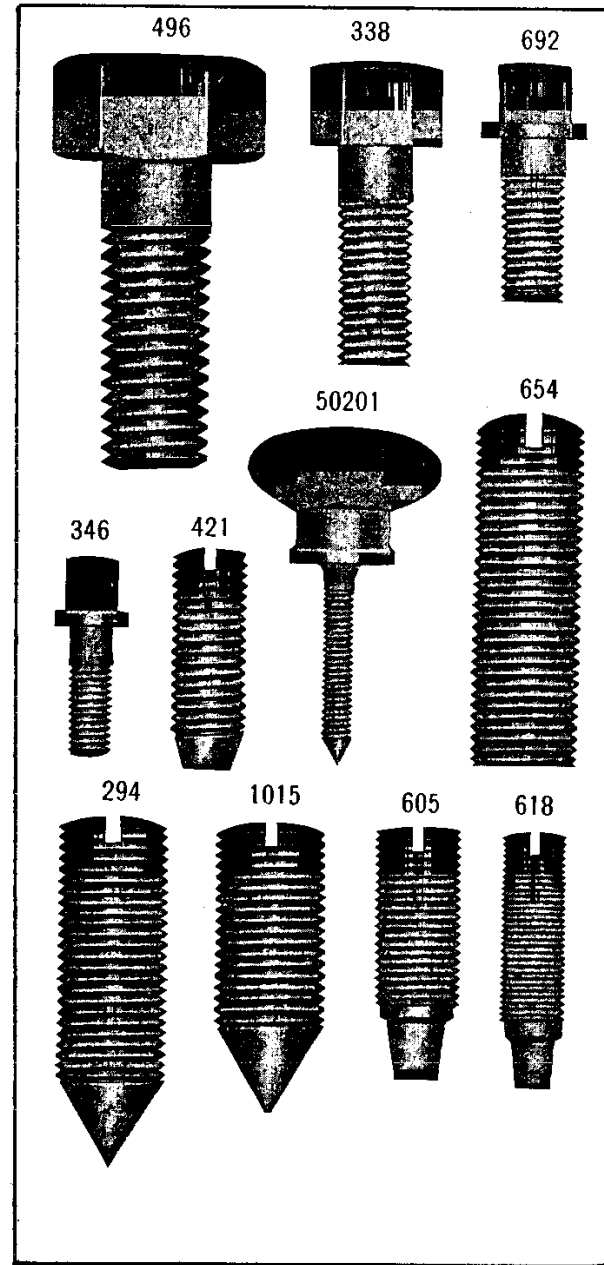

PLATE 4454—FULL SIZE

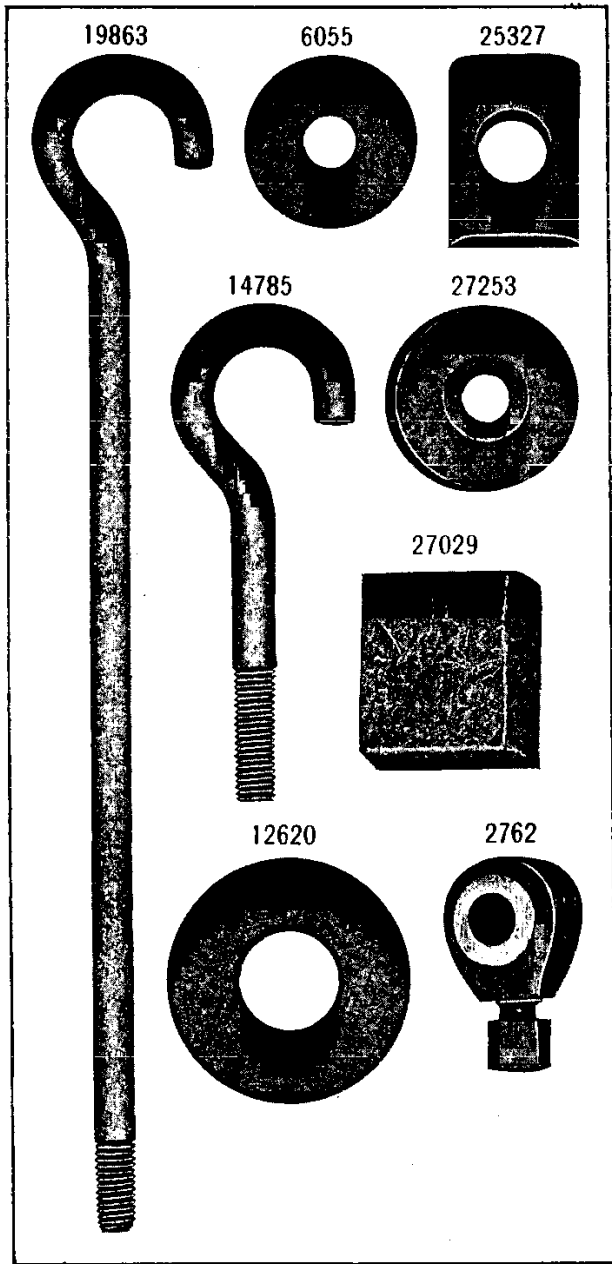

PLATE 4455—FULL SIZE

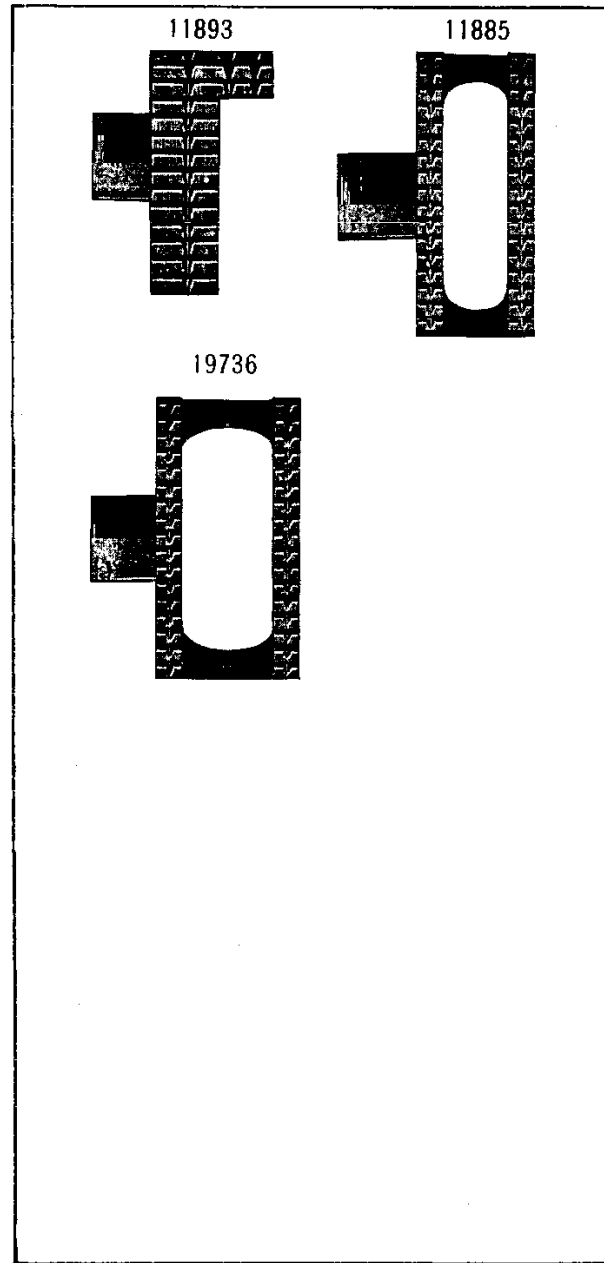

PLATE 4457—ONE-HALF SIZE

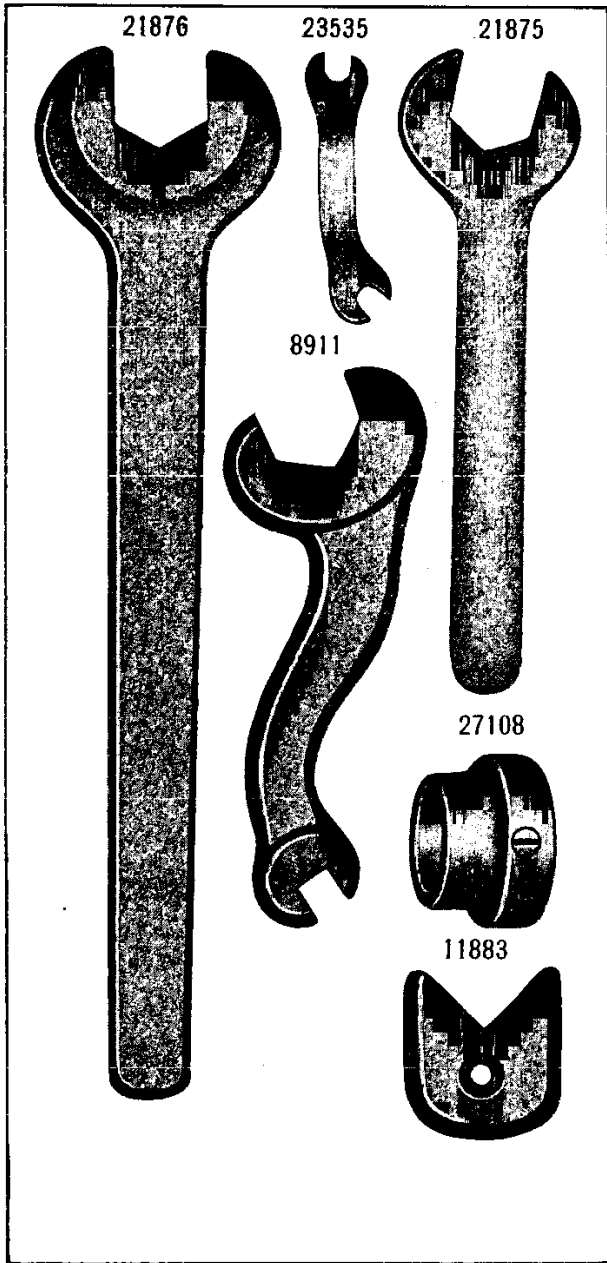

PLATE 4480—ONE-NINTH SIZE

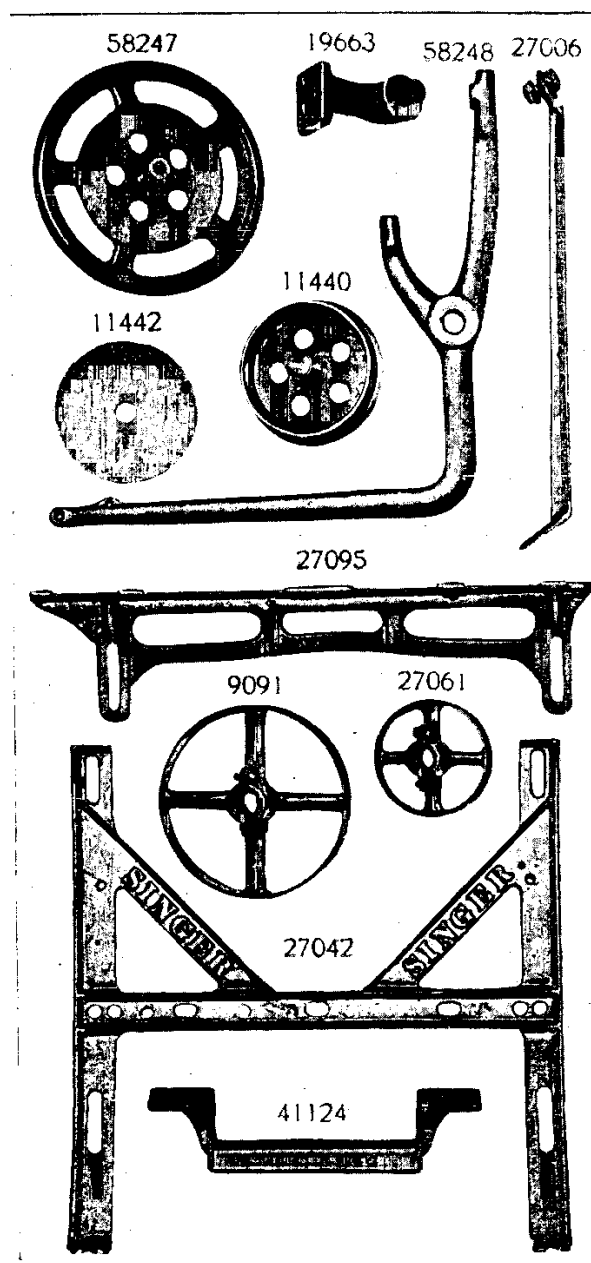

PLATE 4484—ONE-HALF SIZE

23535 120344 8909 26026 11831

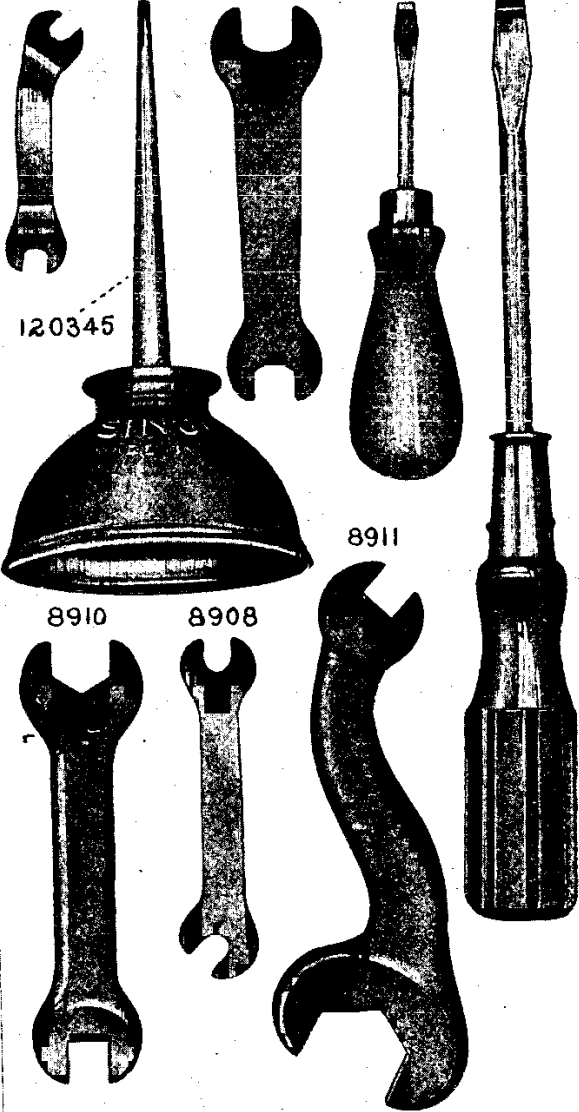

PLATE 4485—ONE-HALF SIZE

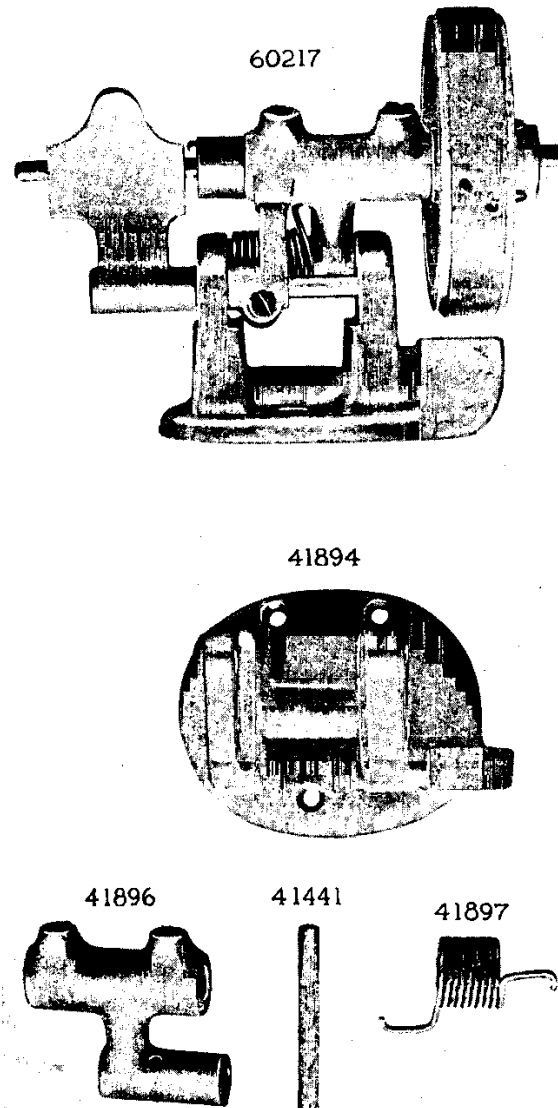

PLATE 4486—ONE-HALF SIZE

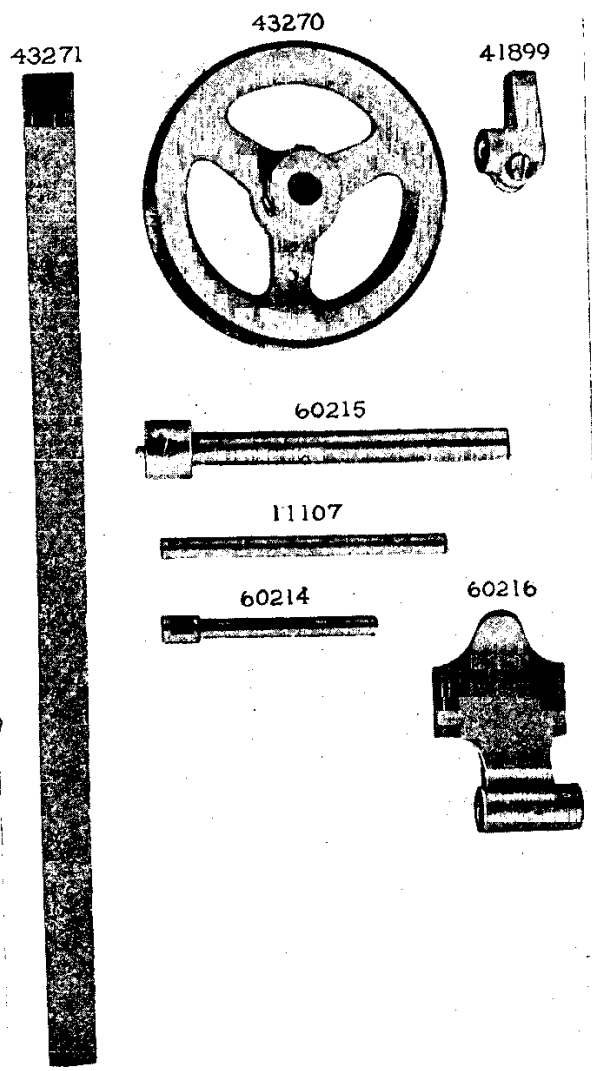
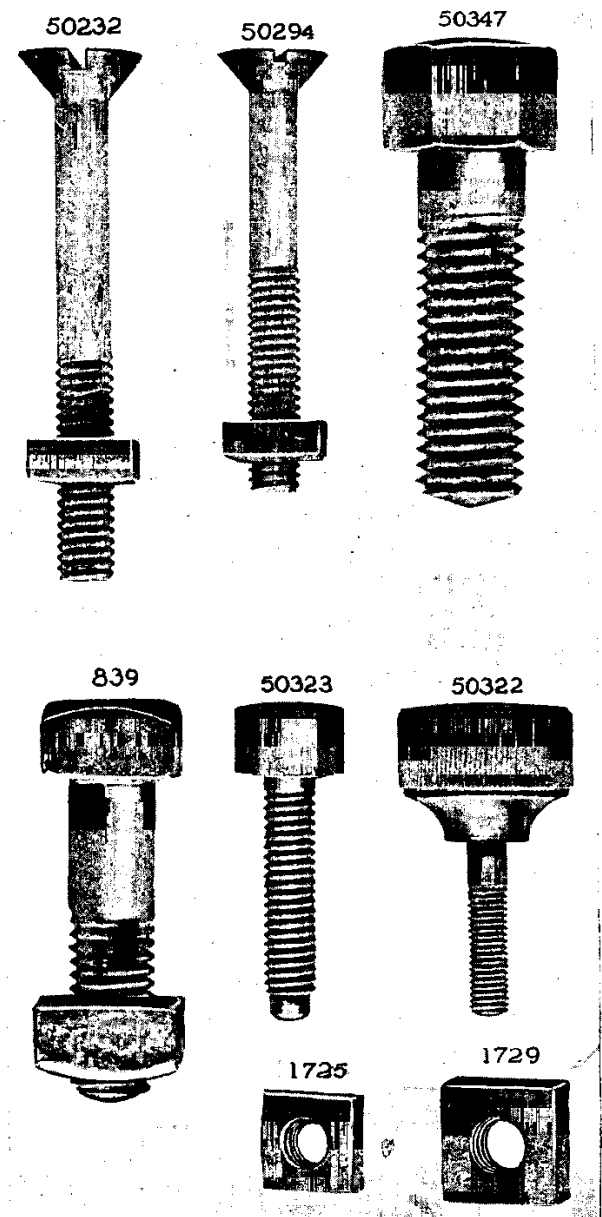

PLATE 4489—FULL SIZE



From the library of: Diamond Needle Corp

PLATE 4490—ONE-FOURTH SIZE

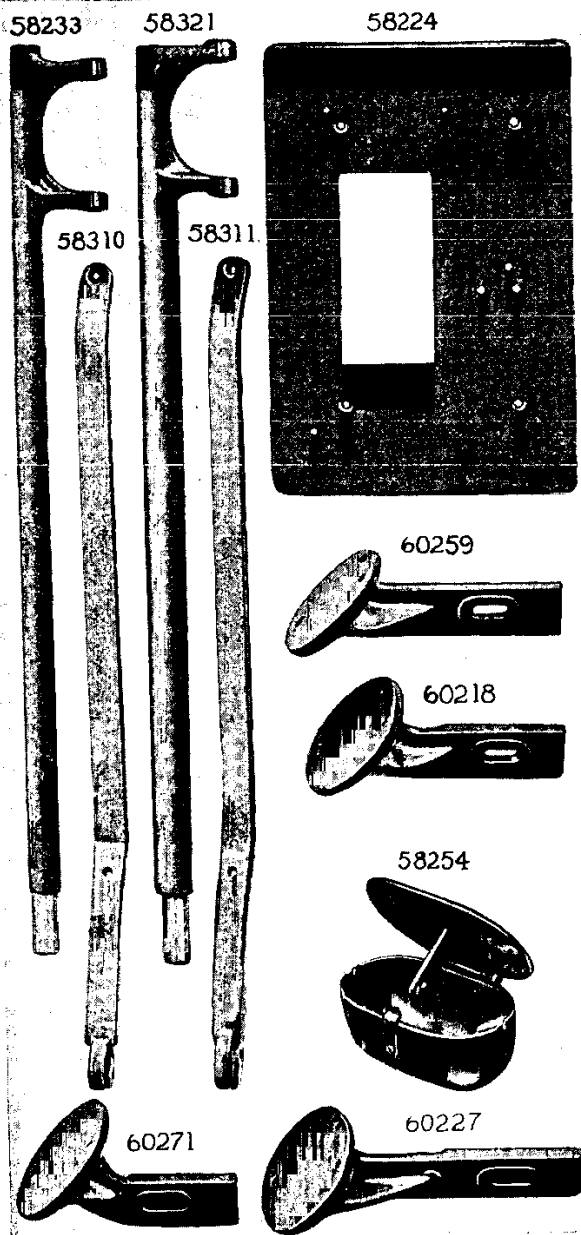
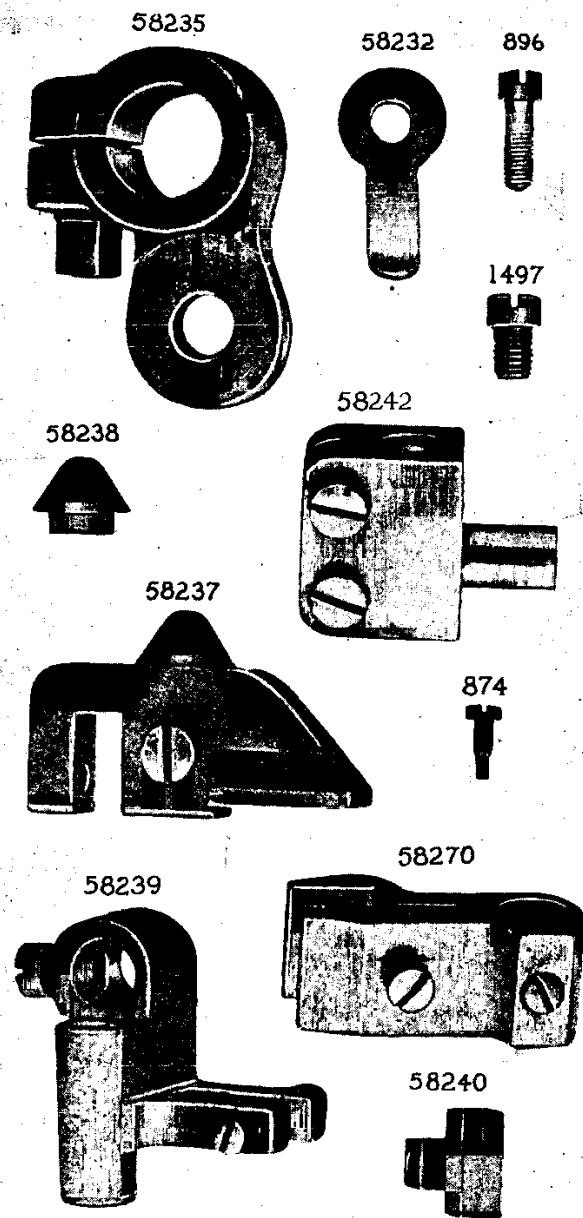

PLATE 4491—FULL SIZE



From the library of: Diamond Needle Corp

PLATE 4492—FULL SIZE

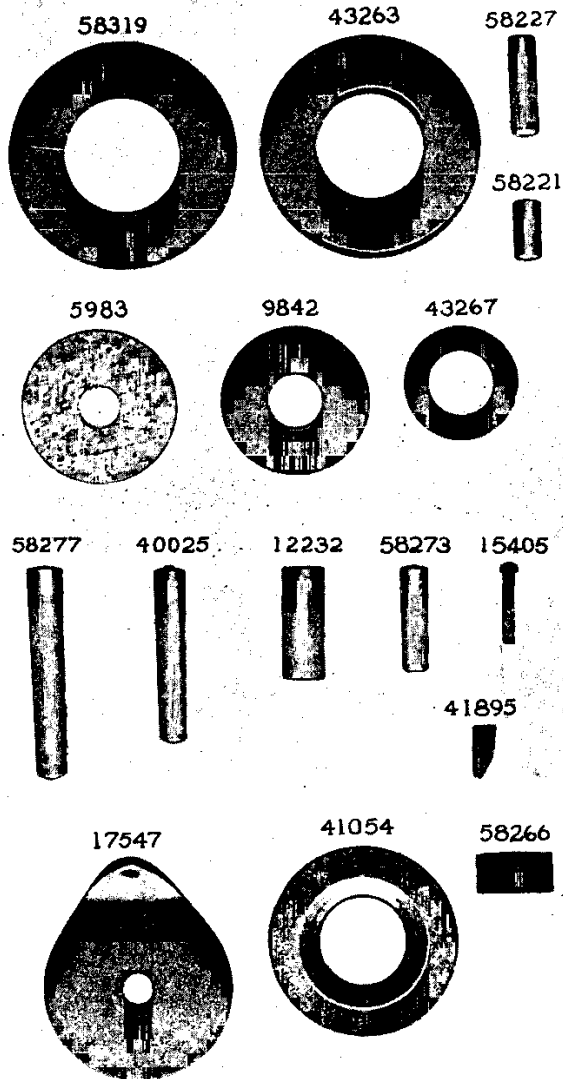

PLATE 4493—ONE-HALF SIZE

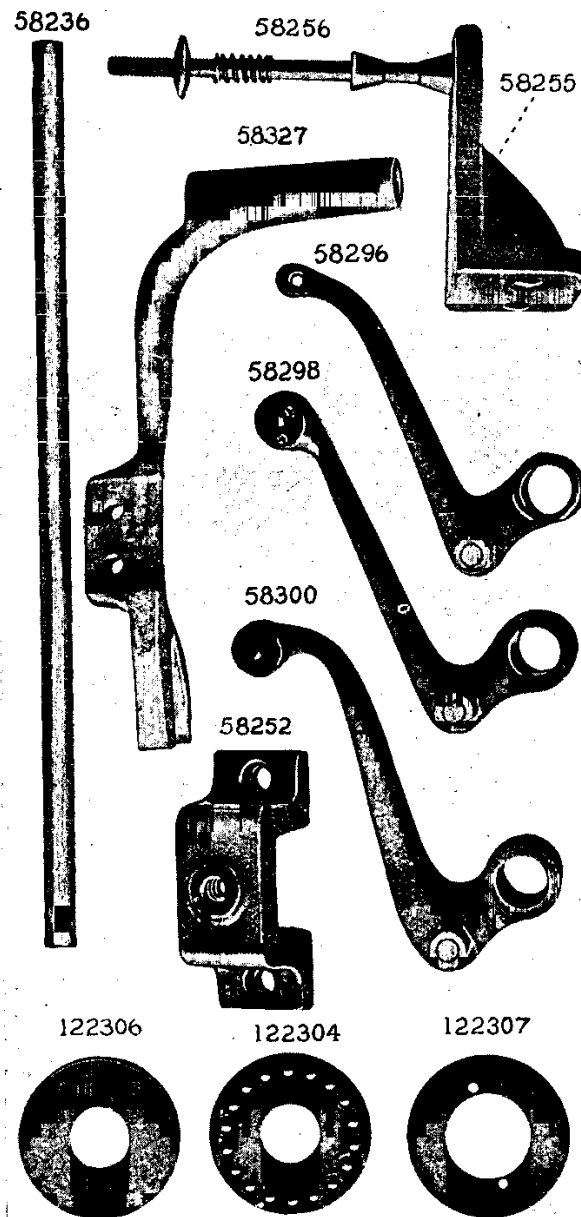

PLATE 4494—FULL SIZE

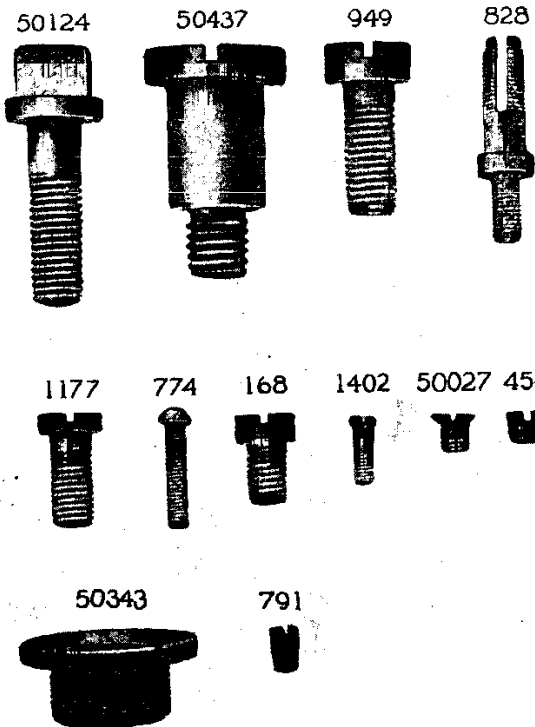

PLATE 4495—ONE-FOURTH SIZE

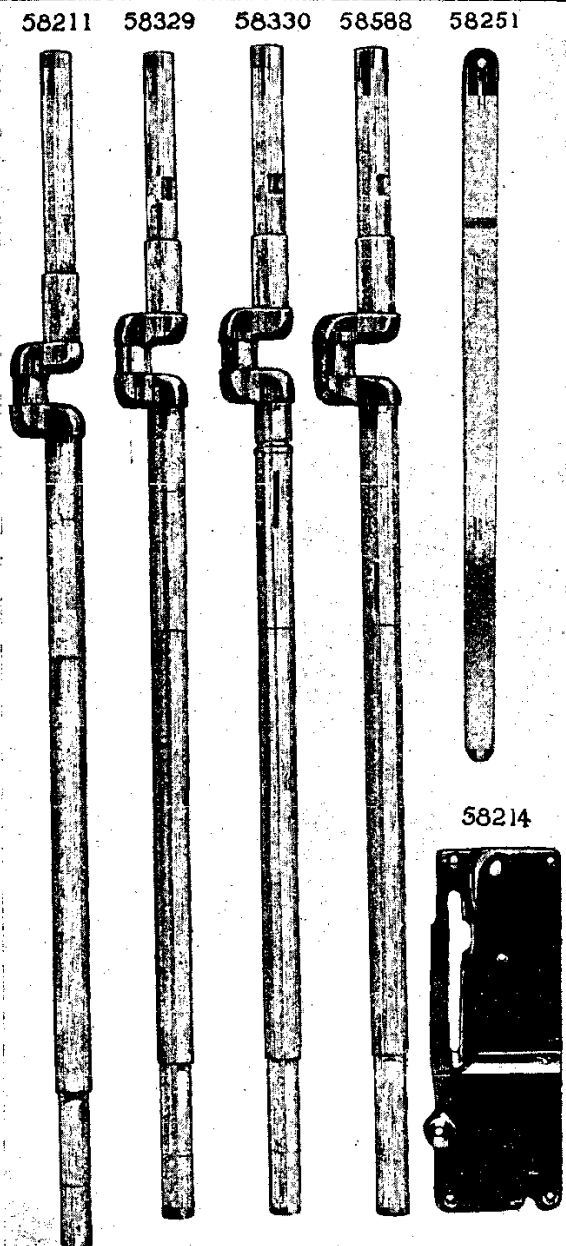

PLATE 4496—ONE-EIGHTH SIZE

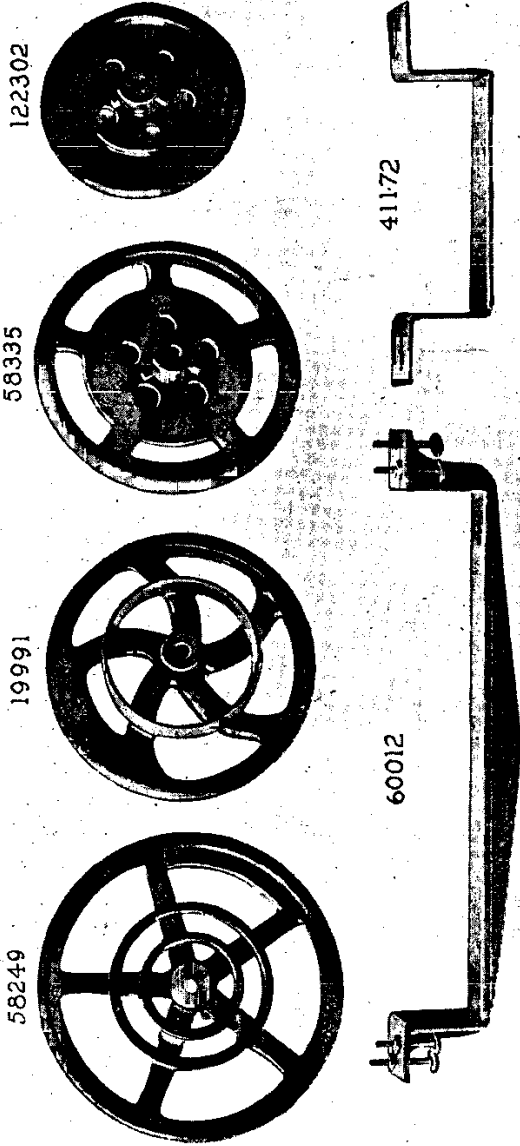

PLATE 4497—ONE-FOURTH SIZE

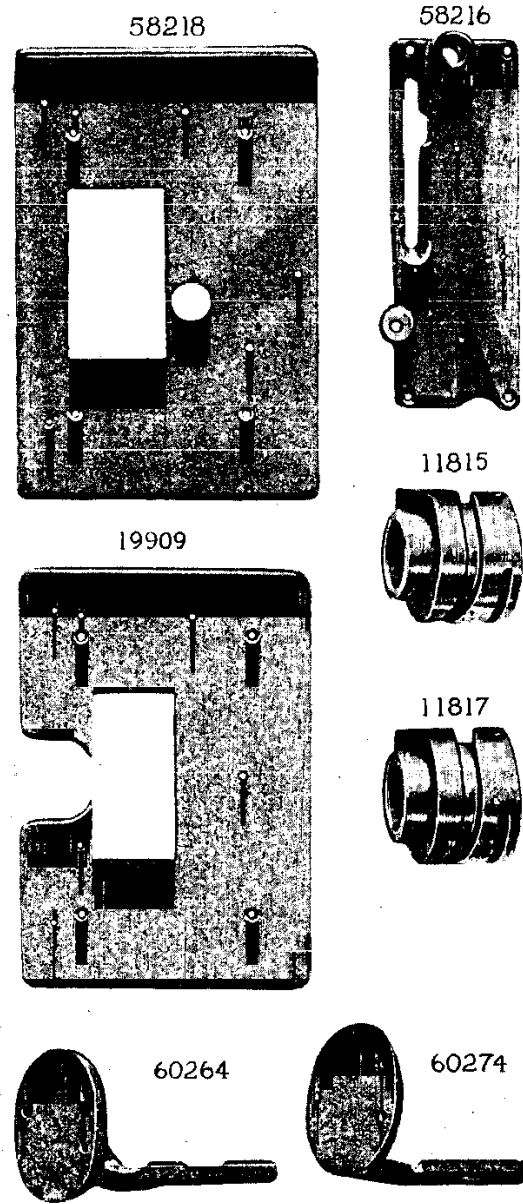

PLATE 4498—FULL SIZE

58328

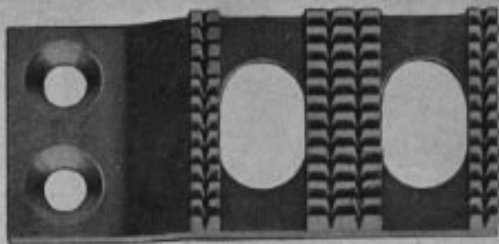
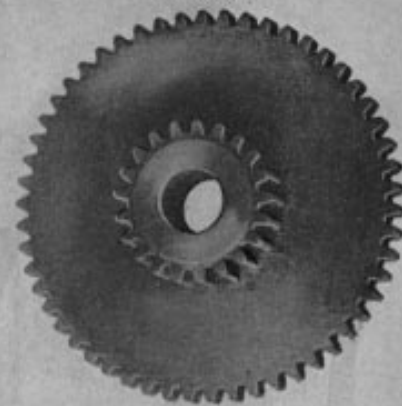

PLATE 4499—FULL SIZE

58325



58795



58279



58280



58281



50166



PLATE 6029—FULL SIZE

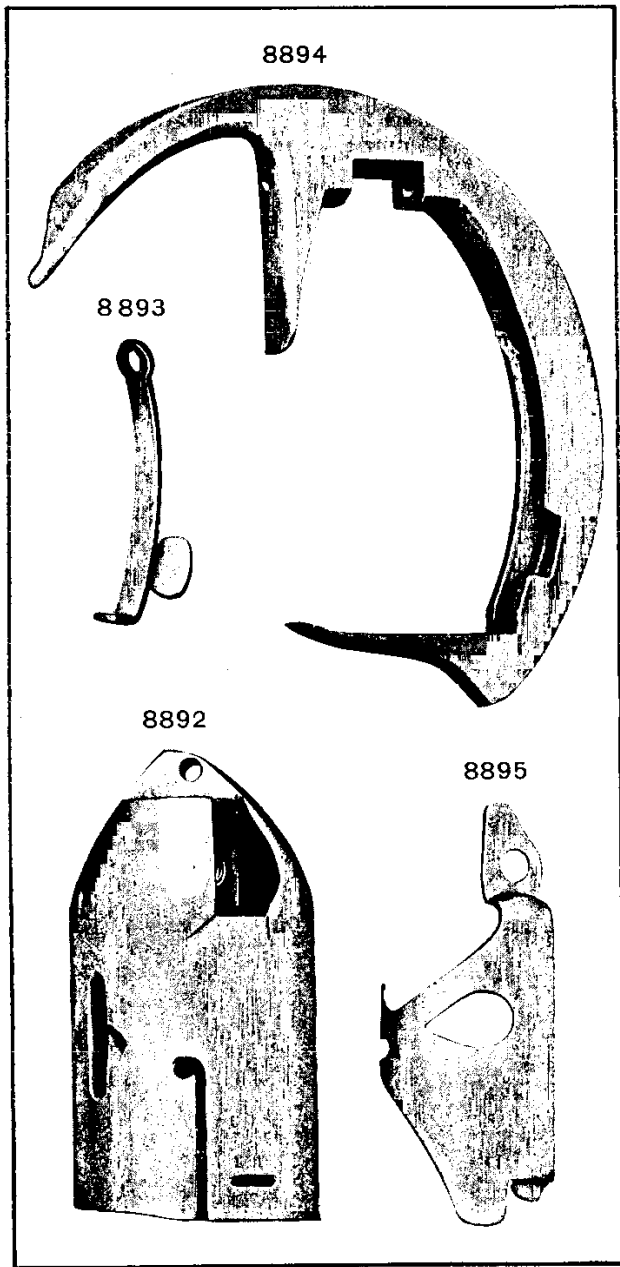

PLATE 6781—ONE-HALF SIZE

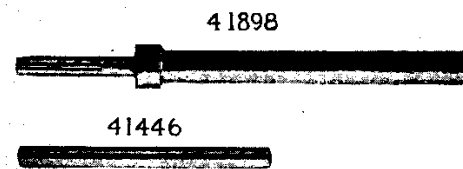
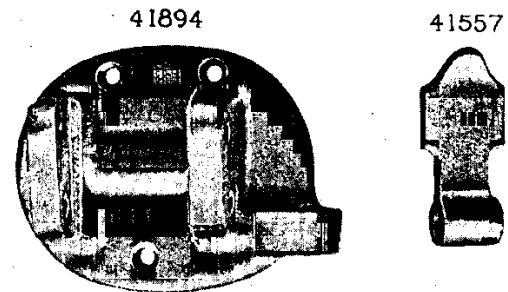
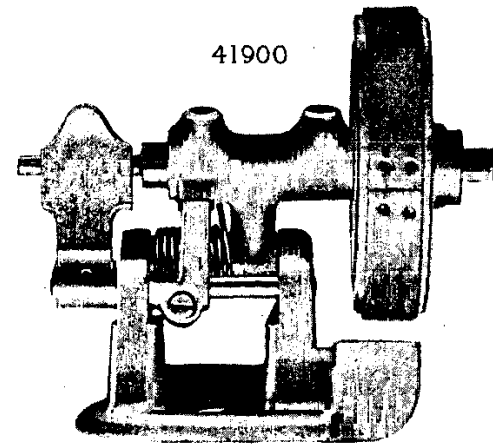

PLATE 7268—FULL SIZE

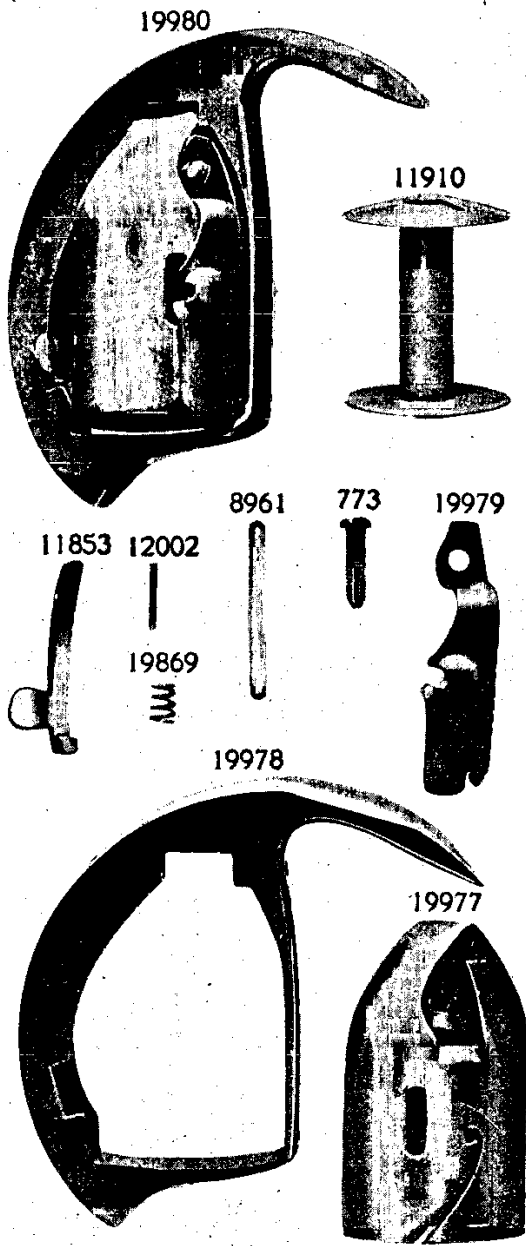

PLATE 7285—ONE-FOURTH SIZE

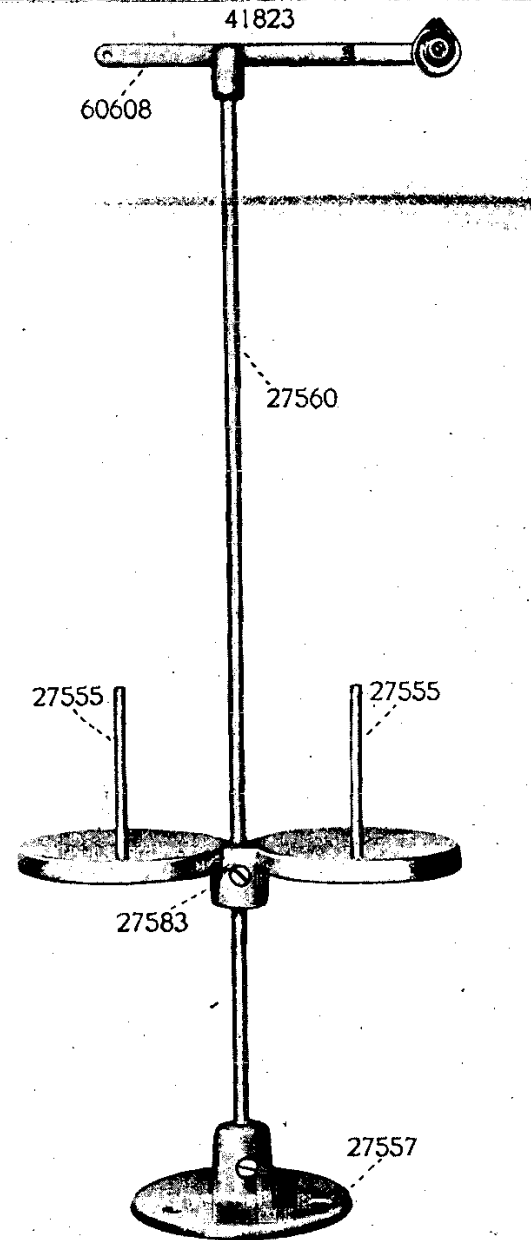

PLATE 7815—ONE-HALF SIZE

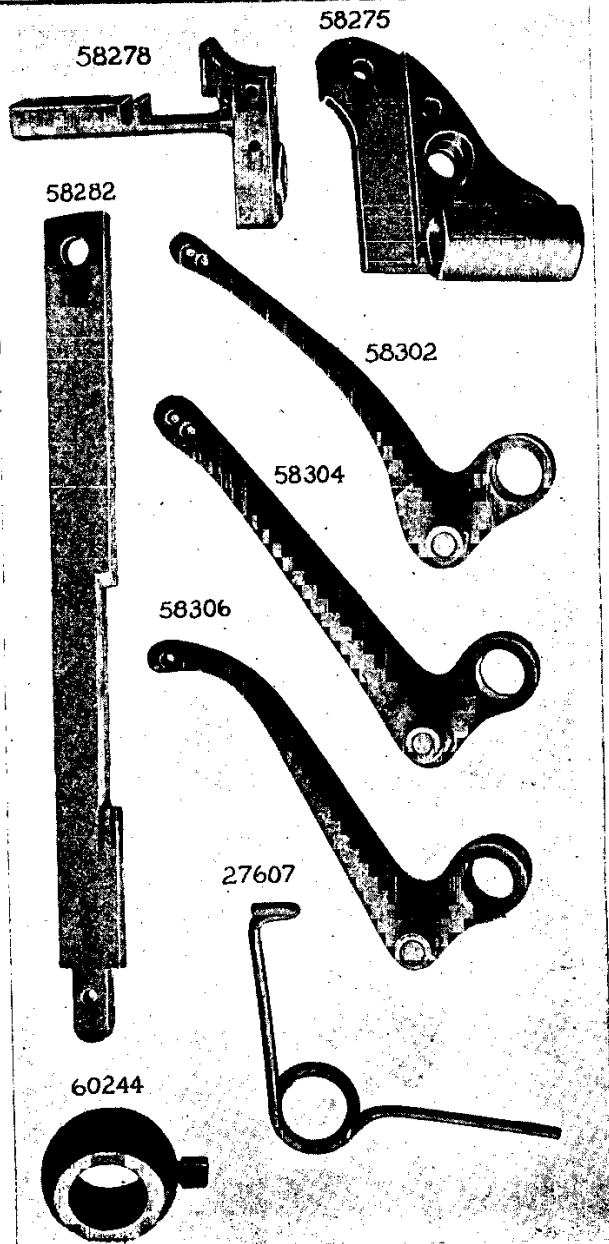
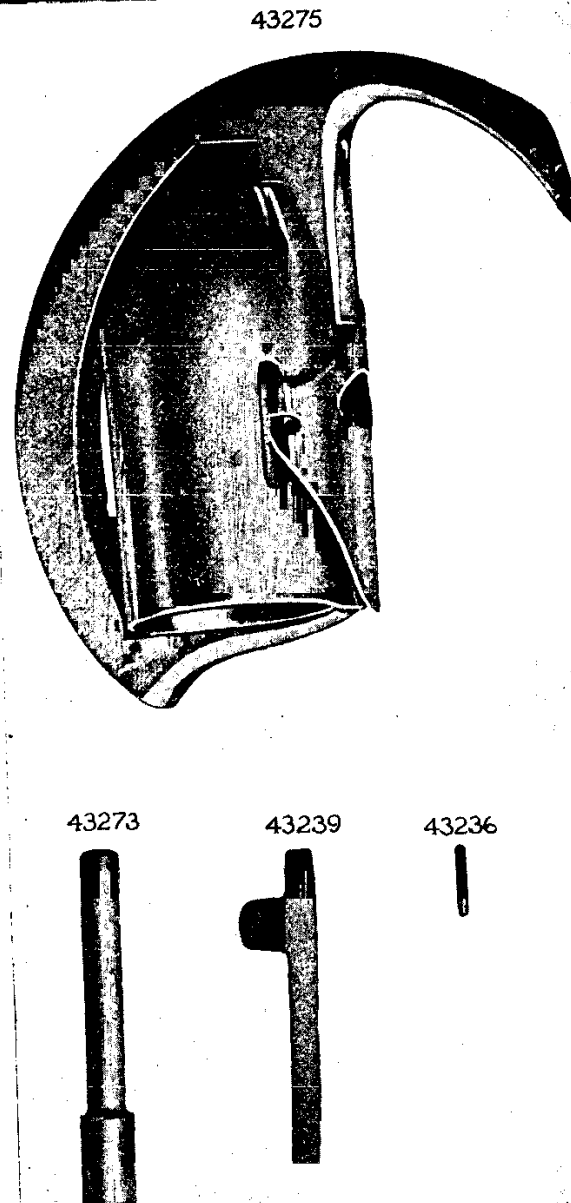

PLATE 7816—FULL SIZE



From the library of: Diamond Needle Corp

PLATE 7817—FULL SIZE

43240

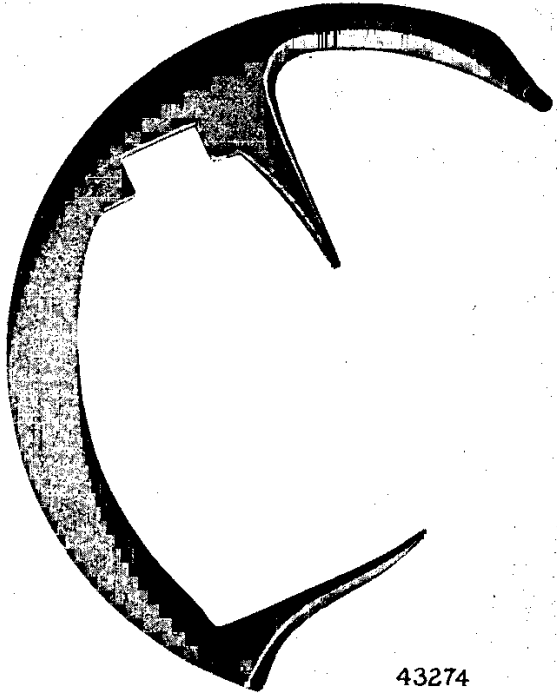

43274

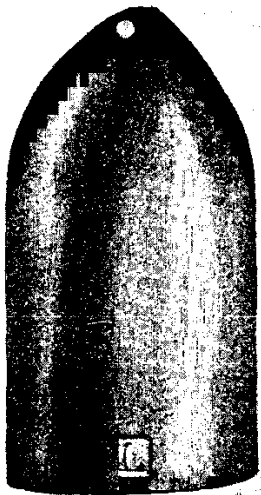
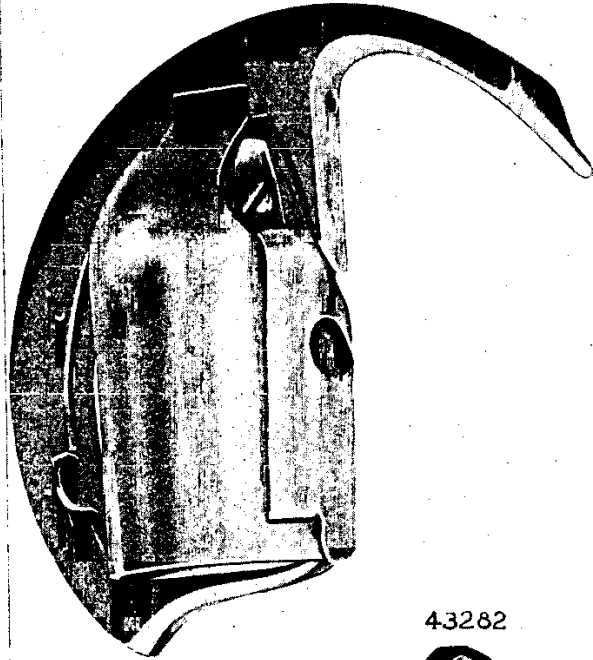
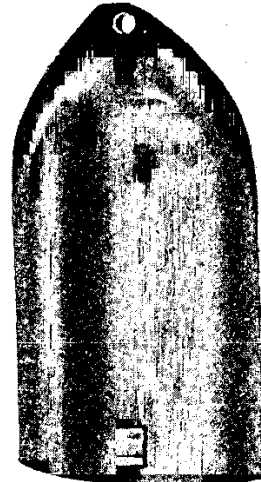

PLATE 7818—FULL SIZE

43283



43282



43235



PLATE 7819—FULL SIZE

43242

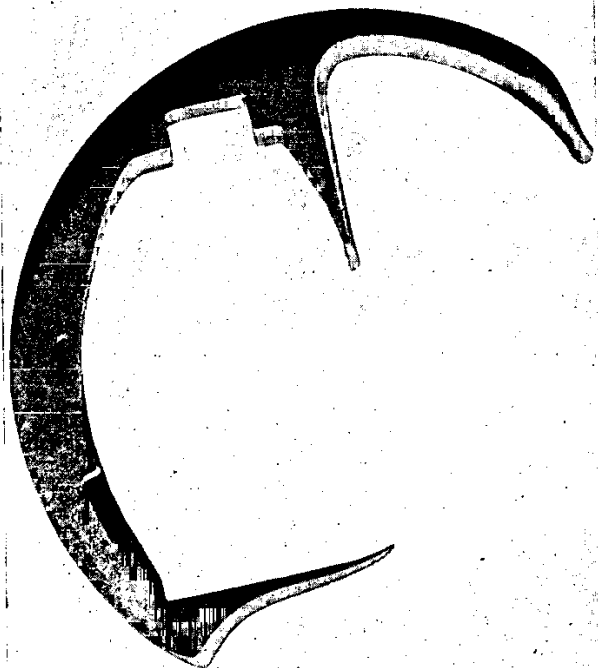
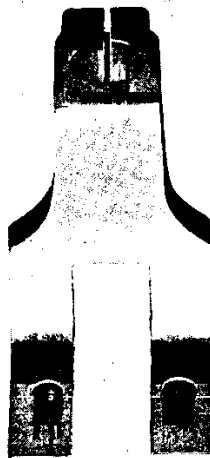
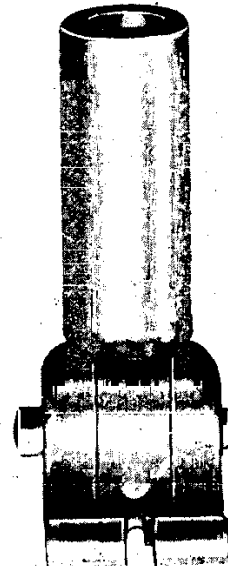

PLATE 7821—FULL SIZE

58276



19708



58283



PLATE 7822—FULL SIZE

43285

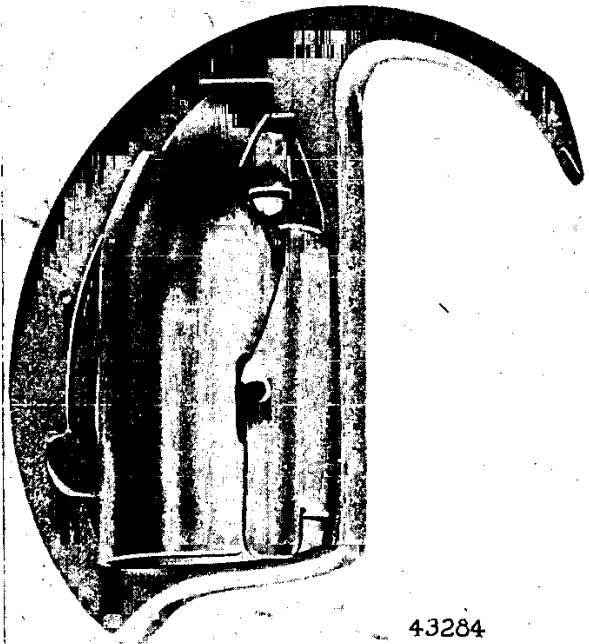

43284



58209



PLATE 7823—FULL SIZE

43260

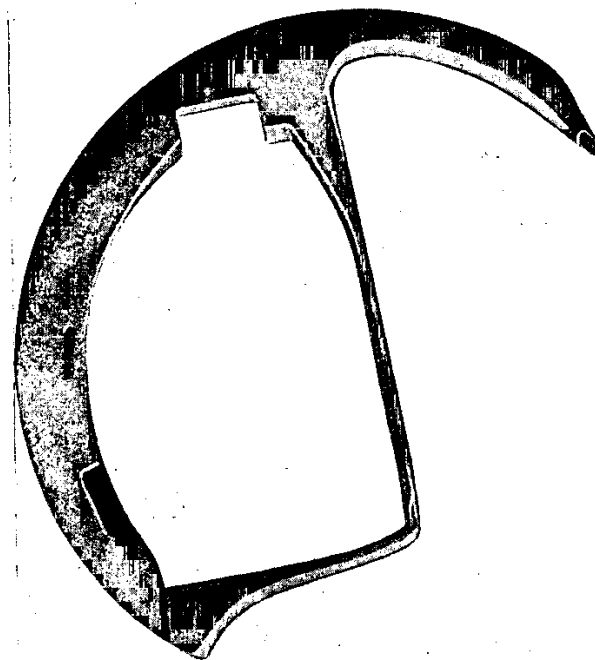
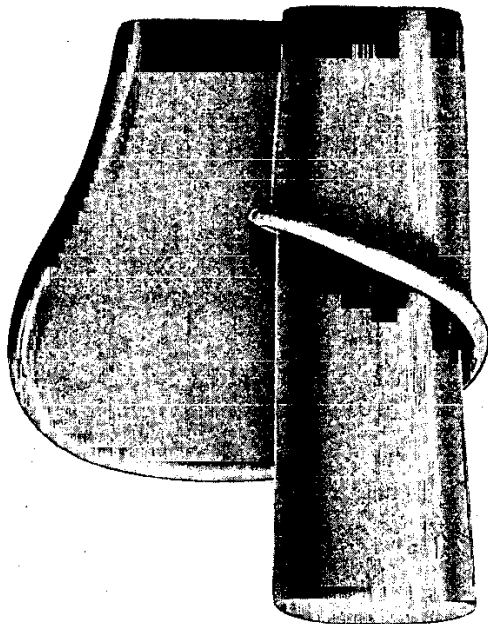

PLATE 7826—ONE-HALF SIZE

120147



120163

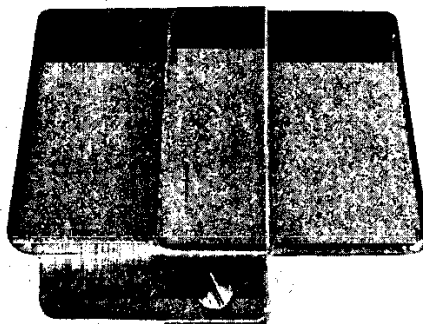

PLATE 7831—ONE-FOURTH SIZE

60288



60293



60292



60289



202468

60294



60636

204126

58264



58263

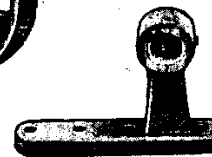

58265



60291

60290



PLATE 7833—ONE-FOURTH SIZE

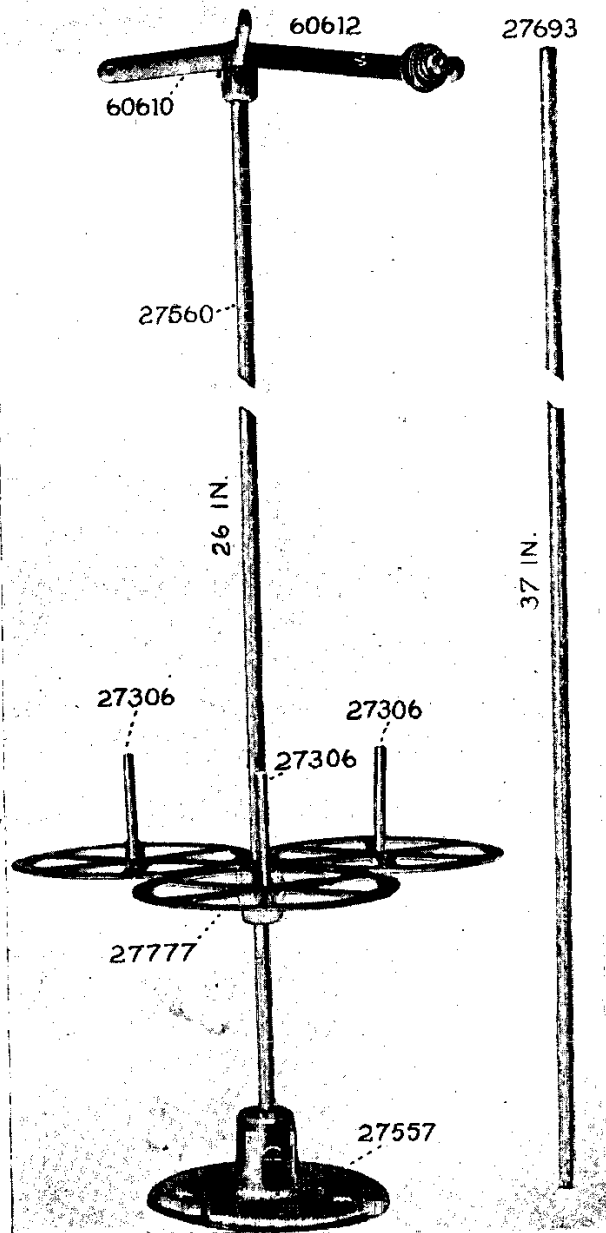

PLATE 7835—ONE-FOURTH SIZE

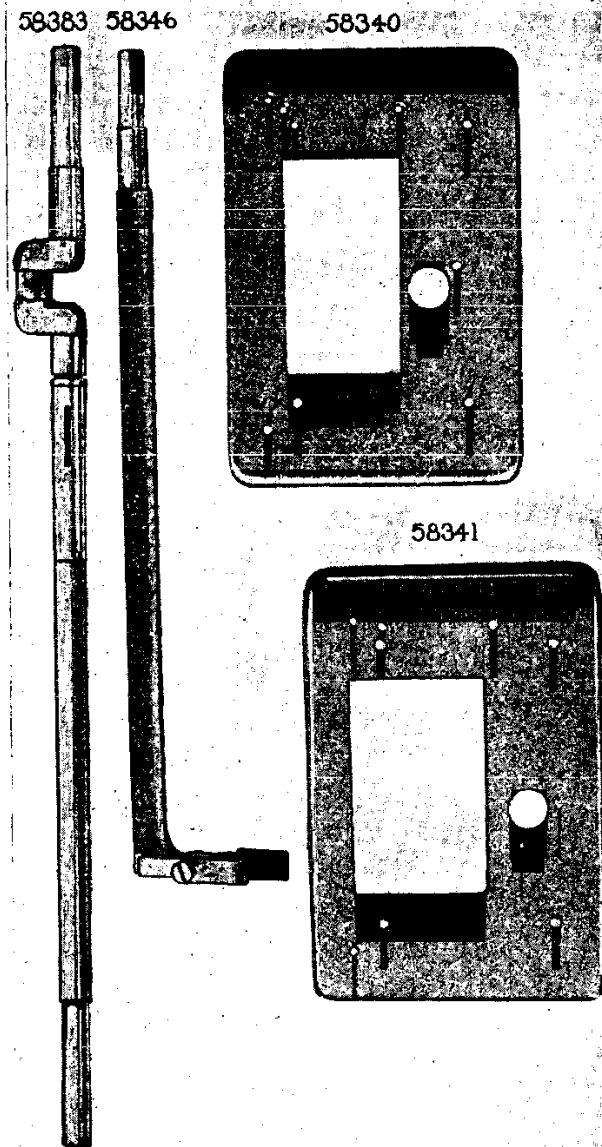
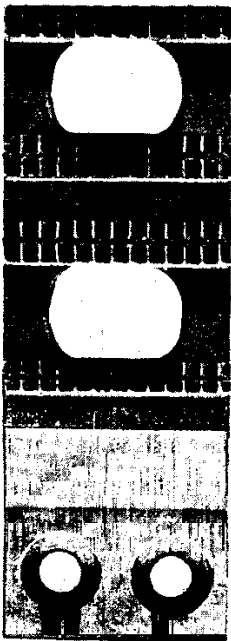

PLATE 7836—FULL SIZE

58342



58352

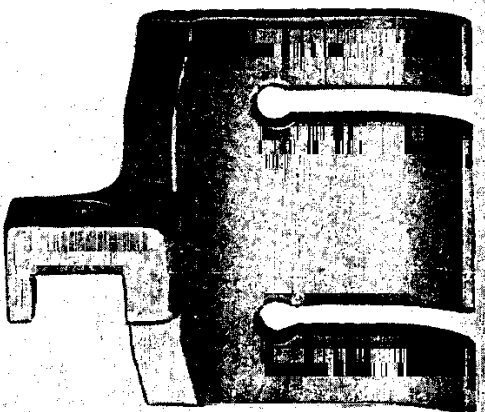

PLATE 7837—FULL SIZE

58369

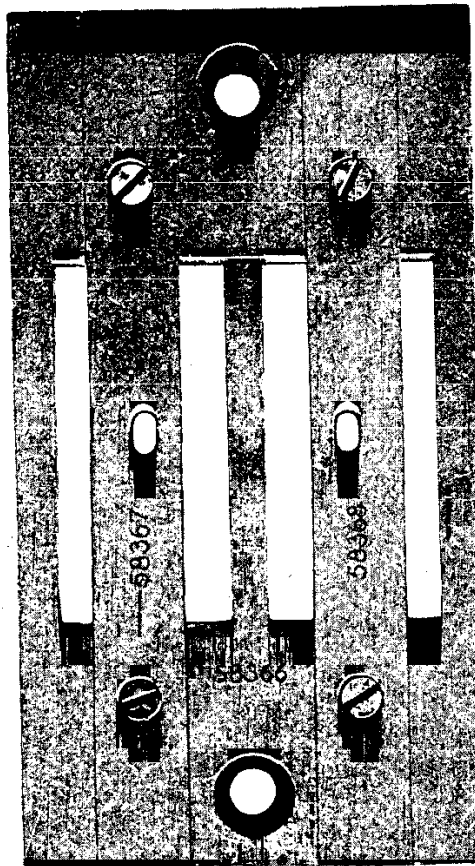
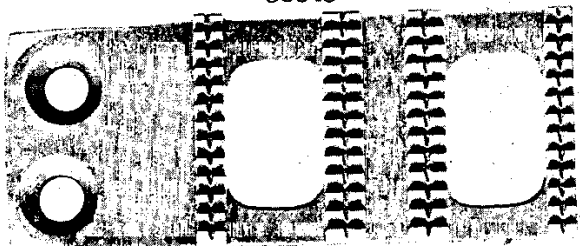

PLATE 7838—FULL SIZE

58343



58371

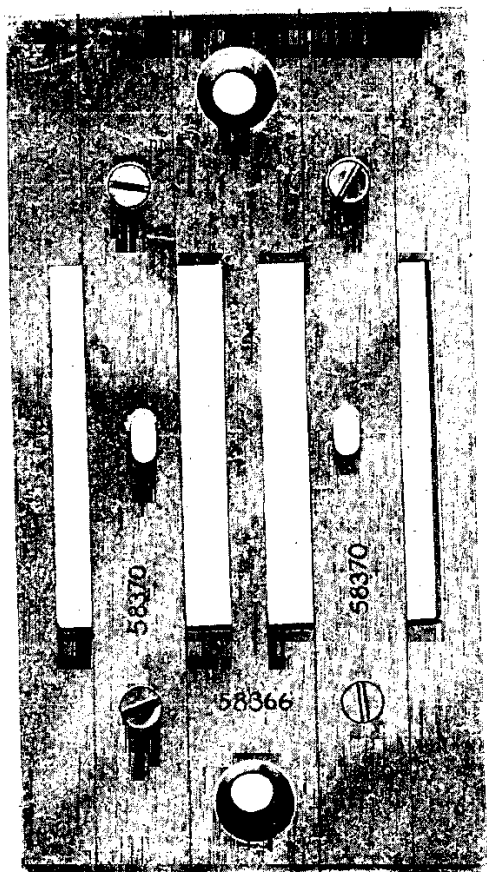
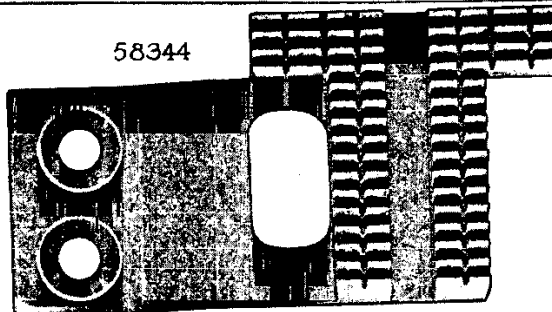

PLATE 7839—FULL SIZE

58344



58375

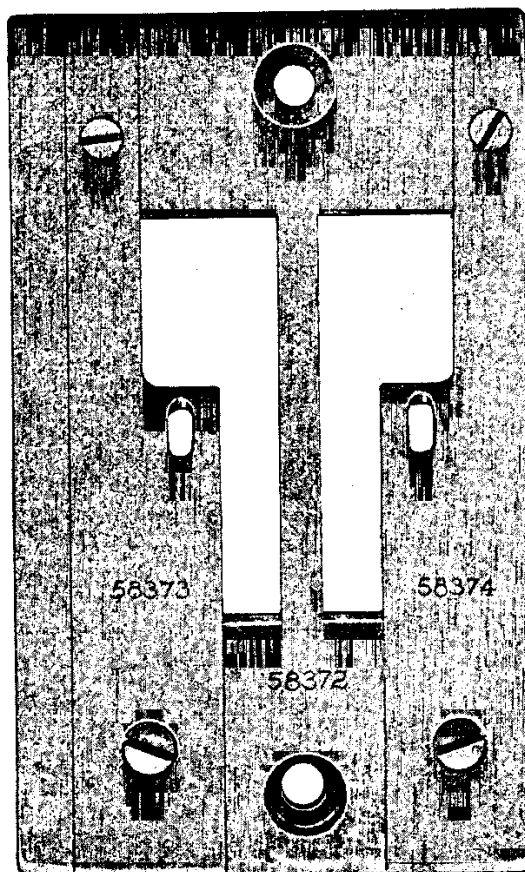
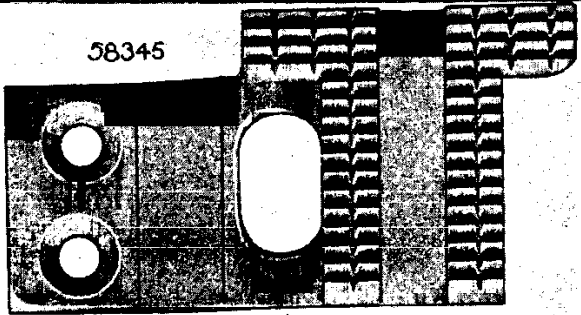
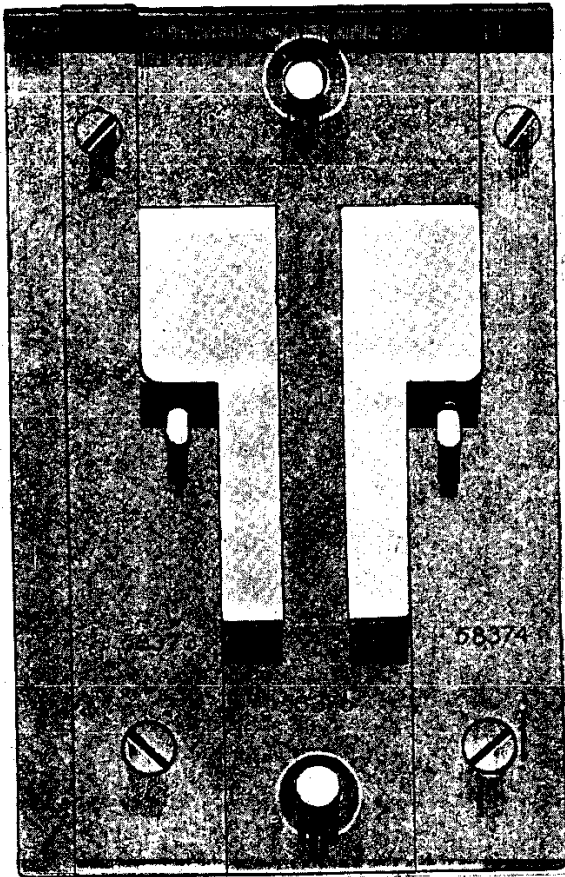

PLATE 7840—FULL SIZE

58345



58377



58374

PLATE 7841—FULL SIZE

58348

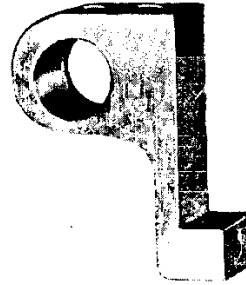

58350



58355



58356



1114

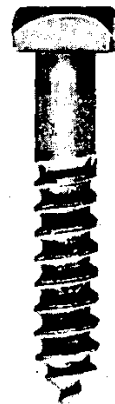

9281

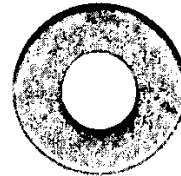
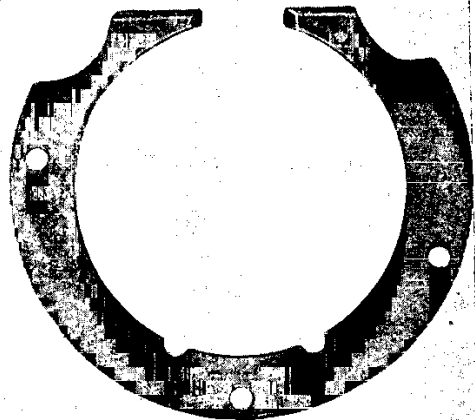

PLATE 7842—ONE-HALF SIZE

58353

58364



58363

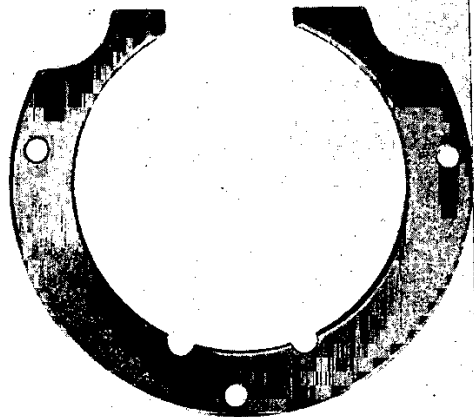

58351

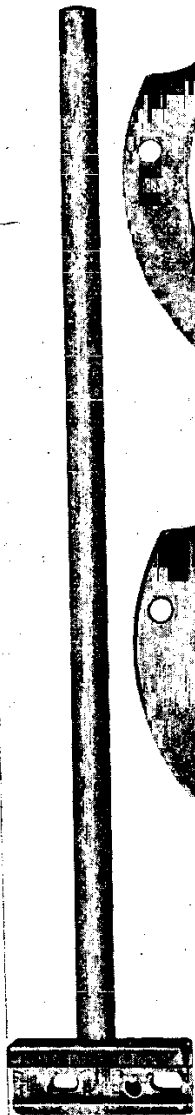
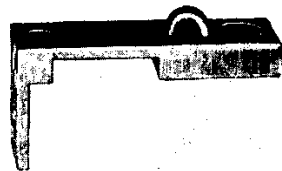
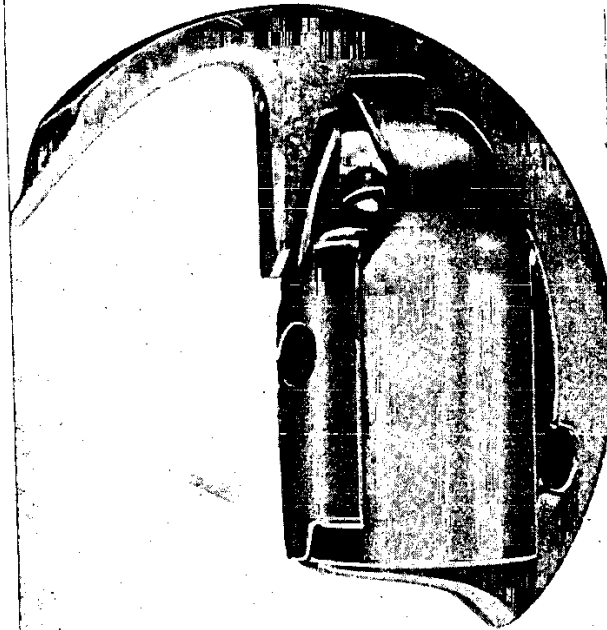

PLATE 7843—FULL SIZE

58358



58357



PLATE 7844—FULL SIZE

58360

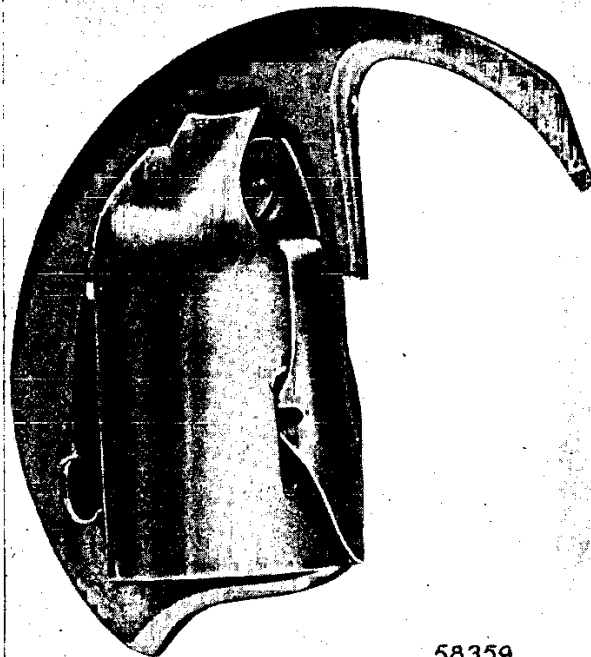

58359

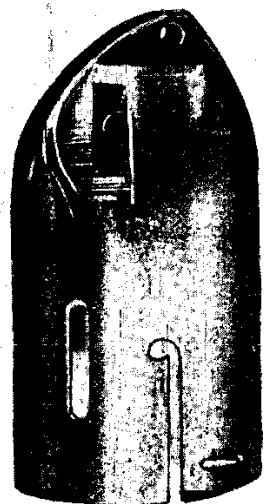
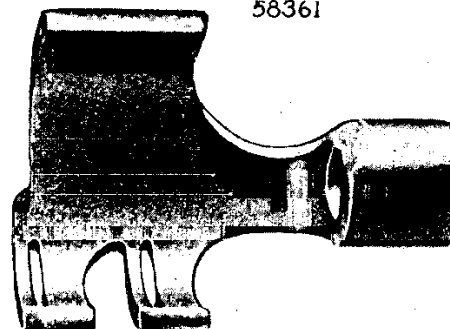

PLATE 7845—ONE-HALF SIZE

58361



58365

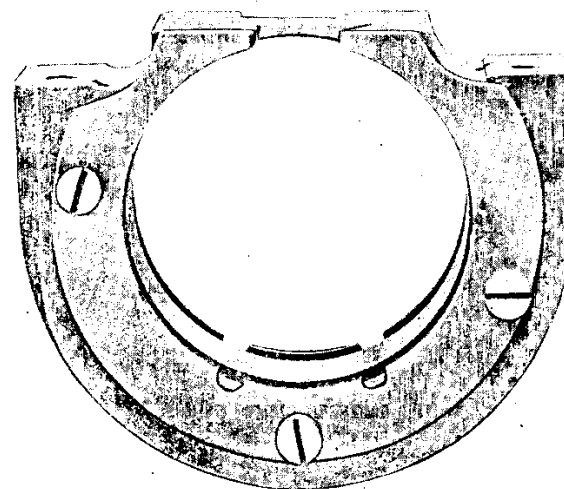

PLATE 9608—FULL SIZE

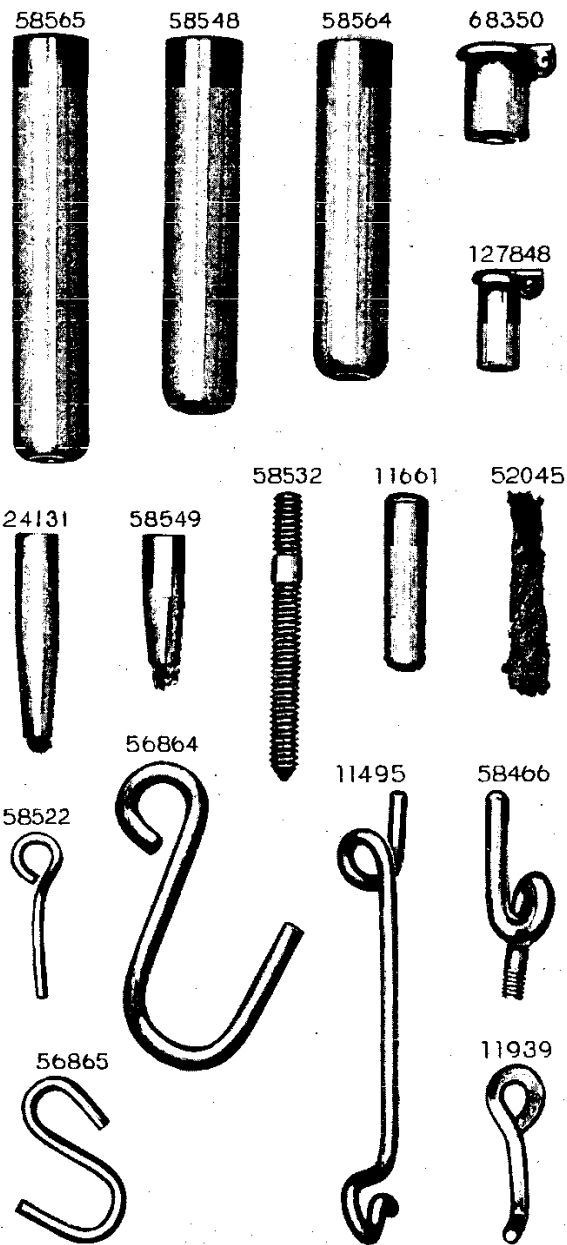

PLATE 9609—ONE-HALF SIZE

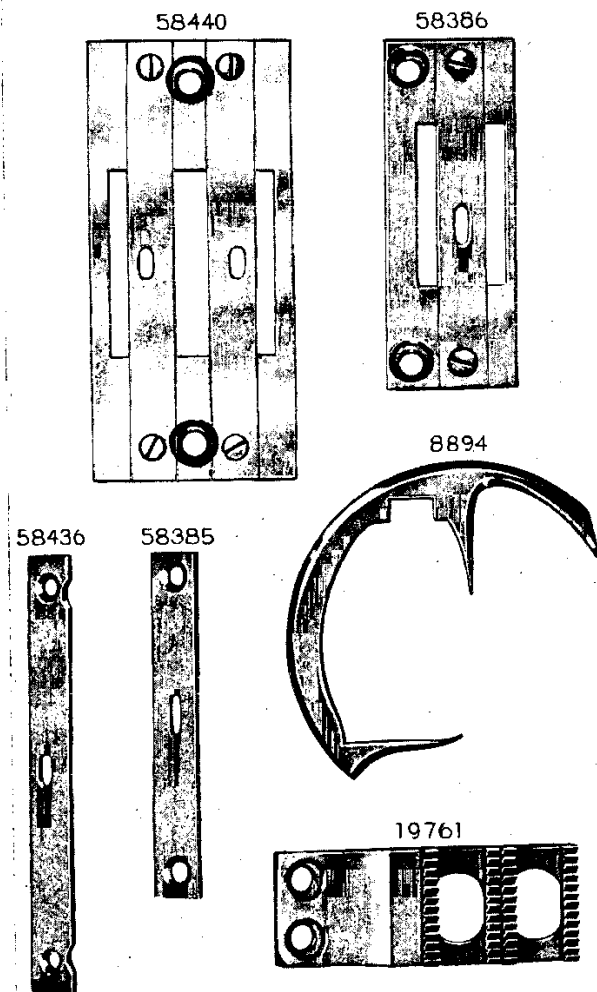

PLATE 9610—ONE-HALF SIZE

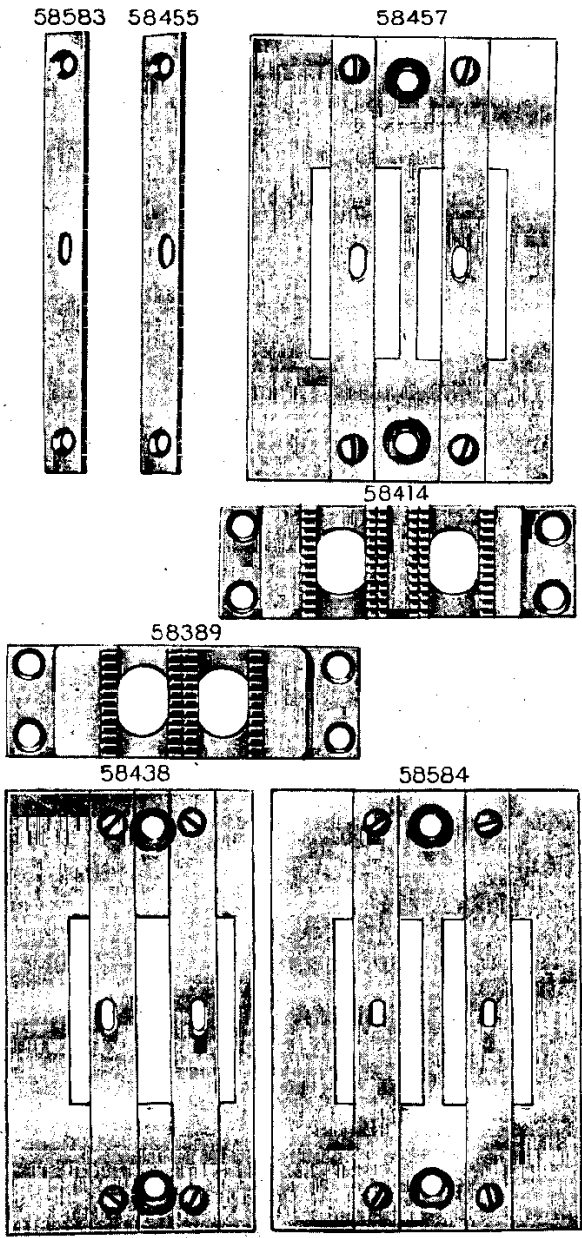

PLATE 9611—FULL SIZE

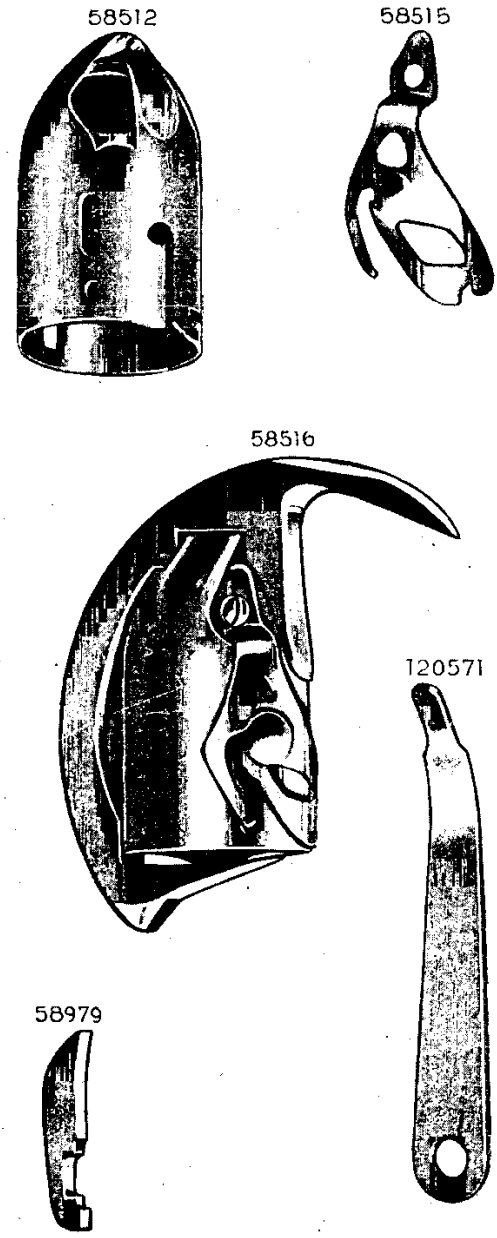
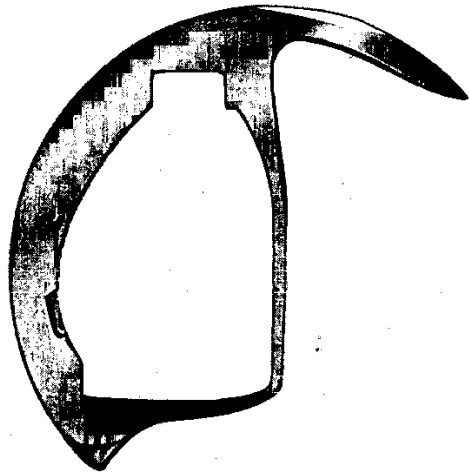
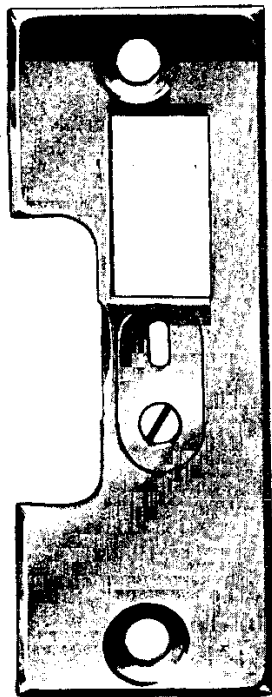

PLATE 9612—FULL SIZE

58523



58543



58542



58539

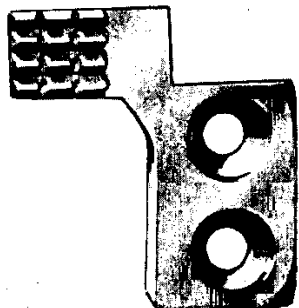
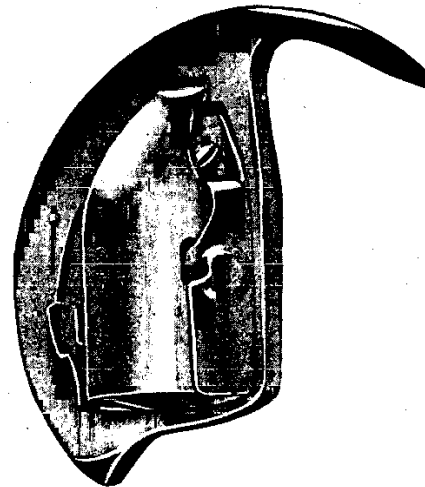

PLATE 9613—FULL SIZE

58525



58526

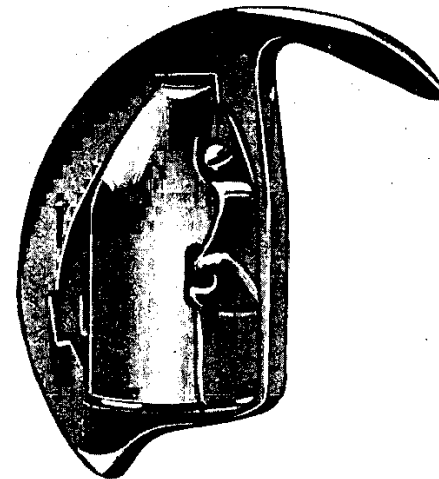
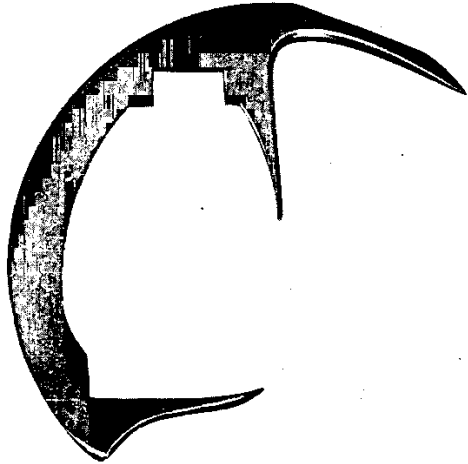

PLATE 9614—FULL SIZE

19573



19574

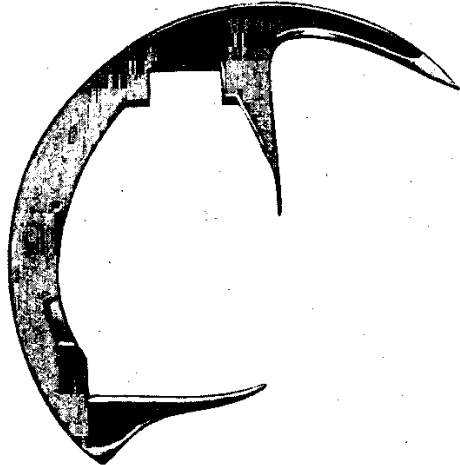
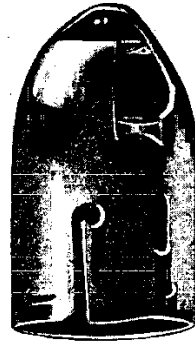

PLATE 9615—FULL SIZE

58517



58520



58521

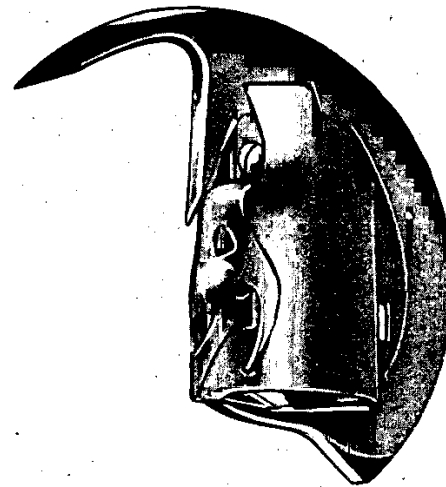

PLATE 9616—FULL SIZE

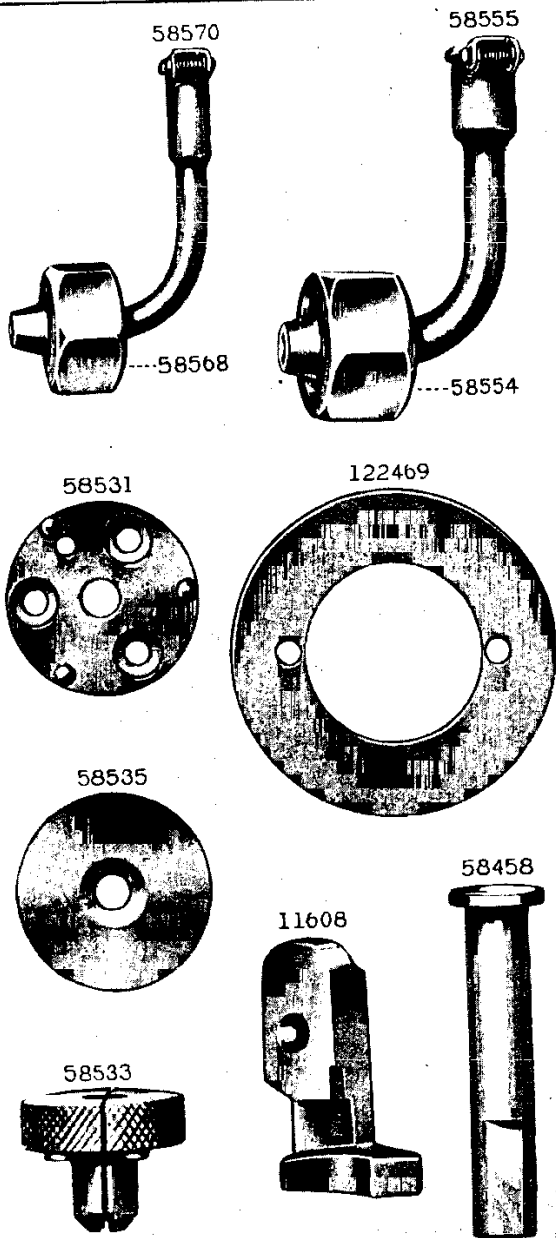

PLATE 9617—FULL SIZE

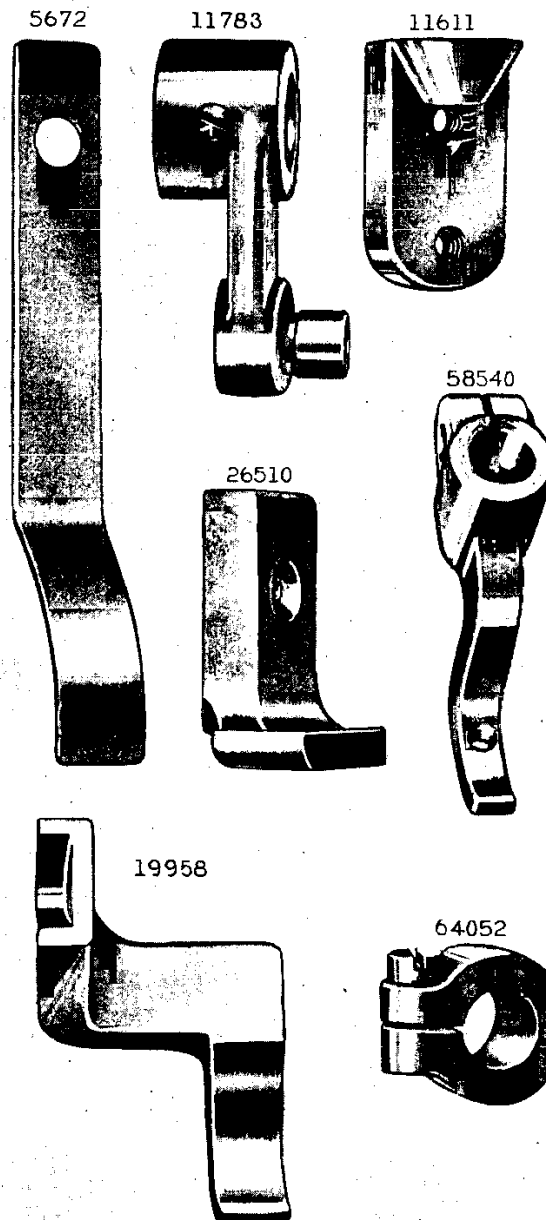

PLATE 9618—FULL SIZE

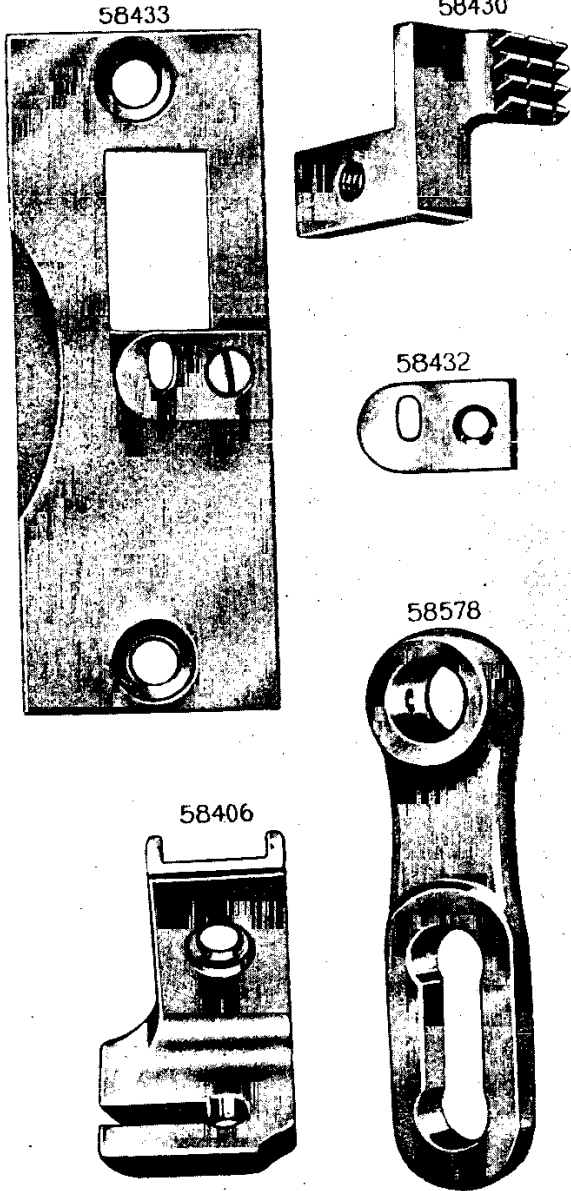

PLATE 9619—FULL SIZE

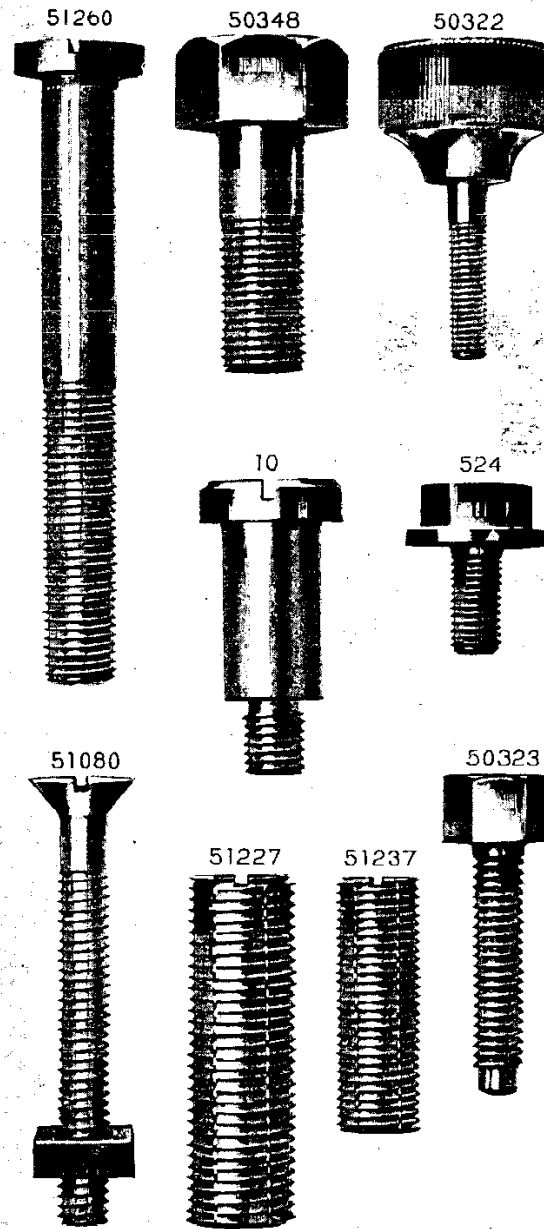

PLATE 9620—FULL SIZE

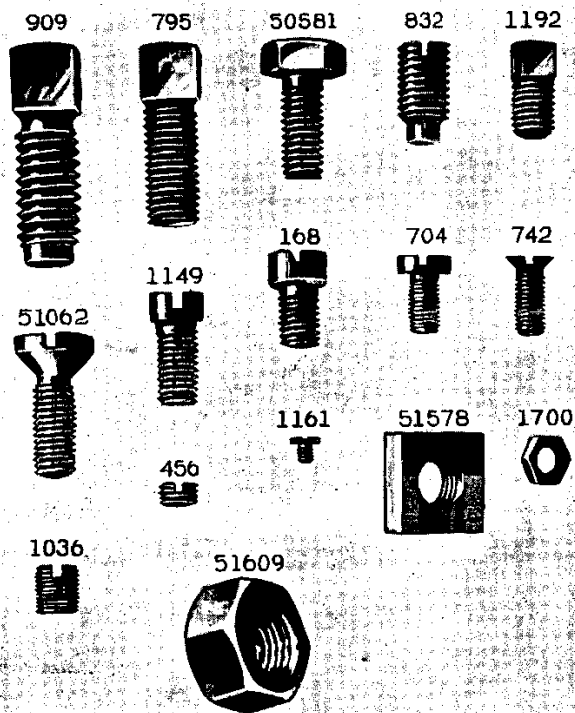

PLATE 9621—FULL SIZE

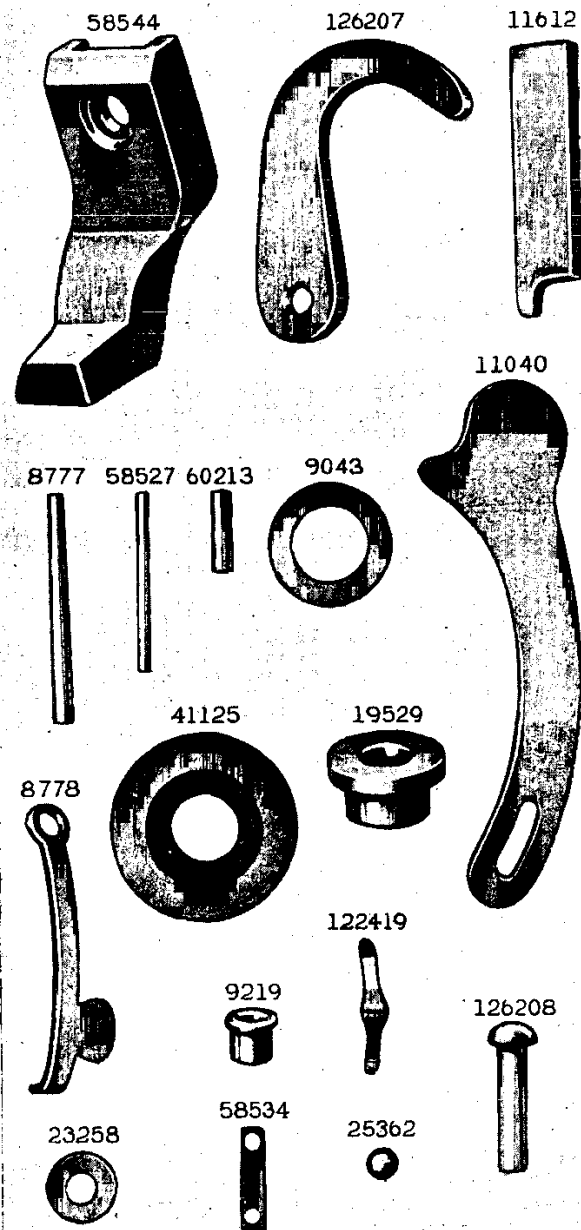
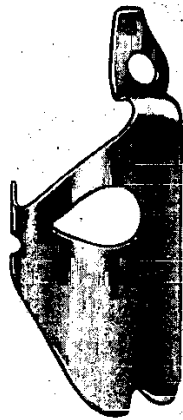

PLATE 9622—FULL SIZE

8900



8895



58381



16901

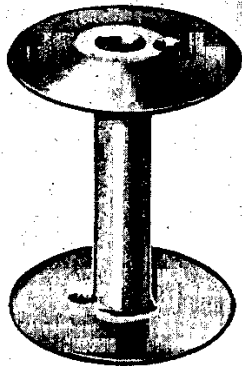
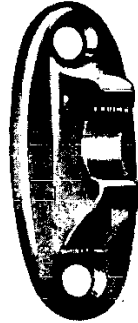

PLATE 9623—ONE-HALF SIZE

126205



46681



126038



58409

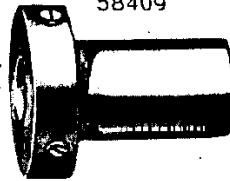

60858



25200



60988

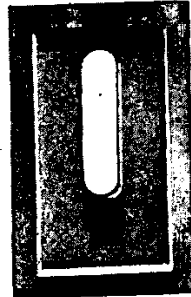

58511

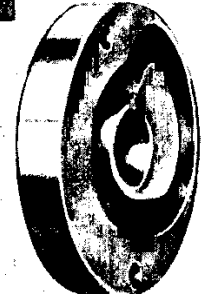
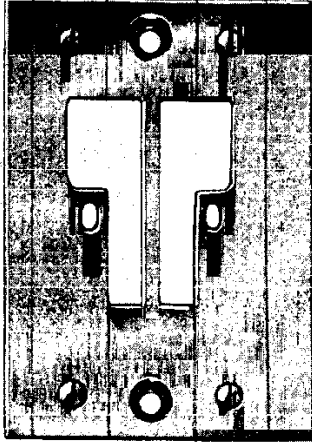

PLATE 9624—ONE-HALF SIZE

58423



58425



58415

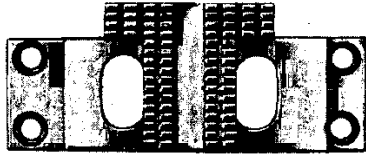

58429

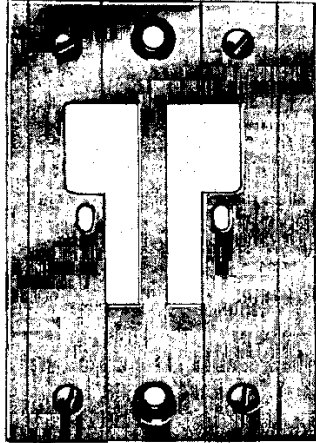

58427



PLATE 9625—ONE-HALF SIZE

58550

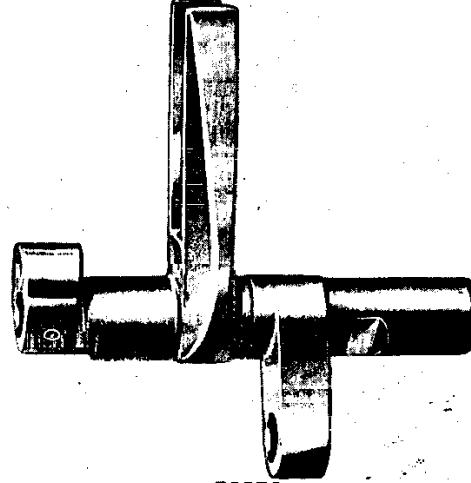

58552



58573

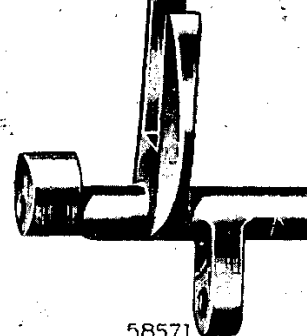

58585



58571

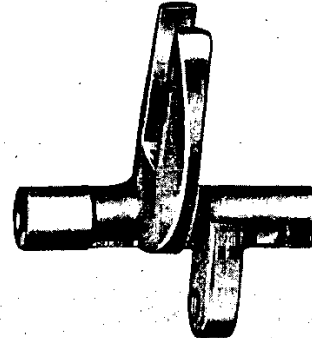

From the library of: Diamond Needle Corp

PLATE 9628—ONE-FOURTH SIZE

58444 58445 19923 58392 58390

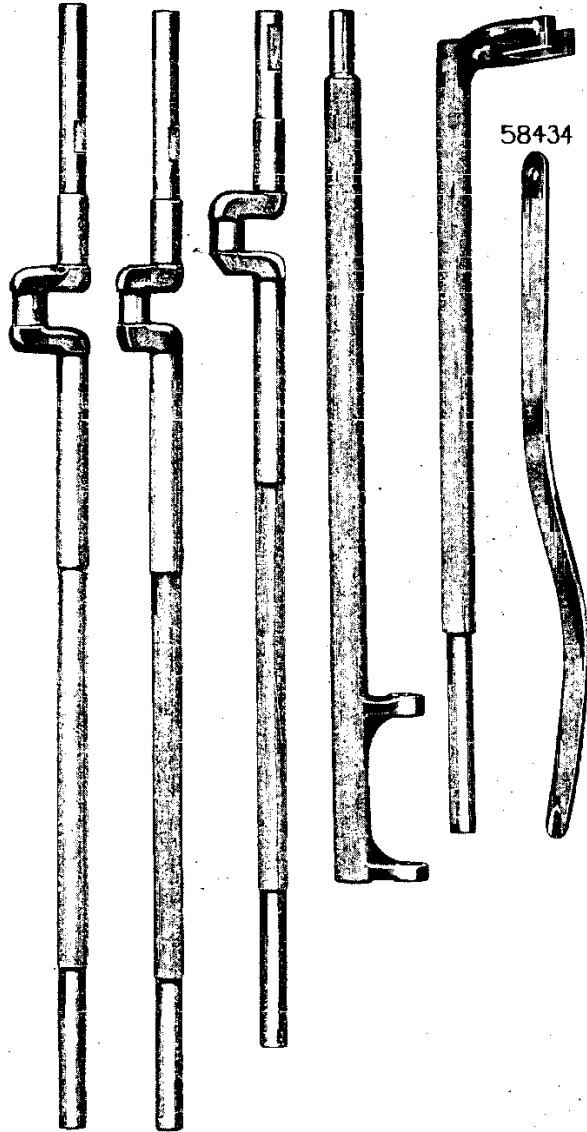

PLATE 9629—ONE-FOURTH SIZE

58387 27640 60626

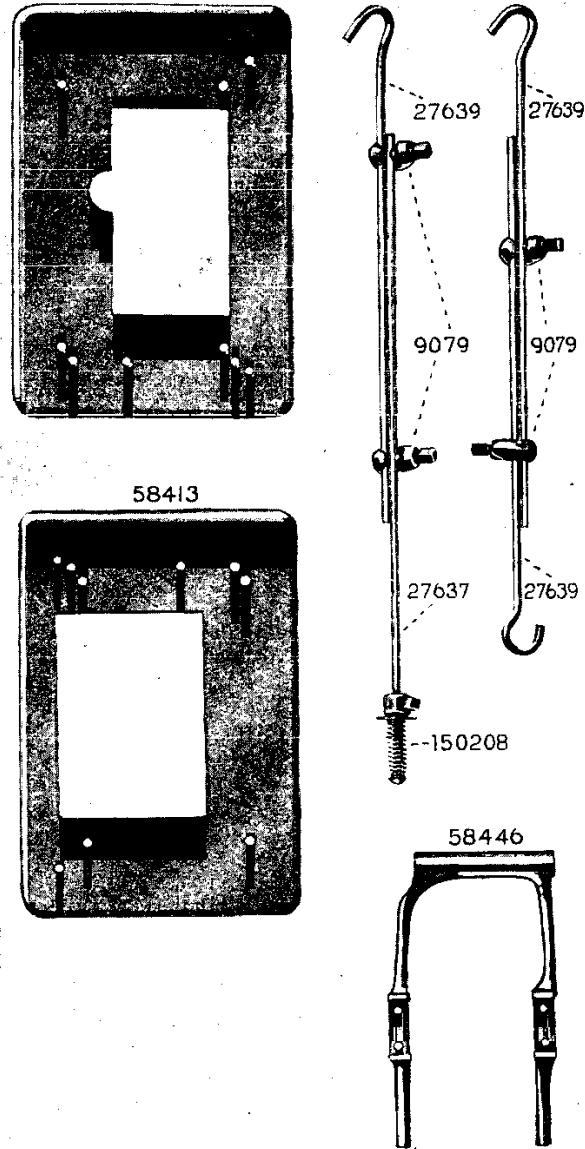
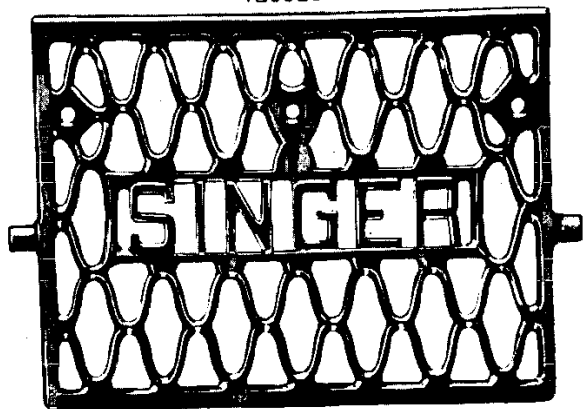
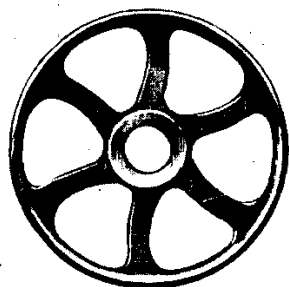

PLATE 9630—ONE-FOURTH SIZE

126036



58408



58462

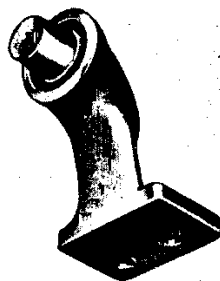

58465

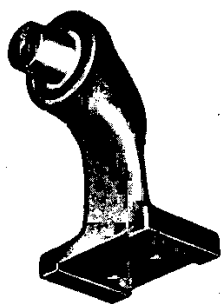

58442

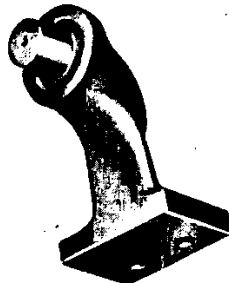
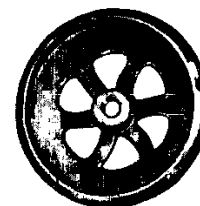
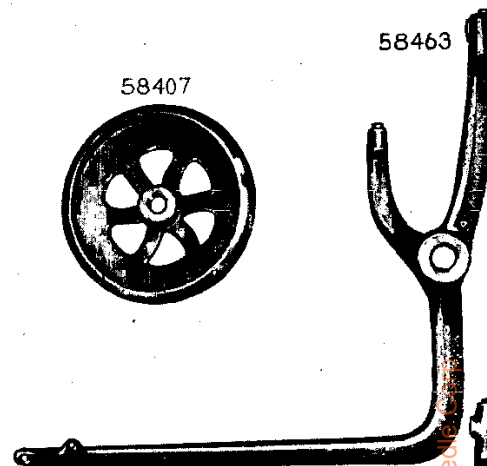

PLATE 9631—ONE-NINTH SIZE

58407



58463



58459

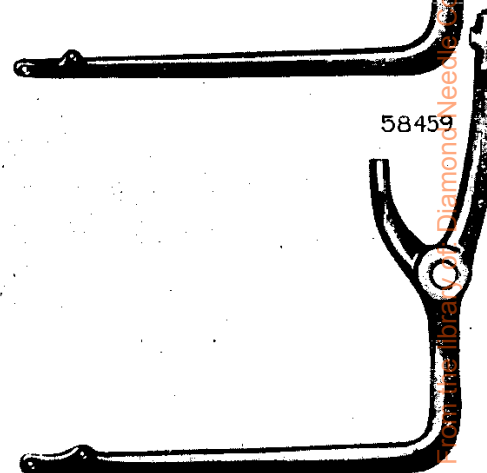

58563

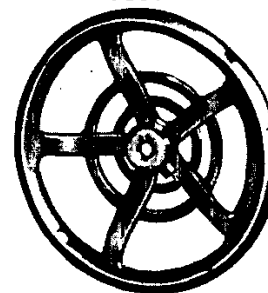

58411

